

Tucson

OWNER'S MANUAL

Operation
Maintenance
Specifications

All information in this Owner's Manual is current at the time of publication. However, HYUNDAI reserves the right to make changes at any time without prior notice and without obligation to incorporate such changes so that our policy of continual product improvement may be carried out.

This manual applies to all models of this vehicle and includes descriptions and explanations of optional as well as standard equipment. As a result, you may find material in this manual that does not apply to your specific vehicle.

This booklet is not intended to be a substitute for the Owner's Manual given in QR Code provided at the backside of the cover page.

CAUTION: MODIFICATIONS TO YOUR HYUNDAI

Your HYUNDAI should not be modified in any way. Such modifications may adversely affect the performance, safety or durability of your HYUNDAI and may, in addition, violate conditions of the limited warranties covering the vehicle. Certain modifications may also be in violation of regulations established by the Department of Transportation and other government agencies in your country.

TWO-WAY RADIO OR CELLULAR TELEPHONE INSTALLATION

Your vehicle is equipped with electronic fuel injection and other electronic components. It is possible for an improperly installed/adjusted two-way radio or cellular telephone to adversely affect electronic systems. For this reason, we recommend that you carefully follow the radio manufacturer's instructions or consult your authorized HYUNDAI dealer for precautionary measures or special instructions if you choose to install one of these devices.

SAFETY AND VEHICLE DAMAGE WARNING

This manual includes information titled as DANGER, WARNING, CAUTION and NOTICE.

These titles indicate the following:



DANGER

DANGER indicates a hazardous situation which, if not avoided, will result in death or serious injury.



WARNING

WARNING indicates a hazardous situation which, if not avoided, could result in death or serious injury.



CAUTION

CAUTION indicates a hazardous situation which, if not avoided, could result in minor or moderate injury.

NOTICE

NOTICE indicates a situation which, if not avoided, could result in vehicle damage.

Table of Contents

Hyundai Warranty Policy	1
Vehicle Information	2
Safety System	3
Convenience Features	4
Driving Your Vehicle	5
Driver Assistance System	6
Emergency Situations	7
Maintenance	8

FOREWORD

Congratulations, and thank you for choosing HYUNDAI. We are pleased to welcome you to the growing number of discerning people who drive HYUNDAI. We are very proud of the advanced engineering and high-quality construction of each HYUNDAI we build.

Your Owner's Manual will introduce you to the features and operation of your new HYUNDAI. To become familiar with your new HYUNDAI, so that you can fully enjoy it, read this Owner's Manual carefully before driving your new vehicle.

This manual contains important safety information and instructions intended to familiarize you with your vehicle's controls and safety features so you can safely operate your vehicle.

This manual also contains information on maintenance designed to enhance safe operation of the vehicle. It is recommended that all service and maintenance on your car be performed by an authorized HYUNDAI dealer. An authorized HYUNDAI dealer are prepared to provide high-quality service, maintenance and any other assistance that may be required.

This Owner's Manual should be considered a permanent part of your vehicle, and should be kept in the vehicle so you can refer to it at any time. The manual should stay with the vehicle if you sell it to provide the next owner with important operating, safety and maintenance information.

HYUNDAI MOTOR COMPANY



CAUTION

Severe engine and transmission damage may result from the use of poor quality fuels and lubricants that do not meet HYUNDAI specifications. You must always use high quality fuels and lubricants that meet the specifications listed in the Vehicle Specifications section of the Owner's Manual.

Copyright 2023 HYUNDAI Motor Company. All rights reserved. No part of this publication may be reproduced, stored in any retrieval system or transmitted in any form or by any means without the prior written permission of HYUNDAI Motor Company.

FUEL REQUIREMENTS

Gasoline engine

Unleaded

Your new vehicle is designed to perform optimally using unleaded fuel having an Octane Rating of RON (Research Octane Number) 91 / AKI (Anti-Knock Index) 87 or higher. (Do not use methanol blended fuels)

Your new vehicle is designed to obtain maximum performance with UNLEADED FUEL, as well as minimize exhaust emissions and spark plug fouling.

NOTICE

NEVER USE LEADED FUEL. The use of leaded fuel is detrimental to the catalytic converter and will damage the engine control system's oxygen sensor and affect emission control.

Also, severe wear and crack of piston ring, valve, etc. may occur and knocking noise may be heard from your engine.

Never add any fuel system cleaning agents to the fuel tank other than what has been specified (We recommend that you consult an authorized HYUNDAI dealer for details.)



WARNING

- Do not "top off" after the nozzle automatically shuts off when refueling.
- Always check that the fuel cap is installed securely to prevent fuel spillage in the event of an accident.

Gasoline containing alcohol and methanol

Gasohol, a mixture of gasoline and ethanol (also known as grain alcohol), and gasoline or gasohol containing methanol (also known as wood alcohol) are being marketed along with or instead of leaded or unleaded gasoline.

Do not use gasohol containing more than 20% ethanol, and do not use gasoline or gasohol containing any methanol. Either of these fuels may cause drivability problems and damage to the fuel system, engine control system and emission control system.

Discontinue using gasohol of any kind if drivability problems occur.

Vehicle damage or driveability problems may not be covered by the manufacturer's warranty if they result from the use of:

1. Gasohol containing more than 20% ethanol.
2. Gasoline or gasohol containing methanol.
3. Leaded fuel or leaded gasohol.

NOTICE

Never use gasohol which contains methanol. Discontinue use of any gasohol product which impairs drivability.

Using Fuel Additives

Using fuel additives such as:

- Silicone fuel additive
- MMT (Manganese, Mn) fuel additive
- Ferrocene (iron-based) fuel additive
- Other metallic-based fuel additives

May result in cylinder misfire, poor acceleration, engine stalling, engine plugging, heavy knocking noise, damage to the catalyst, or abnormal corrosion, and may cause damage to the engine resulting in a reduction in the overall life of the powertrain. The Malfunction Indicator Lamp (MIL) may illuminate.

NOTICE

Damage to the fuel system or performance problem caused by the use of these fuels may not be covered by your New Vehicle Limited Warranty.

Use of MTBE

HYUNDAI recommends avoiding fuels containing MTBE (Methyl Tertiary Butyl Ether) over 15.0% vol. (Oxygen Content 2.7% weight) in your vehicle.

Fuel containing MTBE over 15.0% vol. (Oxygen Content 2.7% weight) may reduce vehicle performance and produce vapor lock or hard starting.

NOTICE

Your New Vehicle Limited Warranty may not cover damage to the fuel system and any performance problems that are caused by the use of fuels containing methanol or fuels containing MTBE (Methyl Tertiary Butyl Ether) over 15.0% vol. (Oxygen Content 2.7% weight.)

Do not use methanol

Fuels containing methanol (wood alcohol) should not be used in your vehicle. This type of fuel can reduce vehicle performance and damage components of the fuel system, engine control system and emission control system.

Fuel Additives

HYUNDAI recommends that you use unleaded gasoline which has an octane rating of RON (Research Octane Number) 95 / AKI (Anti Knock Index) 91 / AKI (Anti-Knock Index) 87 or higher.

For customers who do not use good quality gasolines, and have problems starting or the engine does not run smoothly, one bottle of additive added to the fuel tank is recommended according to the maintenance schedule (**refer to chapter 9, "Normal Maintenance Schedule"**).

Additives are available from your authorized HYUNDAI dealer along with information on how to use them. Do not mix other additives.

Operation in foreign countries

If you are going to drive your vehicle in another country, be sure to:

- Observe all regulations regarding registration and insurance.
- Determine that acceptable fuel is available.

Diesel engine

Diesel fuel

Diesel engine must be operated only on commercially available diesel fuel that complies with EN 590 or comparable standard. (EN stands for “European Norm”). Do not use marine diesel fuel, heating oils, or non-approved fuel additives, as this will increase wear and cause damage to the engine and fuel system.

The use of non-approved fuels and/or fuel additives will result in a limitation of your warranty rights.

Diesel fuel of above cetane 51 is used in your vehicle. If two types of diesel fuel are available, use summer or winter fuel properly according to the following temperature conditions.

- Above -5°C (23°F) ... Summer type diesel fuel.
- Below -5°C (23°F) ... Winter type diesel fuel.

Watch the fuel level in the tank very carefully : If the engine stops through fuel failure, the circuits must be completely purged to permit restarting.

NOTICE

Do not let any gasoline or water enter the tank. This would make it necessary to drain it out and to bleed the lines to avoid jamming the injection pump and damaging the engine.

NOTICE

Diesel Fuel (if equipped with DPF)

It is recommended to use regulated automotive diesel fuel for diesel vehicle equipped with the DPF system. If you use diesel fuel including high sulfur (more than 10 ppm sulfur) and unspecified additives, it can cause the DPF system to be damaged and white smoke can be emitted.

Biodiesel

Commercially supplied Diesel blends of no more than 7% biodiesel, commonly known as “B7 Diesel” may be used in your vehicle if Biodiesel meets EN 14214 or equivalent specifications. (EN stands for “European Norm”). The use of biofuels exceeding 7% made from rapeseed methyl ester (RME), fatty acid methyl ester (FAME), vegetable oil methyl ester (VME) etc., or mixing diesel exceeding 7% with biodiesel will cause increased wear or damage to the engine and fuel system. Repair or replacement of worn or damaged components due to the use of non approved fuels will not be covered by the manufactures warranty.

NOTICE

- **Never use any fuel that fails to meet the latest petroleum industry specification.**
- **Never use any fuel additives or treatments that are not recommended or approved by the vehicle manufacturer.**

VEHICLE MODIFICATIONS

- This vehicle should not be modified. Modification of your vehicle could affect its performance, safety or durability and may even violate governmental safety and emissions regulations.

In addition, damage or performance problems resulting from any modification may not be covered under warranty.

- If you use unauthorized electronic devices, it may cause the vehicle to operate abnormally, wire damage, battery discharge and fire. For your safety, we recommend that you do not use unauthorized electronic devices.

NOTICE

Some warning sounds (including welcome/good-bye sound, Road Active Noise Control, etc.) are generated from the exterior amplifiers. If necessary, we recommend you to purchase HYUNDAI Parts to replace an exterior amplifier. Any unauthorized product may cause a malfunction of the exterior amplifiers.

VEHICLE HANDLING INSTRUCTIONS

As with other vehicles of this type, failure to operate this vehicle correctly may result in loss of control, an accident or vehicle rollover.

Specific design characteristics (higher ground clearance, track, etc.) give this vehicle a higher center of gravity than other types of vehicles. In other words they are not designed for cornering at the same speeds as conventional 2-wheel drive vehicles. Avoid sharp turns or abrupt maneuvers. Again, failure to operate this vehicle correctly may result in loss of control, an accident or vehicle rollover. Be sure to read the “Reducing the risk of a rollover” driving guidelines, in section 5 of this manual.

VEHICLE BREAK-IN PROCESS

By following a few simple precautions for the first 1,000 km (600 miles) you may add to the performance, economy and life of your vehicle.

- Do not race the engine.
- While driving, avoid sudden acceleration.
- Do not maintain a single speed for long periods of time, either fast or slow. Varying engine speed is needed to properly break-in the engine.
- Avoid hard stops, except in emergencies, to allow the brakes to seat properly.
- Do not tow a trailer during the first 2,000 km (1,200 miles) of operation.
- Fuel economy and engine performance may vary depending on vehicle break-in process and be stabilized after 6,000 km (4,000 miles). New engines may consume more oil during the vehicle break-in period.

1. Hyundai Warranty Policy

- Hyundai New Vehicle Warranty1-2
- Replacement Parts Warranty1-3
- Hyundai Extended Warranty1-5
- Labour Free Service of Vehicle1-5
- Hyundai Road Side Assistance1-6
- Labour Free Service Coupons.....1-7

HYUNDAI NEW VEHICLE WARRANTY

Hyundai Motor India Limited hereinafter called "HMIL", warrants that each new Hyundai vehicle sold shall be free from any defects in material and workmanship, under normal use and maintenance, subject to the following terms and conditions.

1. Warranty Period

This warranty for Hyundai vehicle shall exist for a period of 36 months from the date of delivery to the first purchaser irrespective of the mileage. However the warranty for Hyundai vehicle being used for commercial purpose such as Taxi/Tourist operation is 36 months/100,000 Kms from the date of delivery to the first purchaser which soever is earlier. This warranty is transferable to subsequent owner for the remaining warranty period. This warranty is applicable only in India and not transferable to any other country.

2. What is covered

Except as provided in paragraph 3 hereof, our Authorized Dealers shall either repair or replace, any Hyundai genuine part that is acknowledged by HMIL to be defective in material or workmanship within the warranty period stipulated above, at no cost to the owner of the Hyundai vehicle for parts or labour. Such defective parts which have been replaced will become the property of HMIL

3. What is not covered

This warranty shall not apply to:

- ▶ Normal maintenance services other than the three labour free services, including without limitation, cleaning and polishing, minor adjustments, engine tuning, oil/fluid changes, filters replenishment, fastener retightening, wheel balancing, wheel alignment and tyre rotation etc.
- ▶ Replacement of parts as a result of normal wear and tear such as spark plugs, belts, brake pads and linings, clutch disc/facing, filters, wiper blades, bulbs, fuses, etc.

Damage or failure resulting from :

- ▶ Negligence of proper maintenance as required in this Owner's Manual and Service Booklet.
- ▶ Misuse, abuse, accident, theft, flooding or fire.
- ▶ Use of improper or insufficient fuel, fluids or lubricants.
- ▶ Use of parts other than Hyundai Genuine Parts.
- ▶ Any device and/or accessories not supplied by HMIL.
- ▶ Modifications, alterations, tampering or improper repair.
- ▶ Parts used in applications of which they were not designed or not approved by HMIL.
- ▶ Slight irregularities not recognised as affecting quality or function of the vehicle or parts, such as slight noise or vibrations, or items considered characteristic of the vehicle.
- ▶ Airborne "fallout", Industrial fallout, acid rain, hail and windstorms, or other Acts of God.

- ▶ Paint scratches, dents or similar-paint or body damage.
- ▶ Action of road elements (sand,-gravel, dust or road debris) which results in stone chipping of paint or glass.
- ▶ Incidental or consequential damages, including without limitation, loss of time, inconvenience, loss of use of vehicle or commercial loss.

Wireless Charger, Air Purifier, Batteries, Tyres & Tubes, or any external accessory originally equipped on Hyundai vehicles are warranted directly by the respective manufacturers and not by HMIL.

- ▶ This warranty is the entire warranty given by HMIL for Hyundai vehicles and no dealer or its or his agent or employee is authorized to extend or enlarge this warranty and no dealer or its or his agent or employee is authorized to make any oral warranty on HMIL's behalf.
- ▶ HMIL reserves the right to make any change in design or make any improvement on the vehicle at any time without any obligation to make the same change on vehicles previously sold.
- ▶ HMIL reserves the right for the final decision in all warranty matters.

Owner's Responsibilities

- ▶ Proper use, maintenance and care of vehicle in accordance with the instructions contained in this Owner's Manual and Service Booklet. If the vehicle is subject to severe usage conditions, su-

such as operation in extremely dusty, rough, more repeated short distance driving or heavy city traffic during hot weather, maintenance of vehicle should be done more frequently as mentioned in this Owner's Manual and Service Booklet

- ▶ Retention of maintenance service records. It may be necessary for the customer to show that the required maintenance has been performed, as specified in this Owner's Manual and Service Booklet.
- ▶ Delivery of the vehicle during regular service business hours to any authorized Hyundai Dealer to obtain warranty service.
- ▶ In order to maintain the validity of this Basic Warranty, the vehicle must be serviced by Hyundai Authorized workshop in accordance to the Owner's Manual and Service Booklet.

PARTS REPLACEMENT WARRANTY

Hyundai Motor India Limited hereinafter called "HMIL", warrants that each new Hyundai Genuine replacement part purchased from and installed by Hyundai Authorized Dealer shall be free from any defects in material or workmanship, under normal use and maintenance, subject to the following terms and conditions

1. Warranty period

This warranty shall exist for a period of 6 months or until the vehicle has

been driven for a distance of 10,000 Kilometers from the date of installation of replacement part by Hyundai Authorized Dealer, whichever occurs first.

2. What is covered

Our Authorized Dealers shall either repair or replace, any Hyundai genuine part listed in paragraph 3 hereof, that is acknowledged by HMIL to be defective in material or workmanship within the warranty period stipulated above, after examinations carried out to confirm that none of the original settings have been tampered with, at no cost to the owner of the Hyundai vehicle for parts or labour. Such defective parts which have been replaced will become the property of HMIL

3. What is not covered

This warranty shall not apply to:

- Normal maintenance services of parts such as cleaning, adjustment or replacement (i.e. spark plugs that are oil fouled, lead fouled, or which fail due to the use of low grade fuel).
- Parts that fail due to abuse, misuse, neglect, alteration or accident or which have been improperly lubricated or repaired
- Parts used in applications for which they were not designed or approved by HMIL.
- Failure due to normal wear of parts.
- Direct or indirect failures caused by misuse and improper maintenance of vehicle.

- Any vehicle on which the odometer reading has been altered so that mileage cannot be accurately determined.
- Incidental or consequential damages, including without limitation, loss of time, inconvenience, loss of use of vehicle or commercial loss.

This warranty is the entire warranty given by HMIL for Hyundai replacement parts and no dealer or its agent or employee is authorized to extend or enlarge this warranty and no dealer or its agent or employee is authorized to make any oral warranty on HMIL's behalf. HMIL reserves the right for the final decision in all warranty matters.

Owner's Responsibility :

- Proper use, maintenance and care of the vehicle in accordance with the instructions contained in the Owner's Manual and Service Booklet.
- Retention of maintenance service records. It may be necessary for the customer to show that the required maintenance has been performed, as specified in this Owner's Manual and Service Booklet.
- **Retention of the customer's copy of the original repair order and its invoice/bill against which the part was replaced.**
- Delivery of the vehicle during regular service business hours to the same Hyundai Authorized Dealer who had sold and installed the replacement part
- In order to maintain the validity

of this Parts replacement Warranty, the vehicle must be serviced by Hyundai Authorized workshop in accordance to the Owner's Manual and Service Booklet.

HYUNDAI EXTENDED WARRANTY*

HML offers optional paid extended warranty on selected models, in addition to the basic new vehicle warranty. For more details on Hyundai Extended Warranty please call the nearest dealer or our toll free number 1-800-11-4645.

Or Visit our Hyundai Website

www.hyundai.co.in

** Conditions apply*

Labour Free Service of Vehicle

Your vehicle is entitled for first three labour free services of Periodic Maintenance Schedule (PMS). Please refer page 2-7 for labour free service coupons and page 2-8 for PMS services.

NOTICE :

All Consumables, Wheel Alignment and / or Part Replacement (if not covered in warranty), if required are chargeable to the customer(s).

We are pleased to introduce you to our 24 X 7 Hyundai Road Side Assistance Programme

**Our Road Side Assistance number is : 1800 102 4645 (toll free),
(0124)2564645 (call charges apply)**

Hyundai Roadside assistance is a 24 X 7 emergency support provided in the event of any mechanical/electrical breakdown and/or road traffic accident of a vehicle.

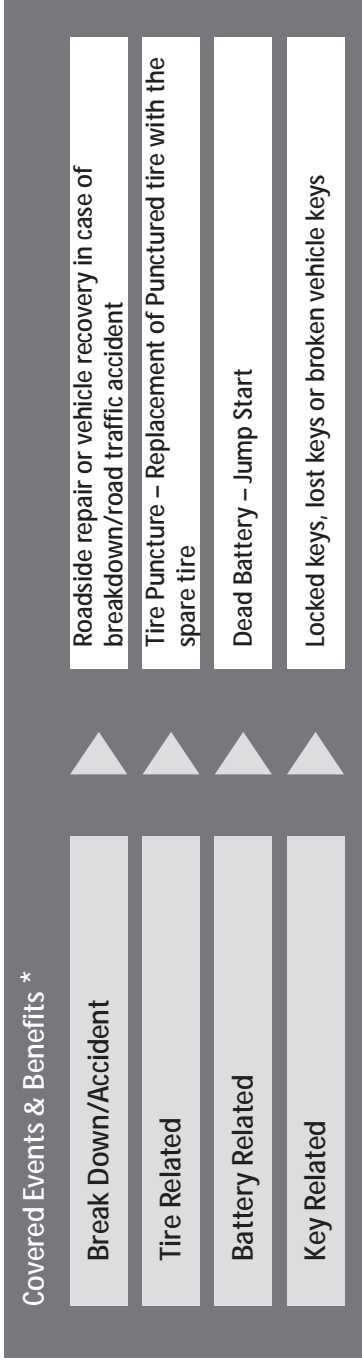

* Terms and Conditions apply.

Terms and Conditions

- 1) The Service is applicable for 3 years from the date of sale
- 2) The 24 X 7 Road Side Assistance is available up to a nearest Hyundai Authorised dealer workshop
- 3) The Service is applicable for a condition in which the vehicle has been immobile
- 4) Cost of parts replacement is not included, unless covered under Hyundai Warranty
- 5) Cost of repairs made to your vehicle is not included, unless it is covered under Hyundai Warranty.
- 6) For Online retail RSA & Complete TnC's, kindly visit: <https://hyundai.aawassistance.in/>

**1st Labour Free Service
Coupon**

(9,000-10,000 km or within 12 months of
delivery, whichever is earlier)

Customer Copy

Model Name _____
Customer's Name _____
VIN _____
Registration No. _____
Mileage _____
Delivery Date _____
Service Date _____
RO Number _____
Dealer/HASC code _____

Servicing Dealer's Stamp

Service Mgr's Signature _____

**2nd Labour Free Service
Coupon**

(19,000-20,000 km or within 24 months of
delivery whichever is earlier)

Customer Copy

Model Name _____
Customer's Name _____
VIN _____
Registration No. _____
Mileage _____
Delivery Date _____
Service Date _____
RO Number _____
Dealer/HASC code _____

Servicing Dealer's Stamp

Service Mgr's Signature _____

**3rd Labour Free Service
Coupon**

(29,000-30,000 km or within 36 months of
delivery whichever is earlier)

Customer Copy

Model Name _____
Customer's Name _____
VIN _____
Registration No. _____
Mileage _____
Delivery Date _____
Service Date _____
RO Number _____
Dealer/HASC code _____

Servicing Dealer's Stamp

Service Mgr's Signature _____

CHECK LIST FOR FREE SERVICE 1,500 KM - 20,000 KM

A - ADD I - INSPECT C - CLEAN R - REPLACE L - LUBRICATE I (R) - INSPECT IF REQUIRED TR - TYRE ROTATION
(AFTER INSPECTION, ADD, REPAIR OR REPLACE IF NECESSARY)

No.	Item Description	1st Service		2nd Service		3rd Service	
		Reqd.	Done	Reqd.	Done	Reqd.	Done
A ENGINE BAY							
1	Engine oil & filter*	I	I	R	-	R	-
2	Engine Timing Chain / belt	-	-	-	-	-	-
3	Air cleaner filter (Petrol only)*	-	-	C	-	C	-
4	Air cleaner filter (T-Gdi only)*	-	-	-	-	-	-
5	Air cleaner Filter (Diesel only)*	-	-	C	-	R	-
6	Battery condition & specific gravity	I	I	I	-	I	-
7	Throttle body (Petrol only)	-	-	C	-	C	-
8	Spark plugs (Petrol only)	-	-	C	-	C	-
9	Valve clearance	I (R)	I (R)	I (R)	-	I (R)	-
10	Hoses (Vaccum/ EGR/ VGT/ WGT)	-	-	I	-	I	-
11	Crankcase ventilation hose	I	I	I	-	I	-
12	Tensioner/idler/damper pulley	I (R)	I (R)	I (R)	-	I (R)	-
13	Power steering fluid and leakages**	-	-	-	-	-	-
14	Brake/Clutch fluid	I	I	I	-	I	-
15	Engine coolant	I	I	I	-	I	-
16	Manual transaxle fluid	-	-	-	-	-	-
17	Automatic/CVT/IVT/DCT/IVT transaxle fluid**	-	-	-	-	-	-
B VEHICLE ON FLOOR							
18	Wiper (wiper blade, washer fluid)	I	I	I	-	I	-
19	Brake/Clutch (free play & leakages)	I	I	I	-	I	-
20	Fuel filler cap	-	-	I	-	I	-
21	Climate control air filter*	-	-	C	-	R	-
22	Check AC system (refrigerant/compressor)	I	I	I	-	I	-
23	Cooling system & leakage	I	I	I	-	I	-
C VEHICLE ON LIFT							
24	4WD Shaft differential Transfer case oil**	-	-	-	-	-	-
25	Steering gear rack, linkage and boots	I	I	I	-	I	-
26	Exhaust system	I	I	I	-	I	-
27	Fuel filter (Petrol only)	-	-	-	-	-	-
28	Fuel filter cartridge (Diesel only)*	-	-	-	-	-	-
29	Charcoal Canister (Petrol only)	-	-	-	-	-	R
30	Fuel tank air filter (if equipped) (Petrol only)**	-	-	-	-	-	-
31	Front & rear suspension (linkages & ball joints)	I	I	I	-	I	-
32	Fuel lines, hoses and connections	I	I	I	-	I	-
33	Driveshafts & boots	I	I	I	-	I	-
34	Fluid leakages	I	I	I	-	I	-
35	Front and rear wheel bearing & bushes	I (R)	I (R)	I (R)	-	I (R)	-
36	Front and rear disc/drum brakes & pads	I	I	I	-	I	-
37	Parking brake (disc, shoe & operation)	I	I	I	-	I	-
38	Wheel alignment & balancing*	-	-	I (R)	-	I (R)	-
39	Tyre pressure, condition & rotation*	-	-	I, TR	-	I, TR	-
D. FINAL CHECKS							
40	Bolt and nuts on chassis and body	I	I	I	-	I	-
41	Lubricate locks & hinges	I	I	L	-	L	-
42	All electrical systems (drive belts, alternator)	I	I	I	-	I	-
43	Warning lights operation & GDS system check	I	I	I	-	I	-
44	Ext & int. lights, horn & gauges	I	I	I	-	I	-
45	Sumoof operation (if equipped)	C	C	C	-	C	-
46	All seat belt operation	I	I	I	-	I	-
47	Road test	I (R)	I (R)	I (R)	-	I (R)	-

* All consumables are chargeable to the customer(s)

**If Applicable

- 1st Service - 1,500 km/2 months
- 2nd Service - 10,000 km/12 months
- 3rd Service - 20,000 km/24 months

2. Vehicle Information

Exterior overview (I).....	2-2
Exterior overview (II).....	2-3
Interior overview.....	2-4
Instrument panel overview.....	2-5
Engine compartment.....	2-6
Dimensions.....	2-8
Engine.....	2-8
Bulb wattage.....	2-9
Tires and wheels.....	2-10
Load and speed capacity tires.....	2-11
Air conditioning system.....	2-11
Gross vehicle weight.....	2-12
Luggage volume.....	2-12
Recommended lubricants and capacities.....	2-13
Recommended engine oil.....	2-15
Recommended SAE viscosity number.....	2-15
Vehicle Identification Number (VIN).....	2-16
Vehicle certification label.....	2-16
Tire specification and pressure label.....	2-16
Engine number.....	2-17
Air conditioner compressor label.....	2-17
Declaration of conformity.....	2-17
Fuel label.....	2-18
Gasoline engine.....	2-18
Diesel engine.....	2-18

EXTERIOR OVERVIEW (I)

■ Front view



1. Hood.....	5-41	5. Panorama sunroof	5-36
2. Front lamp.....	9-65	6. Front windshield wiper blades	9-34
3. Tires and wheels.....	2-10, 9-42	7. Windows	5-31
4. Outside rearview mirror	5-30	8. Front radar	7-2

EXTERIOR OVERVIEW (II)

■ Rear view

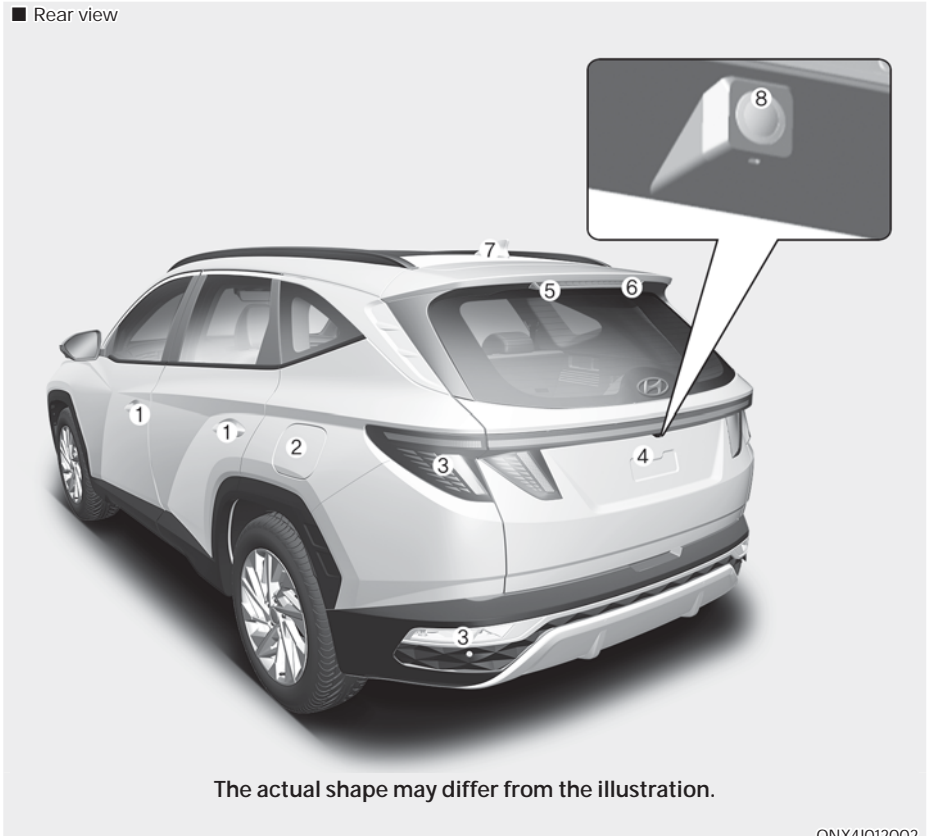

The actual shape may differ from the illustration.

ONX4I012002

- | | | | |
|-------------------------------|------|----------------------------------|-------|
| 1. Door..... | 5-13 | 5. High mounted stop lamp..... | 9-74 |
| 2. Fuel filler door..... | 5-52 | 6. Rear window wiper blades..... | 9-36 |
| 3. Rear combination lamp..... | 9-71 | 7. Antenna..... | 5-112 |
| 4. Tailgate..... | 5-42 | 8. Wide-rear view camera..... | 7-77 |

INTERIOR OVERVIEW



- | | |
|--|--------------------------------------|
| 1. Inside door handle..... 5-15 | 8. Power tailgate button* 5-46 |
| 2. Power window switches5-32 | 9. ESC OFF button 6-31 |
| 3. Power window lock button 5-34 | 10. Steering wheel 5-24 |
| 4. Outside rearview mirror folding switch 5-30 | 11. Ignition switch 6-5 |
| 5. Outside rearview mirror control switch 5-29 | 12. Fuse box 9-52 |
| 6. Central door lock switch 5-15 | 13. Hood release lever 5-41 |
| 7. Headlamp leveling device 5-60 | 14. Seat 3-3 |
- * : if equipped

INSTRUMENT PANEL OVERVIEW

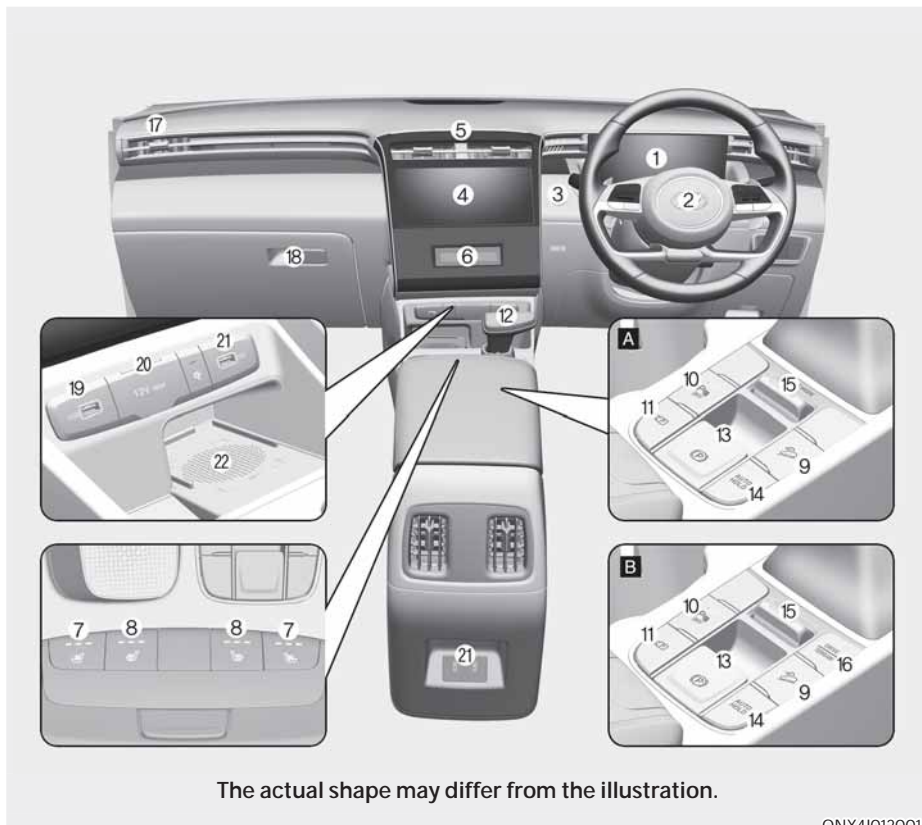

The actual shape may differ from the illustration.

ONX4I012001

- | | | | |
|-------------------------------------|------------|---|------------|
| 1. Instrument cluster | 4-4 | 13. EPB(Electronic Parking Brake)
switch | 6-22 |
| 2. Driver's front air bag..... | 3-45 | 14. Auto Hold switch | 6-26 |
| 3. Engine Start/Stop button..... | 6-9 | 15. Drive mode button* | 6-47, 6-51 |
| 4. Infotainment system | 5-112 | 16. Terrain mode button..... | 6-53 |
| 5. Hazard warning lamp switch | 8-2 | 17. Passenger's front air bag | 3-45 |
| 6. Climate control system | 5-71 | 18. Glove box | 5-100 |
| 7. Air ventilation seat..... | 3-20 | 19. USB port..... | 5-112 |
| 8. Seat warmer..... | 3-18 | 20. Power outlet..... | 5-102 |
| 9. DBC button* | 6-37 | 21. USB charger | 5-103 |
| 10. Parking Safety button..... | 7-102 | 22. Wireless charging system pad..... | 5-104 |
| 11. Parking/View button | 7-78, 7-83 | | |
| 12. Transmission shift lever..... | 6-15 | | |
- * : if equipped

ENGINE COMPARTMENT

■ Smartstream G2.0

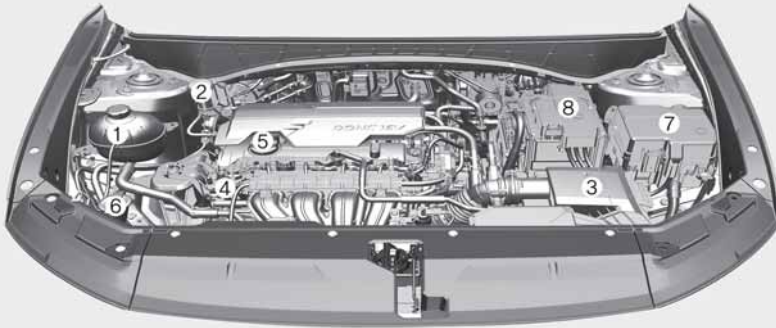

The actual engine compartment in the vehicle may differ from the illustration.

ONX4E090003R

- | | |
|---|---|
| 1. Engine coolant reservoir 9-26 | 6. Windshield washer fluid reservoir 9-30 |
| 2. Brake/clutch* fluid reservoir 9-29 | 7. Fuse box 9-58 |
| 3. Air cleaner 9-31 | 8. Battery 3-58 |
| 4. Engine oil dipstick 9-22 | |
| 5. Engine oil filler cap 9-23 | * : if equipped |

■ Smartstream D2.0



The actual engine compartment in the vehicle may differ from the illustration.

ONX4090002R

- | | | | |
|--|------|--|------|
| 1. Engine coolant reservoir | 9-26 | 6. Windshield washer fluid reservoir | 9-30 |
| 2. Brake/clutch* fluid reservoir | 9-29 | 7. Fuse box | 9-58 |
| 3. Air cleaner | 9-31 | 8. Battery..... | 3-58 |
| 4. Engine oil dipstick | 9-22 | | |
| 5. Engine oil filler cap | 9-23 | * : if equipped | |

DIMENSIONS

Items	mm (in)	
Overall length	4,630 (182.28)	
Overall width	1,865 (73.42)	
Overall height	1,665 (65.55)	
Tread	Front	Rear
	18" : 1,615 (63.58)	18" : 1,622 (63.85)
Wheelbase	2,755 (108.46)	

ENGINE

Engine	Displacement cc (cu. in)	Bore x Stroke mm (in.)	Firing order	No. of cylinders
Smartstream G2.0	1,999 (121.99)	81 X 97 (3.18 X 3.81)	1-3-4-2	4. In-line
Smartstream D2.0	1,998 (121.93)	83 X 92.3 (3.27 X 3.63)	1-3-4-2	4. In-line

BULB WATTAGE

		Light bulb		Bulb type	Wattage
Front	Type A	Headlamp	High	9005HL+	60
			Low	9005HL+	60
		Daytime running lamp (DRL) / position lamp		LED	LED
		Turn signal lamp		PY21W	21
	Type B	Headlamp	High	LED	LED
			Low	LED	LED
			SBL *1	LED	LED
		Daytime running lamp (DRL) / position lamp		LED	LED
		Turn signal lamp		LED	LED
	Turn signal lamp (Outside mirror)		LED	LED	
Rear	Type A	Tail lamp		PY21/5W	21/5
		Tail/Stop lamp		PY21/5W	21/5
	Type B	Tail lamp		LED	LED
		Tail/Stop lamp		LED	LED
	Turn signal lamp		PY21W	21	
	Rear fog lamp		PR21W	21	
	Backup lamp		W5W	5	
	License plate lamp		W5W	5	
			LED	LED	
High mounted stop lamp		LED	LED		
Interior	Map lamp	Type A	W10W	10	
		Type B	LED	LED	
	Interior lamp		FESTOON	10	
	Personnal lamp		LED	LED	
	Glove box lamp		W5W	5	
	Sunvisor lamp		FESTOON	5	
	Luggage compartment lamp		FESTOON	10	

*1: Static Bending Light

TIRES AND WHEELS

Items	Tire size	Wheel size	Inflation pressure kPa (psi)				Wheel nut torque kgf·m (N·m)
			Normal load		Maximum load		
			Front	Rear	Front	Rear	
Full size tire	235/60 R18	7.5J X 18	240 (35)		240 (35)		11-13 (107-127)
Compact spare tire	T135/90 D17	4.0B X 17	420 (60)				

NOTICE

- It is permissible to add 20 kPa (3 psi) to the standard tire pressure specification if colder temperatures are expected soon. Tires typically lose 7 kPa (1 psi) for every 7°C (12°F) temperature drop. If extreme temperature variations are expected, recheck your tire pressure as necessary to keep them properly inflated.
- An air pressure generally decreases, as you drive up to a high-altitude area above sea level. Thus, if you plan to drive a high-altitude area, check the tire pressures in advance. If necessary, inflate them to a proper level (Air inflation per altitude: +10 kPa/1 km (+2.4 psi/1 mile)).
- Must do not exceed maximum inflation pressure shown on equipped tire sidewall.
- Spare wheel is intended for emergency purpose only.
- Only steel wheel is provided as spare wheel. Spare tires can be from any manufacturer.



CAUTION

When replacing tires, ALWAYS use the same size, type, brand, construction and tread pattern supplied with the vehicle. If not, it can damage the related parts or make it work irregularly.

LOAD AND SPEED CAPACITY TIRES

Items	Tire size	Wheel size	Load capacity		Speed capacity	
			LI ^{*1}	kg	SS ^{*2}	km/h
Full size tire	235/65 R17	7.0J X 17	104	900	H	210
	235/60 R18	7.5J X 18	103	875	H	210
	235/55 R19	7.5J X 19	101	825	H	210
Compact spare tire	T135/90 D17	4.0B X 17	104	900	M	130

*1 LI : LOAD INDEX

*2 SS : SPEED SYMBOL

AIR CONDITIONING SYSTEM

Items	Weight of volume		Classification
Refrigerant g (oz.)	Front	550 (19.40) ± 25 (0.88)	R-134a
Compressor lubricant g (oz.)	Front	120 (4.23) ± 10 (0.35)	PAG

We recommend you to contact an authorized HYUNDAI dealer for more details.

GROSS VEHICLE WEIGHT

Items			Gross vehicle weight [kg (lbs.)]
Smartstream D2.0	2WD	AT	2,100 (4,629)
	4WD	AT	2,210 (4,872)
Smartstream G2.0	2WD	AT	1,980 (4,365)

LUGGAGE VOLUME

ℓ (cu. ft.)

Items		Gasoline		Diesel
		Full size spare tire	Compact spare tire	Compact spare tire
				For Euro 6D
VDA	MIN	539 (19)	582 (20.5)	540 (19)
	MAX	1,860 (65.7)	1,903 (67.2)	1,861 (65.7)

Min : Behind rear seat to upper edge of the seat back.

Max : Behind front seat to roof.

RECOMMENDED LUBRICANTS AND CAPACITIES

To help achieve proper engine and powertrain performance and durability, use only lubricants of the proper quality. The correct lubricants also help promote engine efficiency that results in improved fuel economy.

These lubricants and fluids are recommended for use in your vehicle.

Lubricant				Volume	Classification
Engine oil *1 *2 (drain and refill) Recommends	Gasoline Engine	Smartstream G2.0		4.3 ℓ (4.54 US qt.)	SAE 0W-20, API SN PLUS/SP
	Diesel Engine	Smartstream D2.0	With DPF	5.6 ℓ (5.92 US qt.)	ACEA C5, C2 or C3
Without DPF			ACEA A3 or B4		
Automatic transmission fluid	Gasoline Engine	Smartstream G2.0		6.7 ℓ (7.08 US qt.)	ATF SP4M-1, HYUNDAI genuine ATF SP4M-1
	Diesel Engine	Smartstream D2.0	2WD	7.1 ℓ (7.40 US qt.)	
4WD					

*1: Refer to the recommended SAE viscosity numbers.

*2: Requires <API SN PLUS (or Above) Full synthetic> grade engine oil. If a lower grade engine oil (mineral oil including Semi-synthetic) is used, then the engine oil and engine oil filter must be replaced as indicated severe maintenance condition

Lubricant		Volume	Classification
Brake fluid		As required	DOT-4 Only
Rear differential oil (4WD)		0.53 ~ 0.63 ℓ (0.56 ~ 0.67 US qt.)	HYPOID GEAR OIL API GL-5, SAE 75W/85 (SK HCT-5 GEAR OIL 75W/85 or EQUIVALENT)
Transfer case oil (4WD)	A/T	0.62 ~ 0.68 ℓ (0.65 ~ 0.71 US qt.)	HYPOID GEAR OIL API GL-5, SAE 75W/85 (SK HCT-5 GEAR OIL 75W/85 or Transfer case oil (4WD) EQUIVALENT)
Urea solution (Diesel Engine)		14 ℓ (14.79 US qt.)	ISO22241, DIN70070
Coolant	Smartstream G2.0	A/T	6.76 ℓ (7.14 US qt.)
	Smartstream D2.0	A/T	8.93 ℓ (9.43 US qt.)
			MIXTURE, Antifreeze with water (Ethylene glycol base coolant for aluminum radiator)

A/T : Automatic transmission

Recommended SAE viscosity number



CAUTION

Always be sure to clean the area around any filler plug, drain plug, or dipstick before checking or draining any lubricant. This is especially important in dusty or sandy areas and when the vehicle is used on unpaved roads. Cleaning the plug and dipstick areas will prevent dirt and grit from entering the engine and other mechanisms that could be damaged.

Engine oil viscosity (thickness) has an effect on fuel economy and cold weather operating (engine start and engine oil flowability). Lower viscosity engine oils can provide better fuel economy and cold weather performance, however, higher viscosity engine oils are required for satisfactory lubrication in hot weather. Using oils of any viscosity other than those recommended could result in engine damage.

When choosing an oil, consider the range of temperature your vehicle will be operated in before the next oil change. Proceed to select the recommended oil viscosity from the chart.

		Temperature Range for SAE Viscosity Numbers									
Temperature	°C	-30	-20	-10	0	10	20	30	40	50	
	(°F)	-10	0	20	40	60	80	100	120		
Smartstream G2.0 *1		0W-20									
Smartstream D2.0		10W-30/40									
		5W-30/40									
		0W-30									
		0W-20									
		0W-20									

*1: If mineral oil or semi-synthetic oil is used, it is a severe maintenance condition in terms of engine oil change.



An engine oil displaying this API Certification Mark conforms to the international Lubricant Specification Advisory Committee (ILSAC). It is recommended to only use engine oils that uphold this API Certification Mark.

VEHICLE IDENTIFICATION NUMBER (VIN)

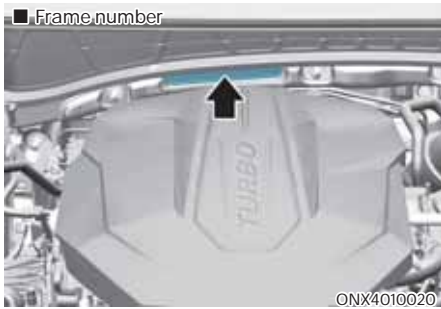

The vehicle identification number (VIN) is the number used in registering your vehicle and in all legal matters pertaining to its ownership, etc.

The number is punched on the engine compartment frame and back side of the engine.



The VIN is also on a plate attached to the top of the dashboard. The number on the plate can easily be seen through the windshield from outside.

VEHICLE CERTIFICATION LABEL



The vehicle certification label attached on the driver's (or front passenger's) side center pillar gives the vehicle identification number (VIN).

TIRE SPECIFICATION AND PRESSURE LABEL



The tires supplied on your new vehicle are chosen to provide the best performance for normal driving.

The tire label located on the driver's side center pillar gives the tire pressures recommended for your vehicle.

ENGINE NUMBER

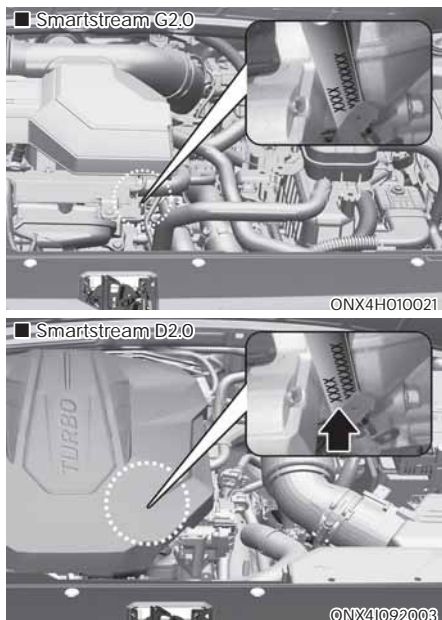

The engine number is stamped on the engine block as shown in the drawing.

AIR CONDITIONER COMPRESSOR LABEL



A compressor label informs you the type of compressor your vehicle is equipped with such as model, supplier part number, production number, refrigerant (1) and refrigerant oil (2).

DECLARATION OF CONFORMITY (IF EQUIPPED)

■ Example

CE CE 0678

CE0678

The radio frequency components of the vehicle comply with requirements and other relevant provisions of Directive 1995/5/EC.

Further information including the manufacturer's declaration of conformity is available on HYUNDAI web site as follows;

<http://service.hyundai-motor.com>

FUEL LABEL (IF EQUIPPED)

Gasoline engine

The fuel label is attached on the fuel filler door.

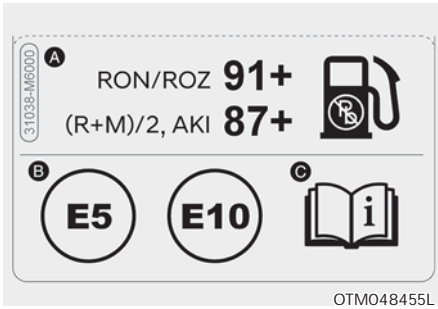

- A. Octane rating of unleaded gasoline
 1. RON/ROZ : Research Octane Number
 2. (R+M)/2, AKI : Anti Knock Index
- B. Identifiers for Petrol-type fuels
 - * This symbol means usable fuel. Do not use any other fuel.
- C. For further details, refer to the “Fuel Requirement” section in the Chapter 1.

Diesel engine

The fuel label is attached on the fuel filler door.

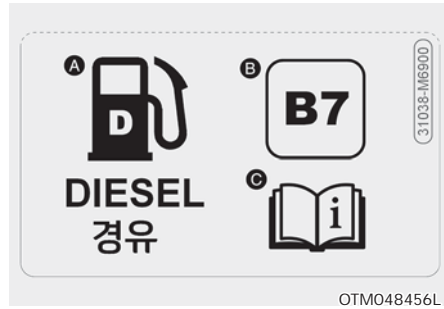

- A. Fuel : Diesel
- B. Identifiers for FAME containing Diesel-type fuels
 - * This symbol means usable fuel. Do not use any other fuel.
- C. For further details, refer to the “Fuel Requirement” section in Chapter 1.

3. Safety System

Important safety precautions	3-2
Always wear your seat belt	3-2
Restrain all children.....	3-2
Air bag hazards.....	3-2
Driver distraction.....	3-2
Control your speed.....	3-2
Keep your vehicle in safe condition	3-2
Seats	3-3
Safety precautions	3-4
Front seats	3-5
Rear seats	3-10
Headrest.....	3-14
Seat warmers.....	3-18
Air ventilation seat.....	3-20
Seat belts.....	3-22
Seat belt safety precautions.....	3-22
Seat belt warning light.....	3-23
Seat belt restraint system	3-26
Additional seat belt safety precautions	3-30
Care of seat belts.....	3-32
Child Restraint System (CRS)	3-33
Our recommendation: Children always in the rear	3-33
Selecting a Child Restraint System (CRS).....	3-34
Installing a Child Restraint System (CRS)	3-36
Air bag - supplemental restraint system	3-43
Where are the air bags?	3-45
How does the air bags system operate?.....	3-48
What to expect after an air bag inflates	3-51
Do not install a Child Restraint System on the front passenger seat	3-52
Why didn't my air bag go off in a collision?.....	3-52
SRS care.....	3-58
Additional safety precautions.....	3-59
Air bag warning labels.....	3-59

IMPORTANT SAFETY PRECAUTIONS

You will find many safety precautions and recommendations throughout this section, and throughout this manual. The safety precautions in this section are among the most important.

Always wear your seat belt

A seat belt is your best protection in all types of accidents. Air bags are designed to supplement seat belts, not replace them. So even though your vehicle is equipped with air bags, ALWAYS make sure you and your passengers wear your seat belts, and wear them properly.

Restrain all children

All children under age 13 should ride in your vehicle properly restrained in a rear seat, not the front seat. Infants and small children should be restrained in an appropriate Child Restraint System. Larger children should use a booster seat with the lap/shoulder belt until they can use the seat belt properly without a booster seat.

Air bag hazards

While air bags can save lives, they can also cause serious or fatal injuries to occupants who sit too close to them, or who are not properly restrained. Infants, young children, and short adults are at the greatest risk of being injured by an inflating air bag. Follow all instructions and warnings in this manual.

Driver distraction

Driver distraction presents a serious and potentially deadly danger, especially for inexperienced drivers. Safety should be the first concern when behind the wheel and drivers need to be aware of the wide array of potential distractions, such as drowsiness, reaching for objects, eating, personal grooming, other passengers, and using mobile phones.

Drivers can become distracted when they take their eyes and attention off the road or their hands off the wheel to focus on activities other than driving. To reduce your risk of distraction and an accident:

- ALWAYS set up your mobile devices (for example, MP3 players, phones, navigation units, etc.) when your vehicle is parked or safely stopped.
- ONLY use your mobile device when allowed by laws and conditions permit safe use. NEVER text or email while driving. Most countries have laws prohibiting drivers from texting. Some countries and cities also prohibit drivers from using handheld phones.
- NEVER let the use of a mobile device distract you from driving. You have a responsibility to your passengers and others on the road to always drive safely, with your hands on the wheel as well as your eyes and attention on the road.

Control your speed

Excessive speed is a major factor in crash injuries and deaths. Generally, the higher the speed, the greater the risk, but serious injuries can also occur at lower speeds. Never drive faster than is safe for current conditions, regardless of the maximum speed posted.

Keep your vehicle in safe condition

Having a tire blowout or a mechanical failure can be extremely hazardous. To reduce the possibility of such problems, check your tire pressures and condition frequently, and perform all regularly scheduled maintenance.

SEATS

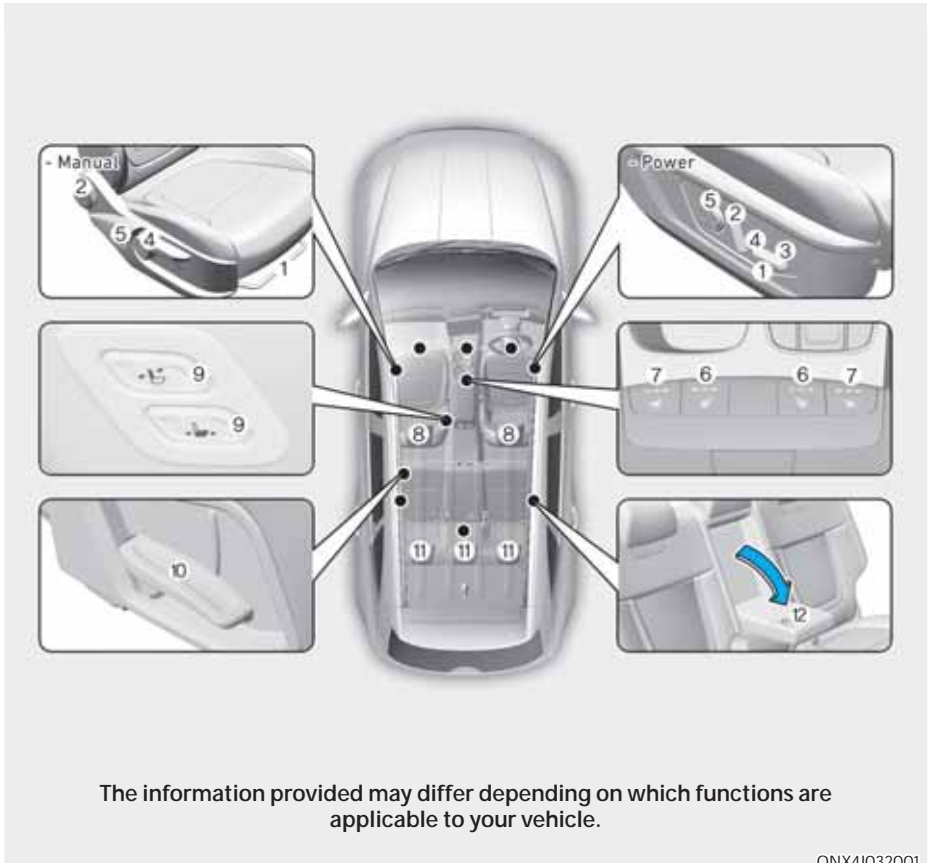
**Front seats**

- (1) Forward and rearward
- (2) Seatback angle
- (3) Seat cushion angle*
- (4) Seat height
- (5) Lumbar support (Driver's seat)*
- (6) Seat warmer*
- (7) Air ventilation seat*
- (8) Headrest
- (9) Walk-in switch *

Rear seats

- (10) Seatback angle and folding
- (11) Headrest
- (12) Armrest

* : if equipped

Safety precautions

Adjusting the seats so that you are sitting in a safe and comfortable position plays an important role for the safety of the driver and passengers, along with seat belts and air bags when in an accident.



WARNING

Do not use a cushion that reduces friction between the seat and the passenger. The passenger's hips may slide under the lap portion of the seat belt during an accident or a sudden stop.

Serious or fatal internal injuries could result because the seat belt cannot operate properly.

Air bags

You can take steps to reduce the risk of being injured by an inflating air bag. Sitting too close to an air bag greatly increases the risk of injury in the event the air bag inflates. Move your seat as far back as possible from front air bags, while still maintaining control of the vehicle.



WARNING

To reduce the risk of serious injury or death from an inflating air bag, take the following precautions:

- Adjust the driver's seat as far to the rear as possible maintaining the ability to control the vehicle.
- Adjust the front passenger seat as far to the rear as possible.
- Hold the steering wheel by the rim with hands at the 9 o'clock and 3 o'clock positions to minimize the risk of injuries to your hands and arms.
- NEVER place anything or anyone between you and the air bag.
- Do not allow the front passenger to place feet or legs on the dashboard to minimize the risk of leg injuries.

Seat belts

Always fasten your seat belt before starting any trip. At all times, passengers should sit upright and be properly restrained. Infants and small children must be restrained in appropriate Child Restraint Systems. Children who have outgrown a booster seat and adults must be restrained using the seat belts.



WARNING

Take the following precautions when adjusting your seat belt:

- NEVER use one seat belt for more than one occupant.
- Always position the seatback upright with the lap portion of the seat belt snug and low across the hips.
- NEVER allow children or small infants to ride on a passenger's lap.
- Do not route the seat belt across your neck, across sharp edges, or reroute the shoulder strap away from your body.
- Do not allow the seat belt to become caught or jammed.

Front seats

The front seat can be adjusted by using the control switches located on the outside of the seat cushion. Before driving, adjust the seat to the proper position so that you can easily control the steering wheel, foot pedals and controls on the instrument panel.



WARNING

Take the following precautions when adjusting your seat:

- NEVER attempt to adjust the seat while the vehicle is moving. The seat could respond with unexpected movement and may cause loss of vehicle control resulting in an accident.
- Do not place anything under the front seats. Loose objects in the driver's foot area could interfere with the operation of the foot pedals, causing an accident.
- Do not allow anything to interfere with the normal position and proper locking of the seatback.
- Do not place a cigarette lighter on the floor or seat. When you operate the seat, gas may exit out of the lighter causing a fire.

- Use extreme caution when picking up small objects trapped under the seats or between the seat and the center console. Your hands might be cut or injured by the sharp edges of the seat mechanism.
- If there are occupants in the rear seats, be careful while adjusting the front seat position.
- Make sure that the seat is locked in place after the adjustment. If not, the seat might move unexpectedly resulting in an accident.



CAUTION

To prevent injury:

- Do not adjust your seat while wearing your seat belt. Moving the seat cushion forward may cause strong pressure on your abdomen.
- Do not allow your hands or fingers to get caught in the seat mechanisms while the seat is moving.

Manual adjustment



Forward and rearward adjustment

To move the seat forward or rearward:

1. Pull up the seat slide adjustment lever and hold it.
2. Slide the seat to the position you desire.
3. Release the lever and make sure the seat is locked in place. Move forward and rearward without using the lever. If the seat moves, it is not locked properly.

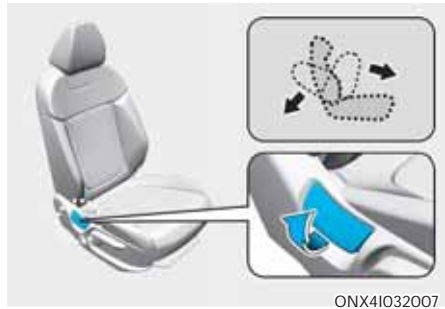

Seatback angle

To recline the seatback:

1. Lean forward slightly and lift up the seatback lever.
2. Carefully lean back on the seat and adjust the seatback to the position you desire.
3. Release the knob and make sure the seatback is locked in place.

Reclining seatback

Sitting in a reclined position when the vehicle is in motion can be dangerous. Even when buckled up, the protections of your restraint system (seat belts and/or air bags) is greatly reduced by reclining your seatback.



WARNING

NEVER ride with a reclined seatback when the vehicle is moving.

Riding with a reclined seatback increases your chance of serious or fatal injuries in the event of a collision or sudden stop.

Drivers and passengers should **ALWAYS** sit well back in their seats with the seatbacks upright and should be belted properly.

Seat belts must be snug against your hips and chest to work properly. When the seatback is reclined, the shoulder belt cannot do its job because it will not be snug against your chest. Instead, it will be in front of you. During an accident, you could be thrown into the seat belt, causing neck or other injuries.

The more the seatback is reclined, the greater chance the passenger's hips will slide under the lap belt or the passenger's neck will strike the shoulder belt.

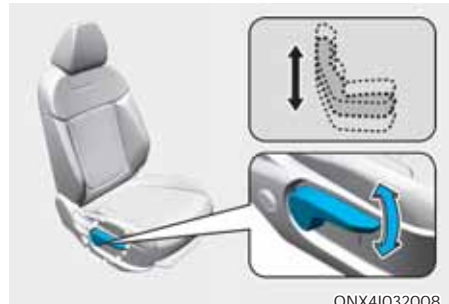

ONX41032008

Seat height

To change the height of the seat:

- Push down the lever several times, to lower the seat.
- Pull up the lever several times, to raise the seat.



ONX41032009

Lumbar support (for driver's seat, if equipped)

- The lumbar support can be adjusted by pressing the lumbar support switch.
- Press the front portion of the switch (1) to increase support or the rear portion of the switch (2) to decrease support.

Power adjustment (if equipped)

⚠ WARNING

NEVER allow children in the vehicle unattended. The power seats are operable when the vehicle is turned off.

NOTICE

To prevent damage to the seats:

- Always stop adjusting the seats when the seat has been adjusted as far forward or rearward as possible.
- Do not adjust the seats longer than necessary when the vehicle is turned off. This may result in unnecessary battery drain.
- Do not operate two or more seats at the same time. This may result in an electrical malfunction.

Forward and rearward adjustment



To move the seat forward or rearward:

1. Push the control switch forward or rearward.
2. Release the switch once the seat reaches the desired position.

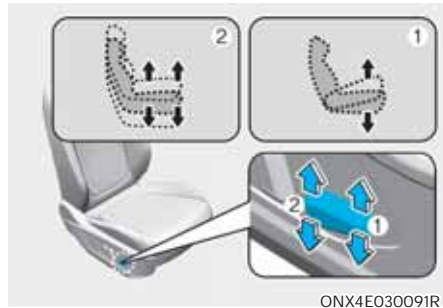

Seat cushion tilt (1, if equipped)

To change the angle of the front part of the seat cushion:

Push the front portion of the control switch up to raise or down to lower the front part of the seat cushion.

Release the switch once the seat reaches the desired position.

Seat height (2)

To change the height of the seat:

Push the rear portion of the control switch up to raise or down to lower the height of the seat.

Release the switch once the seat reaches the desired position.

Seatback angle adjustment



To recline the seatback:

1. Push the control switch forward or rearward.
2. Release the switch once the seatback reaches the desired position.

Reclining seatback

Sitting in a reclined position when the vehicle is in motion can be dangerous. Even when buckled up, the protections of your restraint system (seat belts and air bags) is greatly reduced by reclining your seatback.



WARNING

NEVER ride with a reclined seatback when the vehicle is moving.

Riding with a reclined seatback increases your chance of serious or fatal injuries in the event of a collision or sudden stop.

Driver and passengers should ALWAYS sit well back in their seats with the seatbacks upright and should be belted properly.

Seat belts must be snug against your hips and chest to work properly. When the seatback is reclined, the shoulder belt cannot do its job because it will not be snug against your chest. Instead, it will be in front of you. During an accident, you could be thrown into the seat belt, causing neck or other injuries.

The more the seatback is reclined, the greater chance the passenger's hips will slide under the lap belt or the passenger's neck will strike the shoulder belt.

Lumbar support (for driver's seat, if equipped)



To adjust the lumbar support:

1. Press the front portion of the switch (1) to increase support or the rear portion of the switch (2) to decrease support.
2. Release the switch once the lumbar support reaches the desired position.

Walk-in switch (if equipped)



The rear seat passenger may use the switches to control the front passenger seat.

- Sliding forward or rearward:
Press the switch (1) or (2) to move the front passenger seat forward or rearward.
- Seatback angle:
Press the switch (3) or (4) to recline the front passenger seatback forward or rearward.

Seatback pocket

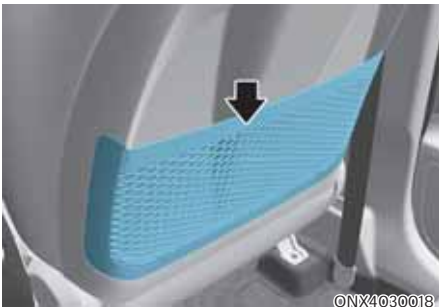

The seatback pocket is provided on the back of the front seatbacks.

CAUTION

Do not put heavy or sharp objects in the seatback pockets. In an accident they could come loose from the pocket and injure occupants.

Rear seats

Folding the rear seat

The rear seatbacks can be folded to facilitate carrying long items or to increase the luggage capacity of the vehicle.

WARNING

- Never allow passengers to sit on top of the folded down seatback while the vehicle is moving. This is not a proper seating position and no seat belts are available for use. This could result in serious injury or death in case of an accident or sudden stop.
- Objects carried on the folded down seatback should not extend higher than the top of the front seatbacks. This could allow cargo to slide forward and cause injury or damage during sudden stops.

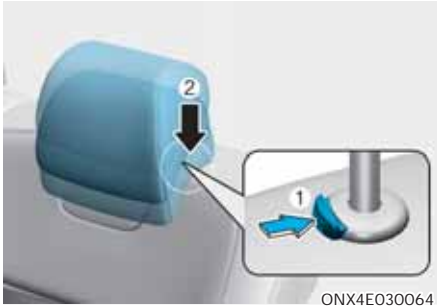

To fold down the rear seatback:

1. Set the front seatback to the upright position and if necessary, slide the front seat forward.
2. Lower the rear headrests to the lowest position by pushing and holding the release button (1) and pushing down on the headrest (2).



3. Locate the seatbelt toward the outboard position before folding down the seatback. If not, the seatbelt system may be interfered by the seatback.

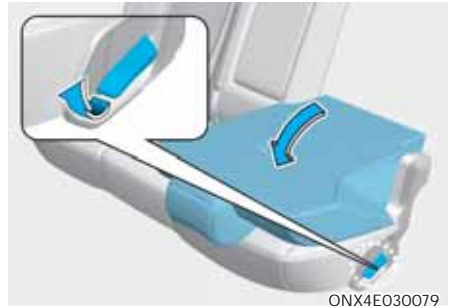

4. Pull up the seatback folding lever (1), then fold the seat toward the front of the vehicle.

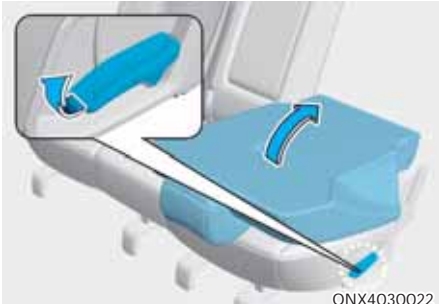

5. To use the rear seat, lift and push the seatback rearward by lifting up the front portion of the folding lever.
Push the seatback firmly until it clicks into place. Make sure the seatback is locked in place.

 **WARNING**

When returning the rear seatback from a folded to an upright position, hold the seatback and return it slowly. Ensure that the seatback is completely locked into its upright position by pushing on the top of the seatback. In an accident or sudden stop, the unlocked seatback could allow cargo to move forward with great force and enter the passenger compartment, which could result in serious injury or death.

 **WARNING**

Do not place objects in the rear seats, since they cannot be properly secured and may hit vehicle occupants in a collision causing serious injury or death.

 **WARNING**

When returning the rear seatback from a folded to an upright position, hold the seatback and return it slowly. Ensure that the seatback is completely locked into its upright position by pushing on the top of the seatback. In an accident or sudden stop, the unlocked seatback could allow cargo to move forward with great force and enter the passenger compartment, which could result in serious injury or death.

WARNING

Make sure the engine is off, the Automatic transmission is in N (Neutral) and the parking brake is securely applied whenever loading or unloading cargo. Failure to take these steps may allow the vehicle to move if the gear is inadvertently shifted to another position.

CAUTION

- Be careful when loading cargo through the rear passenger seats to prevent damage to the vehicle interior.
- When cargo is loaded through the rear passenger seats, ensure the cargo is properly secured to prevent it from moving while driving.

WARNING

Cargo should always be secured to prevent it from being thrown about the vehicle in a collision and causing injury to the vehicle occupants. Do not place objects in the rear seats, since they cannot be properly secured and may hit the front seat occupants in a collision.

Seatback remote folding/unfolding (if equipped)



Pull the rear seatback folding switch (1) located on both sides of the cargo area.

WARNING

Rear seat folding

Do not fold the rear seats, if passengers, pets or luggage are in the rear seats.

It may cause injury or damage to passengers, pets, luggage.

Armrest



The armrest is located in the center of the rear seat. Pull the armrest down from the seatback to use it.

Rear occupant alert system (rear seats) (if equipped)

This function alerts driver when getting out of a vehicle that passengers remain in the rear seats.

If you open the door with passengers in the rear seats, the warning message appear on the cluster panel to give a first warning. If the movement is detected in the rear seats after you lock all doors, 2nd warning alerts you.

Make sure you check the passenger in the rear seats before you get off.

For more information, refer to the “Rear occupant alert system” in chapter 3.

Headrest

The vehicle’s front and rear seats have adjustable headrests. The headrests provide comfort for passengers, but more importantly they are designed to help protect passengers from whiplash and other neck and spinal injuries during an accident, especially in a rear impact collision.

WARNING

To help reduce the risk of serious injury or death in an accident, take the following precautions when adjusting your headrests:

- Always properly adjust the headrests for all passengers BEFORE starting the vehicle.
- NEVER let anyone ride in a seat with the headrest removed or reversed.

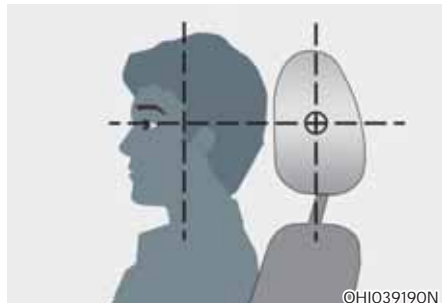

- Adjust the headrests so the middle of the headrest is at the same height as the height of the top of the eyes.
- NEVER adjust the headrest position of the driver’s seat when the vehicle is in motion.
- Adjust the headrest as close to the passenger’s head as possible. Do not use a seat cushion that holds the body away from the seatback.
- Make sure the headrest locks into position after adjusting it.

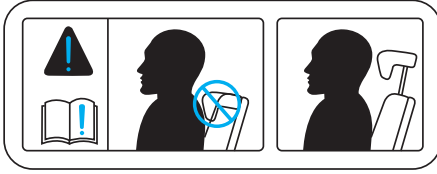
WARNING

OTL035061

When sitting on the rear seat, do not adjust the height of the headrest to the lowest position.

CAUTION

When there is no occupant in the rear seats, adjust the height of the headrest to the lowest position. The rear seat headrest can reduce the visibility of the rear area.

NOTICE

To prevent damage, NEVER hit or pull on the headrests.

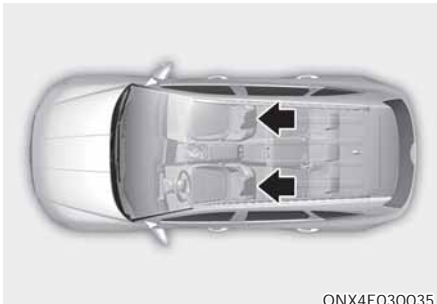
Front seat headrests

ONX4E030035

The driver's and front passenger's seats are equipped with adjustable headrests for safety and comfort.

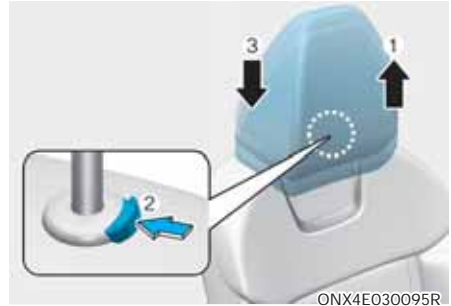

ONX4E030095R

Adjusting the height up and down

To raise the headrest:

1. Pull it up to the desired position (1).

To lower the headrest:

1. Push and hold the release button (2) on the headrest support.
2. Lower the headrest to the desired position (3).

NOTICE

OH1038136

If you recline the seatback towards the front with the headrest and seat cushion raised, the headrest may come in contact with the sunvisor or other parts of the vehicle.

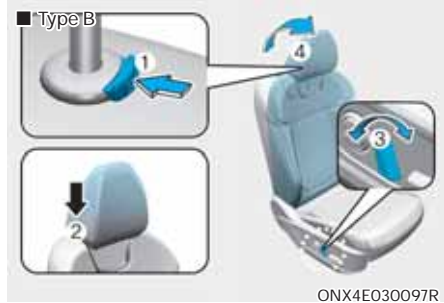
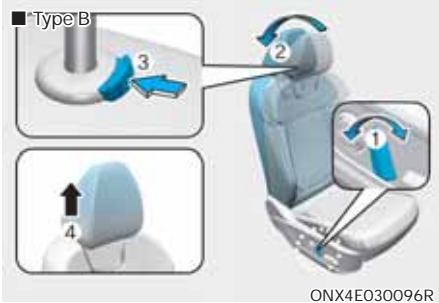
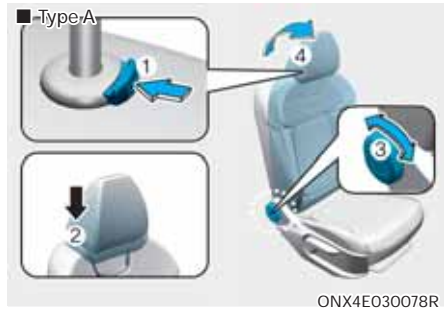
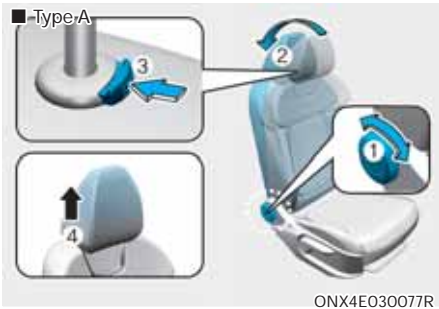

Removal/Reinstall

To remove the headrest:

1. Recline the seatback (2) with using the seatback angle knob or switch (1).
2. Raise the headrest as far as it can go.
3. Press the headrest release button (3) while pulling the headrest up (4).

⚠ WARNING

NEVER allow anyone to travel in a seat with the headrest removed.

To reinstall the headrest :

1. Recline the seatback.
2. Put the headrest poles (2) into the holes while pressing the release button (1).
3. Adjust the headrest to the appropriate height.
4. Recline the seatback (4) with the seatback angle knob or switch (3).

⚠ WARNING

Always make sure the headrest locks into position after reinstalling and adjusting it properly.

Rear seat headrests

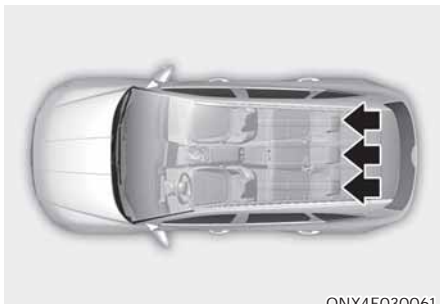

ONX4E030061

The rear seats are equipped with headrests in all the seating positions for the passenger's safety and comfort.



ONX4030020

Adjusting the height up and down

To raise the headrest:

1. Pull it up to the desired position (1).

To lower the headrest:

1. Push and hold the release button (2) on the headrest support.
2. Lower the headrest to the desired position (3).

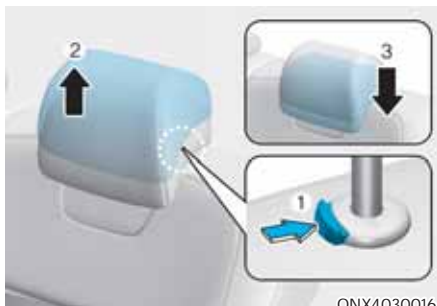

ONX4030016

Removal/Reinstallation

To remove the headrest:

1. Raise the headrest as far as it can go.
2. Press the headrest release button (1) while pulling the headrest up (2).

To reinstall the headrest:

1. Put the headrest poles into the holes (3) while pressing the release button (1).
2. Adjust the headrest to the appropriate height.

Seat warmers (if equipped)

Seat warmers are provided to warm the seats during cold weather.

During mild weather or under conditions where the operation of the seat warmer is not needed, keep the seat warmers OFF.



WARNING

The seat warmers can cause a **SERIOUS BURN**, even at low temperatures and especially if used for long periods of time.

Passengers must be able to feel if the seat is becoming too warm so they can turn it off, if needed.

People who cannot detect temperature change or pain to the skin should use extreme caution, especially the following types of passengers:

- Infants, children, elderly or disabled persons, or hospital outpatients.
- People with sensitive skin or who burn easily.
- Fatigued individuals.
- Intoxicated individuals.
- People taking medication that can cause drowsiness or sleepiness.



WARNING

NEVER place anything on the seat that insulates against heat when the seat warmer is in operation, such as a blanket or seat cushion. This may cause the seat warmer to overheat, causing a burn or damage to the seat.

NOTICE

To prevent damage to the seat warmers and seats:

- Never use a solvent such as paint thinner, benzene, alcohol or gasoline to clean the seats.
- Do not place heavy or sharp objects on seats equipped with seat warmers.
- Do not change the seat cover. It may damage the seat warmer.

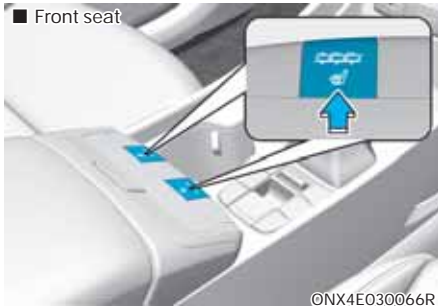

While the engine is running, push either of the switches to warm the driver's seat or front passenger's seat.

During mild weather or under conditions where the operation of the seat warmer is not needed, keep the switches in the OFF position.

- Manual temperature control

Each time you push the switch, the temperature setting of the seat is changed as follows:

- Front seat

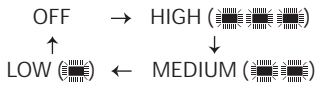

- Automatic temperature control

The seat warmer starts to automatically control the seat temperature in order to prevent low-temperature burns after being manually turned ON.

- Front seat

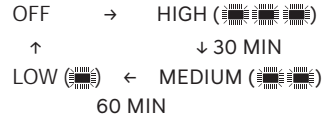

If HIGH temperature is manually selected again, the temperature will be controlled automatically.

- When pressing the switch for more than 1.5 seconds with the seat warmer operating, the seat warmer will turn OFF.
- The seat warmer defaults to the OFF position whenever the ignition switch or Engine Start/Stop button is ON.
- Auto Comfort Control (for driver's seat) (if equipped)
 - The seat warmer automatically controls the seat temperature depending on the ambient temperature and the set climate control temperature when the engine is running. If the seat warmer switch is pushed, the seat warmer will have to be controlled manually.
To use this function, it must be activated from the Settings menu in the infotainment system screen.
 - The seat warmer defaults to the OFF position whenever the ignition switch or Engine Start/Stop button is ON. However, if the Auto Comfort Control function is ON, the driver's seat warmer will turn on and off depending on the ambient temperature and the set climate control temperature.

For more details, refer to the infotainment manual supplied separately with your vehicle.

i Information

With the seat warmer switch in the ON position, the heating system in the seat turns off or on automatically depending on the seat temperature.

Air ventilation seat (if equipped)



The air ventilation seats are provided to cool the front seats by blowing air through small vent holes on the surface of the seat cushions and seatbacks.

When the operation of the air ventilation seat is not needed, keep the switches in the OFF position.

While the engine is running, push the switch to cool the driver's seat or the front passenger's seat (if equipped).

SEAT BELTS

This section describes how to use the seat belts properly. It also describes some of the things not to do when using seat belts.

Seat belt safety precautions

Always fasten your seat belt and make sure all passengers have fastened their seat belts before starting any trip. Air bags are designed to supplement the seat belt as an additional safety device, but they are not a substitute. Most countries require all occupants of a vehicle to wear seat belts.



WARNING

Seat belts must be used by **ALL** passengers whenever the vehicle is moving. Take the following precautions when adjusting and wearing seat belts:

- Children under the age of 13 should be properly restrained in the rear seats.
- Never allow children to ride in the front passenger seat, unless the air bag is deactivated. If a child is seated in the front passenger seat, move the seat as far back as possible. And the child must always be restrained in the seat properly.
- NEVER allow an infant or child to be carried on an occupant's lap.
- NEVER ride with the seatback reclined when the vehicle is moving.
- Do not allow children to share a seat or seat belt.
- Do not wear the shoulder belt under your arm or behind your back.

- Never wear a seat belt over fragile objects. If there is a sudden stop or impact, the seat belt can damage it.
- Do not use the seat belt if it is twisted. A twisted seat belt will not protect you properly in an accident.
- Do not use a seat belt if the webbing or hardware is damaged.
- Do not latch the seat belt into the buckles of other seats.
- NEVER unfasten the seat belt while driving. This may cause loss of vehicle control resulting in an accident.
- Make sure there is nothing in the buckle interfering with the seat belt latch mechanism, because any materials in the buckle can cause the seat belt not to be fastened securely.
- No modifications or additions should be made by the user which will either prevent the seat belt adjusting devices from operating to remove slack, or prevent the seat belt assembly from being adjusted to remove slack.



WARNING

Damaged seat belts and seat belt assemblies will not operate properly. Always replace:

- Frayed, contaminated, or damaged webbing.
- Damaged hardware.
- The entire seat belt assembly after it has been worn in an accident, even if damage to webbing or assembly is not apparent.

Seat belt warning light

Driver's seat belt warning

■ Instrument cluster



As a reminder to the driver, the driver's seat belt warning light will illuminate for approximately 6 seconds each time you turn the ignition switch or Engine Start/Stop button ON regardless of seat belt fastening.

If you start to drive without the seat belt fastened or you unfasten the seat belt when you drive under 20km/h (12 mph) or stop, the corresponding warning light will illuminate.

If you start to drive without the seat belt fastened or you unfasten the seat belt when you drive 20km/h (12 mph) and faster, the warning light will blink and warning chime will sound for approximately 100 seconds.

When the seat belt is unfastened during driving, the warning light will illuminate when the speed is under 20 km/h (12 mph).

When the speed is 20 km/h (12 mph) and faster, the warning light will blink and warning chime will sound for approximately 100 seconds.

Front passenger's seat belt warning

As a reminder to the front passenger, the front passenger's seat belt warning lights will illuminate for approximately 6 seconds each time you turn the ignition switch or Engine Start/Stop button ON regardless of belt fastening.

If you start to drive without the seat belt fastened or you unfasten the seat belt when you drive under 20km/h (12 mph) or stop, the corresponding warning light will illuminate.

If you start to drive without the seat belt fastened or you unfasten the seat belt when you drive 20km/h (12 mph) and faster, the warning light will blink and warning chime will sound for approximately 100 seconds.

When the seat belt is fastened during driving, the warning light will illuminate when the speed is under 20 km/h (12 mph). When the speed is 20 km/h (12 mph) and faster, the warning light will blink and warning chime will sound for approximately 100 seconds.



WARNING

Riding in an improper position adversely affects the front passenger's seat belt warning system. It is important for the driver to instruct the passenger to be seated properly as instructed in this manual.



Information

- **Although the front passenger seat is not occupied, the seat belt warning light will blink or illuminate for 6 seconds.**
- **The front passenger's seat belt warning may operate when luggage is placed on the front passenger seat.**

If you continue to drive without the seat belt fastened or you unfasten the seat belt when you drive 20km/h (12 mph) and faster, the seat belt warning chime will sound for approximately 35 seconds and the corresponding warning light will blink.

When the seat belt is unfastened during driving, the warning light will illuminate when the speed is under 20 km/h (12 mph).

When the speed is 20 km/h (12 mph) and faster, the warning light will blink and warning chime will sound for approximately 35 seconds.



WARNING

Riding in an improper position adversely affects the rear passenger's seat belt warning system.

It is important for the driver to instruct the passenger to properly be seated as instructed in this manual.



Information

- **Although the rear side passenger seat is not occupied, the seat belt warning light will blink or illuminate for 6 seconds.**
- **The rear side passenger's seat belt warning may operate when luggage, laptop or other electronic device is placed on the rear side passenger seat.**

Rear passenger's seat belt warning



For rear left and right side seat

As a reminder to the rear passenger, the rear passenger's seat belt warning lights will illuminate for approximately 6 seconds each time you turn the ignition switch or Engine Start/Stop button ON regardless of belt fastening.

If you start to drive without the seat belt fastened or you unfasten the seat belt when you drive under 20 km/h (12 mph), the corresponding warning light will continue to illuminate until you fasten the seat belt.

If you continue to drive without the seat belt fastened or you unfasten the seat belt when you drive 20 km/h (12 mph) and faster, the seat belt warning chime will sound for approximately 35 seconds and the corresponding warning light will blink.

When the seat belt is unfastened during driving, the warning light will illuminate when the speed is under 20 km/h (12 mph).

When the speed is 20 km/h (12 mph) and faster, the warning light will blink and warning chime will sound for approximately 35 seconds.



WARNING

Riding in an improper position adversely affects the rear passenger's seat belt warning system.

It is important for the driver to instruct the passenger to properly be seated as instructed in this manual.



Information

- **Although the rear side passenger seat is not occupied, the seat belt warning light will blink or illuminate for 6 seconds.**
- **The rear side passenger's seat belt warning may operate when luggage, laptop or other electronic device is placed on the rear side passenger seat.**

For rear center seat

As a reminder to the rear passenger, the rear passenger's seat belt warning light will illuminate for approximately 6 seconds each time you turn the ignition switch or Engine Start/Stop button ON regardless of belt fastening.

If the seat belt is not fastened when the ignition switch or Engine Start/Stop button is turned ON, the seat belt warning light will illuminate for approximately 70 seconds.

If you start to drive without the seat belt fastened or you unfasten the seat belt when you drive under 20km/h (12 mph), the corresponding warning light will continue to illuminate for approximately 70 seconds.

If you continue to drive without the seat belt fastened or you unfasten the seat belt when you drive over 20km/h (12 mph), the seat belt warning chime will sound for approximately 35 seconds and the corresponding warning light will blink.

If the rear door is opened or closed under 10 km/h, warning light and warning sound does not work even if driving over 20 km/h (12 mph).

Seat belt restraint system

Lap/shoulder belt



To fasten your seat belt:

Pull it out of the retractor and insert the metal tab (1) into the buckle (2). There will be an audible “click” when the tab locks into the buckle.



You should place the lap belt (1) portion across your hips and the shoulder belt (2) portion across your chest.

The seat belt automatically adjusts to the proper length after the lap belt portion is adjusted manually so that it fits snugly around your hips. If you lean forward in a slow, easy motion, the belt will extend and move with you.

If there is a sudden stop or impact, the belt will lock into position. It will also lock if you try to lean forward too quickly.

NOTICE

If you are not able to smoothly pull enough of the seat belt out from the retractor, firmly pull the seat belt out and release it. After release, you will be able to pull the belt out smoothly.

⚠ WARNING



Improperly positioned seat belts may increase the risk of serious injury in an accident. Take the following precautions when adjusting the seat belt:

- Position the lap portion of the seat belt as low as possible across your hips, not on your waist, so that it fits snugly. This allows your strong pelvic bones to absorb the force of the crash, reducing the chance of internal injuries.
- Position one arm under the shoulder belt and the other over the belt, as shown in the illustration.
- Always position the shoulder belt anchor into the locked position at the appropriate height.
- Never position the shoulder belt across your neck or face.

Height adjustment

You can adjust the height of the shoulder belt anchor to one of the four different positions for maximum comfort and safety.

The shoulder portion should be adjusted so it lies across your chest and midway over your shoulder nearest the door, not over your neck.

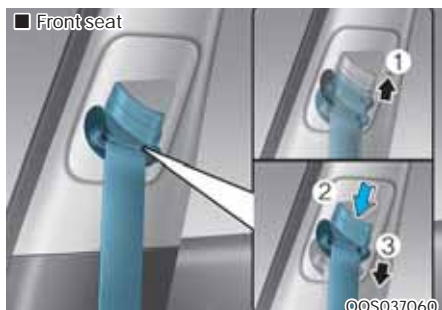

To adjust the height of the seat belt anchor, lower or raise the height adjuster into an appropriate position.

To raise the height adjuster, pull it up (1). To lower it, push it down (3) while pressing the height adjuster button (2).

Release the button to lock the anchor into position. Try sliding the height adjuster to make sure that it has locked into position.



To release your seat belt:

Press the release button (1) in the locking buckle.

When it is released, the belt should automatically draw back into the retractor. If this does not happen, check the belt to be sure it is not twisted, then try again.

Rear center seatbelt (3-point rear center seat belt)



To fasten your seatbelt:

Insert the tongue plate (1) into the buckle (2) until an audible “click” is heard, indicating the latch is locked. Make sure the belt is not twisted.

When using the rear center seat belt, the buckle with the “CENTER” mark must be used.

i Information

If you are not able to pull out the safety belt from the retractor, firmly pull the belt out and release it. After release, you will be able to pull the belt out smoothly.

! WARNING

Make sure that the seatback is locked in place when using the rear center seat belt.

If not, the seatback may move when there is a sudden stop or collision, which could result in serious injury.

Stowing the rear seat belt

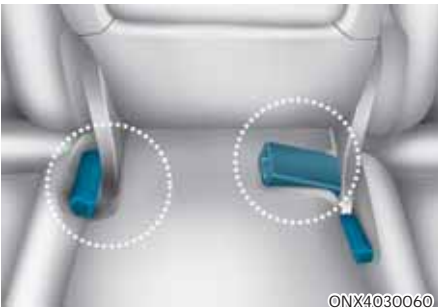

The rear seat belt buckles can be stowed in the pocket between the rear seatback and cushion when not in use.

Pre-tensioner seat belt



[1] : Retractor pre-tensioner seat belt
Front seat and rear seat (if equipped)

Your vehicle is equipped with driver's and front passenger's Pre-tensioner Seat Belts (Retractor Pre-tensioner). The purpose of the pre-tensioner is to make sure the seat belts fit tightly against the occupant's body in certain frontal or side collision(s). The pre-tensioner seat belts may be activated in crashes where the frontal or side collision(s) is severe enough, together with the air bags.

When the vehicle stops suddenly, or if the occupant tries to lean forward too quickly, the seat belt retractor will lock into position.

In certain frontal collisions, the pre-tensioner will activate and pull the seat belt into tighter contact against the occupant's body.

If the system senses excessive tension on the driver or passenger's seat belt when the pre-tensioner system activates, the load limiter inside the retractor pre-tensioner will release some of the pressure on the affected seat belt (if equipped with load limiter).

WARNING

- Always wear your seat belt and sit properly in your seat.
- Do not use the seat belt if it is loose or twisted. A loose or twisted seat belt will not protect you properly in an accident.
- Do not place anything near the buckle. This may adversely affect the buckle and cause it to function improperly.
- Always replace your pre-tensioners after activation or an accident.
- NEVER inspect, service, repair or replace the pre-tensioners by yourself. We recommend that you have the pre-tensioners inspected, serviced, repaired or replaced by an authorized HYUNDAI dealer.
- Do not hit the seat belt assemblies.

WARNING

Do not touch the pre-tensioner seat belt assemblies for several minutes after they have been activated. When the pre-tensioner seat belt mechanism deploys during a collision, the pre-tensioner can become hot and can burn you.

CAUTION

Body work on the front area of the vehicle may damage the pre-tensioner seat belt system. Therefore, we recommend the system to be serviced by an authorized HYUNDAI dealer.

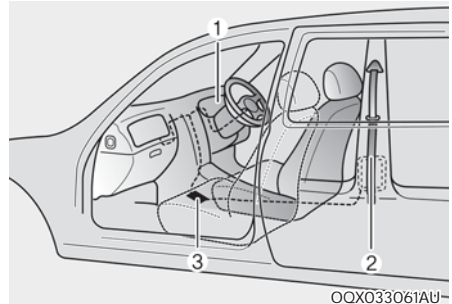

The Pre-Tensioner Seat Belt System consists mainly of the following components. Their locations are shown in the illustration above:

- (1) SRS air bag warning light
- (2) Retractor pre-tensioner
- (3) SRS control module

NOTICE

The sensor that activates the SRS control module is connected with the pre-tensioner seat belts. The SRS air bag warning light on the instrument cluster will illuminate for approximately 3–6 seconds after the Engine Start/Stop button is in the ON position, and then it should turn off.

If the pre-tensioner is not working properly, the warning light will illuminate even if the SRS air bag is not malfunctioning. If the warning light does not illuminate, stays illuminated or illuminates when the vehicle is being driven, we recommend the pre-tensioner seat belts and/or SRS control module be inspected by an authorized HYUNDAI dealer as soon as possible.



Information

- Pre-tensioner seat belts may be activated in certain frontal or side collisions or rollover situations (if equipped with rollover sensor).
- When the pre-tensioner seat belts are activated, a loud noise may be heard and fine dust, which may appear to be smoke, may be visible in the passenger compartment. These are normal operating conditions and are not hazardous.
- Although it is non-toxic, the fine dust may cause skin irritation and should not be inhaled for prolonged periods. Wash all exposed skin areas thoroughly after an accident in which the pre-tensioner seat belts were activated.

Additional seat belt safety precautions

Seat belt use during pregnancy

The seat belt should always be used during pregnancy. The best way to protect your unborn child is to protect yourself by always wearing the seat belt.

Pregnant women should always wear a lap-shoulder seat belt. Place the shoulder belt across your chest, routed between your breasts and away from your neck. Place the lap belt below your belly so that it fits SNUGLY across your hips and pelvic bone, under the rounded part of the belly.



WARNING

- Pregnant women are more vulnerable to any impacts on the abdomen during an abrupt stop or accident. If you are in an accident while pregnant, consult your doctor.
- To reduce the risk of serious injury or death to an unborn child during an accident, pregnant women should NEVER place the lap portion of the seat belt above or over the area of the abdomen where the unborn child is located.

Seat belt use and children

Infant and small children

Most countries have Child Restraint System laws which require children to travel in approved Child Restraint System devices, including booster seats. The age at which seat belts can be used instead of Child Restraint System differs among countries, so you should be aware of the specific requirements in your country, and where you are travelling. Infant and Child Restraint System must be properly placed and installed in a rear seat.

For more information refer to the “Child Restraint Systems” section in this chapter.

 **WARNING**

ALWAYS properly restrain infants and small children in a Child Restraint System appropriate for the child's height and weight.

To reduce the risk of serious injury or death to a child and other passengers, **NEVER** hold a child in your lap or arms when the vehicle is moving. The violent forces created during an accident will tear the child from your arms and throw the child against the interior of the vehicle.

Small children are best protected from injury in an accident when properly restrained in the rear seat by a Child Restraint System that meets the requirements of the Safety Standards of your country. Before buying any Child Restraint System, make sure that it has a label certifying that it meets Safety Standard of your country.

The Child Restraint System must be appropriate for your child's height and weight. Check the label on the Child Restraint System for this information. Refer to "Child Restraint Systems" section in this chapter.

Larger children

Children under age 13 and who are too large for a booster seat should always occupy the rear seat and use the available lap/shoulder belts. A seat belt should lie across the upper thighs and be snug across the shoulder and chest to restrain the child safely. Check belt fit periodically. A child's squirming could put the belt out of position. In the event of an accident, children are afforded the best safety restrained by a proper Child Restraint System in the rear seats.

If a larger child over age 13 must be seated in the front seat, the child must be securely restrained by the available lap/shoulder belt and the seat should be placed in the rearmost position.

If the shoulder belt portion slightly touches the child's neck or face, try placing the child closer to the center of the vehicle. If the shoulder belt still touches their face or neck, they need to be returned to an appropriate booster seat in the rear seat.

 **WARNING**

- **Always** make sure larger children's seat belts are worn and properly adjusted.
- **NEVER** allow the shoulder belt to contact the child's neck or face.
- **Do not** allow more than one child to use a single seat belt.

Seat belt use and injured people

A seat belt should be used when an injured person is being transported. Consult a physician for specific recommendations.

One person per belt

Two people (including children) should never attempt to use a single seat belt. This could increase the severity of injuries in case of an accident.

Do not lie down

Sitting in a reclined position when the vehicle is in motion can be dangerous. Even when buckled up, the protections of your restraint system (seat belts and/or air bags) is greatly reduced by reclining your seatback.

Seat belts must be snug against your hips and chest to work properly.

During an accident, you could be thrown into the seat belt, causing neck or other injuries.

The more the seat back is reclined, the greater the chance for the passenger's hips to slide under the lap belt or the passenger's neck to strike the shoulder belt.



WARNING

- **NEVER ride with a reclined seatback when the vehicle is moving.**
- **Riding with a reclined seatback increases your chance of serious or fatal injuries in the event of a collision or sudden stop.**
- **Driver and passengers should always sit well back in their seats, with the seatbacks upright and should be belted properly.**

Care of seat belts

Seat belt systems should never be disassembled or modified. In addition, care should be taken to assure that seat belts and belt hardware are not damaged by seat hinges, doors or other abuse.

Periodic inspection

All seat belts should be inspected periodically for wear or damage of any kind. Any damaged parts should be replaced as soon as possible.

Keep belts clean and dry

Seat belts should be kept clean and dry. If belts become dirty, they can be cleaned by using a mild soap solution and warm water. Bleach, dye, strong detergents or abrasives should not be used because they may damage and weaken the fabric.

When to replace seat belts

The entire seat belt assembly or assemblies should be replaced if the vehicle has been involved in an accident. This should be done even if no damage is visible. We recommend that you consult an authorized HYUNDAI dealer.

CHILD RESTRAINT SYSTEM (CRS)

Our recommendation: Children always in the rear



WARNING

Always properly restrain children in the vehicle. Children of all ages are safer when riding in the rear seats. Never place a rearward-facing Child Restraint System on the front passenger seat, unless the air bag is deactivated.

Children under age 13 should always ride in the rear seats and must always be properly restrained to minimize the risk of injury in an accident, sudden stop or sudden maneuver.

According to accident statistics, children are safer when properly restrained in the rear seats than in the front seat. Children too large for a Child Restraint System must use the seat belts provided.

Most countries have regulations which require children to travel in approved Child Restraint Systems.

The laws governing the age or height/weight restrictions at which seat belts can be used instead of Child Restraint System differs among countries, so you should be aware of the specific requirements in your country, and where you are travelling.

Child Restraint Systems must be properly installed in the vehicle seat. Always use a commercially available Child Restraint System that meets the requirements of your country.

Child Restraint System (CRS)

Infants and younger children must be restrained in an appropriate rearward-facing or forward-facing CRS that has first been properly secured to the seat of the vehicle. Read and comply with the instructions for installation and use provided by the manufacturer of the Child Restraint System.



WARNING

- **Always follow the Child Restraint System manufacturer's instructions for installation and use.**
- **Always properly restrain your child in the Child Restraint System.**
- **Do not use an infant carrier or a child safety seat that "hooks" over a seatback, it may not provide adequate protection in an accident.**
- **After an accident, we recommend a HYUNDAI dealer to check the Child Restraint System, seat belts, ISOFIX anchorages and top-tether anchorages.**

Selecting a Child Restraint System (CRS)

When selecting a Child Restraint System for your child, always:

- Make sure the Child Restraint System has a label certifying that it meets applicable Safety Standards of your country.

A Child Restraint System may only be installed if it was approved in accordance with the requirements of ECE-R44 or ECE-R129.

- Select a Child Restraint System based on your child's height and weight. The required label or the instructions for use typically provide this information.
- Select a Child Restraint System that fits the vehicle seating position where it will be used.
- Read and comply with the warnings and instructions for installation and use provided with the Child Restraint System.

Child Restraint System types

There are three main types of Child Restraint Systems: rearward-facing, forward-facing and booster Child Restraint Systems.

They are classified according to the child's age, height and weight.



Rearward-facing Child Restraint System

A rearward-facing Child Restraint System provides restraint with the seating surface against the back of the child. The harness system holds the child in place, and in an accident, acts to keep the child positioned in the Child Restraint Systems and reduce the stress to the fragile neck and spinal cord.

All children under the age of one year must always ride in a rearward-facing Child Restraint System. There are different types of rearward-facing Child Restraint Systems: infant-only Child Restraint Systems can only be used rearward-facing. Convertible and 3-in-1 Child Restraint Systems typically have higher height and weight limits for the rearward-facing position, allowing you to keep your child rearward-facing for a longer period of time.

Keep using Child Restraint Systems in the rearward-facing position as long as children fit within the height and weight limits allowed by the Child Restraint System's manufacturer.



Forward-facing Child Restraint System

A forward-facing Child Restraint System provides restraint for the child's body with a harness. Keep children in a forward-facing Child Restraint System with a harness until they reach the top height or weight limit allowed by your Child Restraint System's manufacturer.

Once your child outgrows the forward-facing Child Restraint System, your child is ready for a booster seat.

Booster seats

A booster seat is a Child Restraint System designed to improve the fit of the vehicle's seat belt system. A booster seat positions the seat belt so that it fits properly over the stronger parts of your child's body. Keep your children in booster seats until they are big enough to fit in a seat belt properly.

For a seat belt to fit properly, the lap belt must lie comfortable across the upper thighs, not the stomach. The shoulder belt should lie comfortable across the shoulder and chest and not across the neck or face. Children under age 13 must always be properly restrained to minimize the risk of injury in an accident, sudden stop or sudden maneuver.

Installing a Child Restraint System (CRS)



WARNING

Before installing your Child Restraint System always:

- Read and follow the instructions provided by the manufacturer of the Child Restraint System.
- Read and follow the instructions regarding child restraint systems in this manual.

Failure to follow all warnings and instructions could increase the risk of the **SERIOUS INJURY** or **DEATH** if an accident occurs.



WARNING

If the vehicle headrest prevents proper installation of a Child Restraint System, the headrest of the respective seating position shall be readjusted or entirely removed.

After selecting a proper Child Restraint System for your child and checking that the Child Restraint System fits properly on the seating position, there are three general steps for a proper installation:

- **Properly secure the Child Restraint System to the vehicle.** All Child Restraint Systems must be secured to the vehicle with the lap belt or lap part of a lap/shoulder belt or with the ISOFIX top-tether and/or ISOFIX anchorage and/or with the support leg.

- **Make sure the Child Restraint System is firmly secured.** After installing a Child Restraint System to the vehicle, push and pull the seat forward and from side-to-side to verify that it is securely attached to the seat. A Child Restraint System secured with a seat belt should be installed as firmly as possible. However, some side-to-side movement can be expected.

When installing a Child Restraint System, adjust the vehicle seat and seatback (up and down, forward and rearward) so that your child fits in the Child Restraint System in a comfortable manner.

- **Secure the child in the Child Restraint System.** Make sure the child is properly strapped in the Child Restraint System according to the Child Restraint System manufacturer's instructions.



CAUTION

A Child Restraint System in a closed vehicle can become very hot. To prevent burns, check the seating surface and buckles before placing your child in the Child Restraint System.

Child Seat Restraint Suitability for Seat Position using the Seat Belt

Suitability of each seating position for "universal" category belted Child Restraint Systems according to ECE regulations.

Use Child Restraint Systems that have been officially approved and are appropriate for your children.

When using the Child Restraint Systems, refer to the following table.

Mass Group		Seating position (or other side)				
		Front Passenger	Rear Outboard	Rear Center	Intermediate Outboard	Intermediate Center
Group 0	up to 10kg	X	U	X	-	-
Group 0 +	up to 13kg	X	U	X	-	-
Group I	9 to 18kg	X	U	X	-	-
Group II	15 to 25kg	X	U	X	-	-
Group III	22 to 36kg	X	U	X	-	-

U = Suitable for "universal" category Child Restraint Systems approved for use in this mass group.

UF = Suitable for forward facing "universal" category restraints approved for use in this mass group.

L = Suitable for particular child restraints given on attached list. These restraints may be of the "specific vehicle", "restricted" or "semi-universal" categories.

B = Built-in restraint approved for this mass group.

X = Seat position not suitable for children in this mass group.

Child Seat Restraint for Vehicle ISOFIX Positions

Suitability of each seating position for ISOFIX Child Restraint Systems according to ECE regulations.

Mass Group	Size Class	Fixture	Vehicle ISOFIX positions			
			1st	2nd row		
			Passenger	Left Hand	Center	Right Hand
Carrycot	F	ISO/L1	N/A	X	N/A	X
	G	ISO/L2	N/A	X	N/A	X
0- : UP TO 10KG	E	ISO/R1	N/A	IL	N/A	IL
0+ : UP TO 13KG	E	ISO/R1	N/A	IL	N/A	IL
	D	ISO/R2	N/A	IL	N/A	IL
	C	ISO/R3	N/A	IL	N/A	IL
1 : 9 TO 18KG	D	ISO/R2	N/A	IL	N/A	IL
	C	ISO/R3	N/A	IL	N/A	IL
	B	ISO/F2	N/A	IUF, IL	N/A	IUF, IL
	B1	ISO/F2X	N/A	IUF, IL	N/A	IUF, IL
	A	ISO/F3	N/A	IUF, IL	N/A	IUF, IL

IUF = Suitable for ISOFIX forward child restraints systems of universal category approved for use in the mass group.

IL = Suitable for particular ISOFIX child restraints systems (CRS) approved for this vehicle type according to ECE44. These ISOFIX CRS are those of the "specific vehicle", "restricted" or "semi-universal" categories.

X = ISOFIX position not suitable for ISOFIX child restraint system in this mass group and/or this size class.

A - ISO/F3: Full-Height Forward-Facing toddler CRS (height 720mm)

B - ISO/F2: Reduced-Height Forward-Facing toddler CRS (height 650mm)

B1 - ISO/F2X: Reduced-Height Second Version Back Surface Shape Forward-Facing toddler CRS (height 650mm)

C - ISO/R3: Full-Size Rearward-Facing toddler CRS

D - ISO/R2: Reduced-Size Rearward-Facing toddler CRS

E - ISO/R1: Infant-Size Rearward-Facing CRS

F - ISO/L1: Left Lateral Facing position CRS (carry-cot)

G - ISO/L2: Right Lateral Facing position CRS (carry-cot)

ISOFIX anchorage and top-tether anchorage (ISOFIX anchorage system) for children

The ISOFIX system holds a Child Restraint System during driving and in an accident. This system is designed to make installation of the Child Restraint System easier and reduce the possibility of improperly installing your Child Restraint System. The ISOFIX system uses anchors in the vehicle and attachments on the Child Restraint System. The ISOFIX system eliminates the need to use seat belts to secure the Child Restraint System to the rear seats. ISOFIX anchorages are metal bars built into the vehicle. There are two lower anchors for each ISOFIX seating position that will accommodate a Child Restraint System with lower attachments.

To use the ISOFIX system in your vehicle, you must have a Child Restraint System with ISOFIX attachments.

The Child Restraint System manufacturer will provide you with instructions on how to use the Child Restraint System with its attachments for the ISOFIX anchorages.

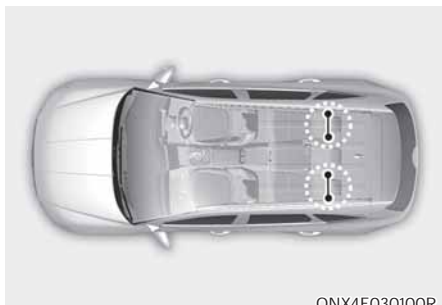



ISOFIX anchorages have been provided in the left and right outboard rear seating positions. Their locations are shown in the illustration.

⚠ WARNING

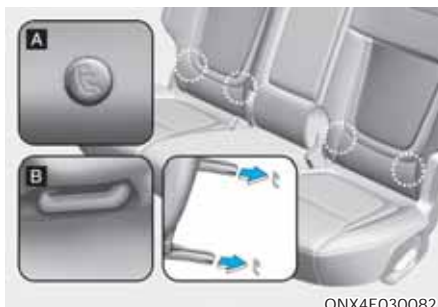
Do not attempt to install a Child Restraint System using ISOFIX anchorages in the rear center seating position. There are no ISOFIX anchorages provided for this seat. Using the outboard seat anchorages, for the CRS installation on the rear center seating position, can damage the anchorages.



[A] : ISOFIX Anchorage Position Indicator
(Type A- , Type B- )

[B] : ISOFIX Anchorage

ISOFIX anchorages are located between the seatback and the seat cushion of the rear seat left and right outboard seating positions, indicated by the symbols.

In addition, ISOFIX anchorages are located between the seatback and the seat cushion of the front passenger seat outboard seating positions. (if equipped)

Securing a Child Restraint System with the “ISOFIX Anchorage System”

To install an i-Size or ISOFIX-compatible Child Restraint System in either of the rear outboard seating positions and the front passenger outboard seating positions (if equipped):

1. Move the seat belt buckle away from the ISOFIX anchorages.
2. Move any other objects away from the anchorages that could prevent a secure connection between the Child Restraint System and the ISOFIX anchorages.
3. Place the Child Restraint System on the vehicle seat, then attach the seat to the ISOFIX anchorages according to the instructions provided by the Child Restraint System manufacturer.
4. Follow the instructions of the Child Restraint System’s manufacturer for proper installation and connection of the ISOFIX attachments on the Child Restraint System to the ISOFIX anchorages.



WARNING

Take the following precautions when using the ISOFIX system:

- Read and follow all installation instructions provided with your Child Restraint System.
- To prevent the child from reaching and taking hold of unretracted seat belts, buckle all unused rear seat belts and retract the seat belt webbing behind the child. Children can be strangled if a shoulder belt becomes wrapped around their neck and the seat belt tightens.
- NEVER attach more than one Child Restraint System to a single anchorage. This could cause the anchor or attachment to come loose or break.
- Following an accident, we recommend to have the ISOFIX system inspected by your HYUNDAI dealer. An accident can damage the ISOFIX system and may not properly secure the Child Restraint System.

Securing a Child Restraint System seat with "Top-tether Anchorage" system



Top-tether anchorages for Child Restraint Systems are located on the rear of the seatbacks.



1. Route the Child Restraint System top-tether strap over the seatback. Placing the top tether strap, please follow the instructions of the Child Restraint System manufacturer.
2. Connect the top-tether strap to the top-tether anchorage, then tighten the top-tether strap according to the instructions of your Child Restraint System's manufacturer to firmly attach the Child Restraint System to the seat.

WARNING

Take the following precautions when installing the top-tether:

- Read and follow all installation instructions provided with your Child Restraint System.
- NEVER attach more than one Child Restraint System to a single ISOFIX top-tether anchorage. This could cause the anchorage or attachment to come loose or break.
- Do not attach the top-tether to anything other than the correct top-tether anchorage. It may not work properly if attached to something else.
- Child Restraint System anchorages are designed to withstand only those loads imposed by correctly fitted Child Restraint System.
Do not use them for adult seat belts, harnesses, or for attaching other items or equipment to the vehicle.

Securing a Child Restraint System with a lap/shoulder belt

When not using the ISOFIX system, all Child Restraint Systems must be secured to a rear seat with the lap part of a lap/shoulder belt.

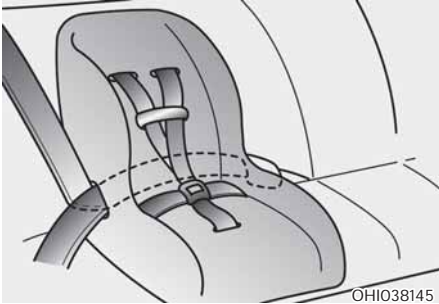

Installing a Child Restraint System with a lap/shoulder belt

To install a Child Restraint System on the rear seats, do the following:

1. Place the Child Restraint System on a rear seat and route the lap/shoulder belt around or through the Child Restraint System, following the Child Restraint System manufacturer's instructions. Make sure the seat belt webbing is not twisted.

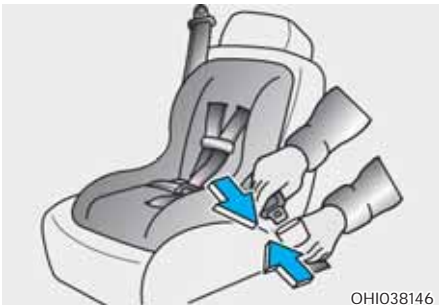

2. Fasten the lap/shoulder belt latch into the buckle. Listen for the distinct "click" sound.

i Information

Position the release button so that it is easy to access in case of an emergency.

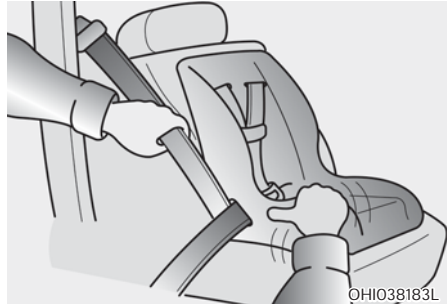

3. Remove as much slack from the belt as possible by pushing down on the Child Restraint System while feeding the shoulder belt back into the retractor.
4. Push and pull on the Child Restraint System to confirm that the seat belt is holding it firmly in place.

If your Child Restraint System manufacturer recommends the use of a top-tether with the lap/shoulder belt, see page 3-41.

To remove the Child Restraint System, press the release button on the buckle and then pull the lap/shoulder belt out of the Child Restraint System and allow the seat belt to retract fully.

AIR BAG - SUPPLEMENTAL RESTRAINT SYSTEM

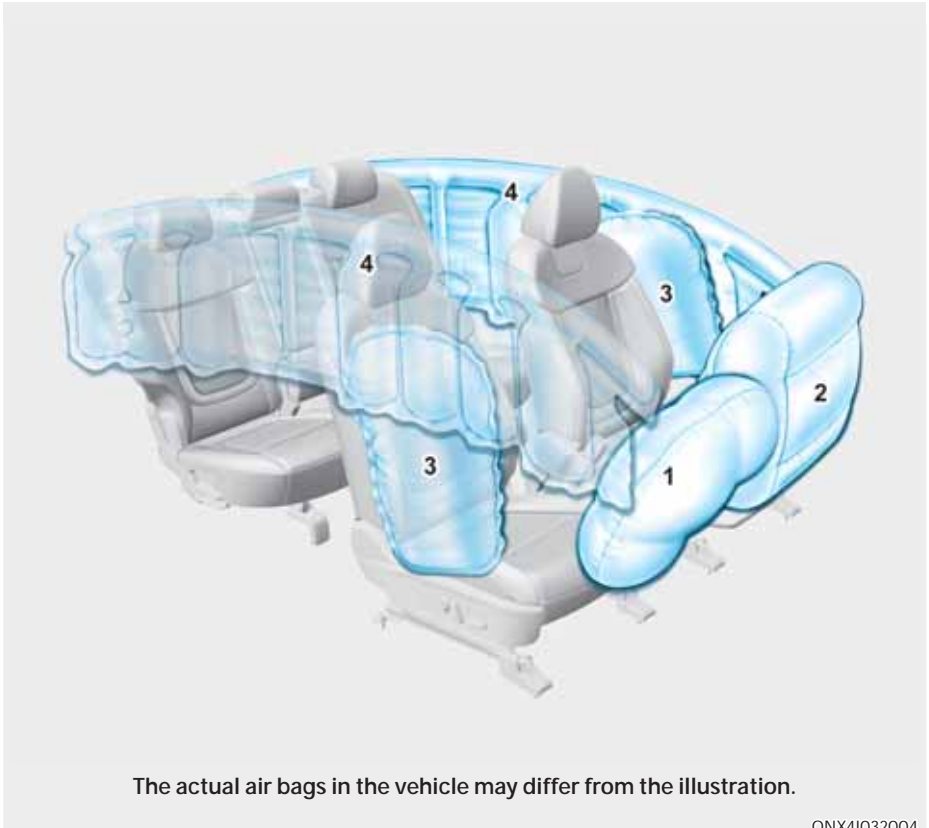

1. Driver's front air bag
2. Passenger's front air bag

3. Side air bag *
4. Curtain air bag *

* : if equipped

This vehicle is equipped with a Supplemental Air Bag System for the driver's seat and front passenger's seats.

The front air bags are designed to supplement the three-point seat belts. For these air bags to provide protection, the seat belts must be worn at all times when driving.

You can be severely injured or killed in an accident if you are not wearing a seat belt. Air bags are designed to supplement seat belts, but do not replace them. Also, air bags are not designed to deploy in every collision. In some accidents, the seat belts are the only restraint protecting you.



WARNING

AIR BAG SAFETY PRECAUTIONS

ALWAYS use seat belts and Child Restraint Systems - every trip, every time, everyone! Even with air bags, you can be seriously injured or killed in a collision if you are improperly belted or not wearing your seat belt when the air bag inflates.

NEVER place a child in any Child Restraint System or booster seat in the front passenger seat, unless the air bag is deactivated.

An inflating air bag could forcefully strike the infant or child causing serious or fatal injuries.

ABC - Always Buckle Children under age 13 in the back seat. It is the safest place for children of any age to ride. If a child age 13 or older must be seated in the front seat, he or she must be properly belted and the seat should be moved as far back as possible.

All occupants should sit upright with the seatback in an upright position, centered on the seat cushion with their seat belt on, legs comfortably extended and their feet on the floor until the vehicle is parked and the vehicle is turned off. If an occupant is out of position during an accident, the rapidly deploying air bag may forcefully contact the occupant causing serious or fatal injuries.

You and your passengers should never sit or lean unnecessarily close to the air bags or lean against the door or center console.

Move your seat as far back as possible from front air bags, while still maintaining control of the vehicle.

Where are the air bags?

Driver's and passenger's front air bags



Your vehicle is equipped with a Supplemental Restraint System (SRS) and lap/shoulder belts at both the driver and passenger seating positions.

The SRS consists of air bags which are located in the center of the steering wheel and the passenger's side front panel pad above the glove box.

The air bags are labeled with the letters "AIR BAG" embossed on the pad covers.

The purpose of the SRS is to provide the vehicle's driver and front passengers with additional protection than that offered by the seat belt system alone in case of a frontal impact of sufficient severity.

WARNING

To reduce the risk of serious injury or death from inflating front air bags, take the following precautions:

- Seat belts must be worn at all times to help keep occupants positioned properly.
- Move your seat as far back as possible from front air bags, while still maintaining control of the vehicle.
- Never lean against the door or center console.
- Do not allow the front passenger to place their feet or legs on the dashboard.
- No objects (such as crash pad cover, mobile phone holder, cup holder, air fresheners or stickers) should be placed over or near the air bag modules on the steering wheel, instrument panel, windshield glass, and the front passenger's panel above the glove box. Such objects could cause harm if the vehicle is in a crash severe enough to cause the air bags to deploy.
- Do not attach any objects on the front windshield and inside mirror.

Side air bags (if equipped)

■ Side air bag



Your vehicle is equipped with a side air bag in each front row seat. The purpose of the air bag is to provide the vehicle's additional protection than that offered by the seat belt alone.

The side air bags are designed to deploy during certain side impact collisions, depending on the crash severity.

For vehicles equipped with a rollover sensor the side and/or curtain air bags and pre-tensioners on both sides of the vehicle may deploy if a rollover or possible rollover is detected.

The side air bags are not designed to deploy in all side impact or rollover situations.

WARNING

To reduce the risk of serious injury or death from an inflating side air bag take the following precautions:

- Seat belts must be worn at all times to help keep occupants positioned properly.
- Do not allow passengers to lean their heads or bodies onto doors, put their arms on the doors, stretch their arms out of the window, or place objects between the doors and seats.
- Hold the steering wheel at the 9 o'clock and 3 o'clock positions, to minimize the risk of injuries to your hands and arms.
- Do not use any accessory seat covers. This could reduce or prevent the effectiveness of the system.
- Do not hang other objects except clothes. In an accident it may cause vehicle damage or personal injury especially when air bag is inflated.
- Do not place any objects over the air bag or between the air bag and yourself. Also, do not attach any objects around the area the air bag inflates such as the door, side door glass, front and rear pillar.
- Do not place any objects between the door and the seat. They may become dangerous projectiles if the side air bag inflates.
- Do not install any accessories on the side or near the side air bags.
- Do not cause impact to the doors when the ignition switch or Engine Start/Stop button is in the ON or START position as this may cause the side air bags to inflate.
- If the seat or seat cover is damaged, we recommend that the system serviced by an authorized HYUNDAI dealer.

Curtain air bags (if equipped)



Curtain air bags are located along both sides of the roof rails above the front and rear doors.

They are designed to help protect the heads of the front seat occupants and the rear outboard seat occupants in certain side impact collisions.

The curtain air bags are designed to deploy during certain side impact collisions, depending on the crash severity.

For vehicles equipped with a rollover sensor the side and/or curtain air bags and pre-tensioners on both sides of the vehicle may deploy if a rollover or possible rollover is detected.

The curtain air bags are not designed to deploy in all side impact or rollover situations.

WARNING

To reduce the risk of serious injury or death from an inflating curtain air bag, take the following precautions:

- All seat occupants must wear seat belts at all times to help keep occupants positioned properly.
- Properly secure Child Restraint System as far away from the door as possible.
- Do not place any objects over the air bag. Also, do not attach any objects around the area the air bag inflates such as the door, side door glass, front and rear pillar, roof side rail.
- Do not hang other objects except clothes, especially hard or breakable objects.

In an accident, it may cause vehicle damage or personal injury.

- Do not allow passengers to lean their heads or bodies onto doors, put their arms on the doors, stretch their arms out of the window, or place objects between the doors and seats.
- Do not open or repair the side curtain air bags.

How does the air bags system operate?

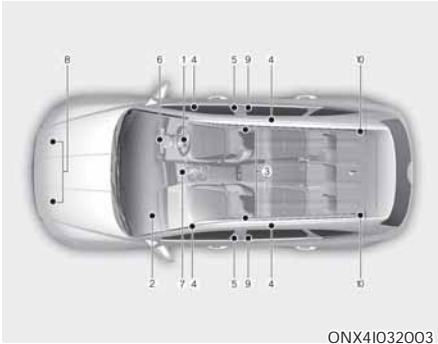

- (1) Driver's front air bag module
- (2) Passenger's front air bag module
- (3) Side air bag modules
- (4) Curtain air bag modules
- (5) Retractor pre-tensioner assemblies
- (6) Air bag warning light
- (7) SRS control module (SRSCM)/ Rollover sensor (if equipped)
- (8) Front impact sensors
- (9) Side impact sensors
- (10) Emergency fastening device system

* Front passenger's air bag ON/OFF lamp is located on the overhead console.

The SRSCM continually monitors all SRS components while the ignition switch or Engine Start/Stop button is ON to determine if a crash impact is severe enough to require air bag deployment or pre-tensioner seat belt deployment.



SRS warning light

The SRS (Supplemental Restraint System) air bag warning light on the instrument panel displays the air bag symbol depicted in the illustration. The system checks the air bag electrical system for malfunctions. The light indicates that there is a potential problem with your air bag system, which could include your side and/or curtain air bags used for rollover protection (if equipped with rollover sensor).



WARNING

If your SRS malfunctions, the air bag may not inflate properly during an accident, increasing the risk of serious injury or death.

If any of the following conditions occur, your SRS is malfunctioning:

- The light does not turn on for approximately three to six seconds when the ignition switch or Engine Start/Stop button is in the ON position.
- The light stays on after illuminating for approximately three to six seconds.
- The light comes on while the vehicle is in motion.
- The light blinks when the engine is running.

We recommend that an authorized HYUNDAI dealer inspect the SRS as soon as possible if any of these conditions occur.

During a moderate to severe frontal collision, sensors will detect the vehicle's rapid deceleration. If the rate of deceleration is high enough, the control unit will inflate the front air bags, at the time and with the force needed.

The front air bags help protect the driver and front passenger by responding to frontal impacts in which seat belts alone cannot provide adequate restraint. When needed, the side air bags help provide protection in the event of a side impact or rollover by supporting the side upper body area.

- Air bags are activated (able to inflate if necessary) when the ignition switch or Engine Start/Stop button is in the ON position or approximately within 3 minutes after ignition off.
- Air bags inflate in the event of certain frontal or side collisions to help protect the occupants from serious physical injury.
- There is no single speed at which the air bags will inflate. Generally, air bags are designed to inflate based upon the severity of a collision and its direction. These two factors determine whether the sensors produce an electronic deployment/inflation signal.
- Air bag deployment depends on a number of factors including vehicle speed, angles of impact and the density and stiffness of the vehicles or objects which your vehicle impacts during a collision. The determining factors are not limited to those mentioned above.
- The front air bags will completely inflate and deflate in an instant. It is virtually impossible for you to see the air bags inflate during an accident. It is much more likely that you will simply see the deflated air bags hanging out of their storage compartments after the collision.

- In addition to inflating in serious side collisions, vehicles equipped with a rollover sensor, side and/or curtain air bags will inflate if the sensing system detects a rollover.

When a rollover is detected, curtain air bags will remain inflated longer to help provide protection from ejection, especially when used in conjunction with the seat belts. (if equipped with a rollover sensor)

- To help provide protection, the air bags must inflate rapidly. The speed of air bag inflation is a consequence of extremely short time in which to inflate the air bag between the occupant and the vehicle structures before the occupant impacts those structures. This speed of inflation reduces the risk of serious or lifethreatening injuries and is thus a necessary part of air bag design. However, the rapid air bag inflation can also cause injuries which can include facial abrasions, bruises and broken bones because the inflation speed also causes the air bags to expand with a great deal of force.
- There are even circumstances under which contact with the air bag can cause fatal injuries, especially if the occupant is positioned excessively close to the air bag.

You can take steps to reduce the risk of being injured by an inflating air bag. The greatest risk is sitting too close to the air bag. An air bag needs space to inflate. It is recommended that the driver leave as much space as possible between their chest and the center of the steering wheel, while still being able to maintain control of the vehicle.



When the SRSCM detects a sufficiently severe impact to the front of the vehicle, it will automatically deploy the front air bags.



Upon deployment, tear seams molded directly into the pad covers will separate under pressure from the expansion of the air bags. Further opening of the covers allows full inflation of the air bags.

A fully inflated air bag, in combination with a properly worn seat belt, slows the driver's or the front passenger's forward motion, reducing the risk of head and chest injury.



After complete inflation, the air bag immediately starts deflating, enabling the driver to maintain forward visibility and the ability to steer or operate other controls.

 **WARNING**

To prevent objects from becoming dangerous projectiles when the passenger's air bag inflates:

- Do not install or place any objects (drink holder, CD holder, stickers, etc.) on the front passenger's panel above the glove box where the passenger's air bag is located.
- Do not install a container of liquid air freshener near the instrument cluster or on the instrument panel surface.

What to expect after an air bag inflates

After a frontal or side air bag inflates, it will deflate very quickly. Air bag inflation will not prevent the driver from seeing out of the windshield or being able to steer. Curtain air bags may remain partially inflated for some time after they deploy.



WARNING

After an air bag inflates, take the following precautions:

- Open your windows and doors as soon as possible after impact to reduce prolonged exposure to the smoke and powder released by the inflating air bag.
- Do not touch the air bag storage area's internal components immediately after an air bag has inflated. The parts that come into contact with an inflating air bag may be very hot.
- Always wash exposed skin areas thoroughly with cold water and mild soap.
- We recommend that an authorized HYUNDAI dealer replace the air bag immediately after deployment. Air bags are designed to be used only once.

Noise and smoke from inflating air bag

When the air bags inflate, they make a loud noise and may produce smoke and powder in the air inside of the vehicle. This is normal and is a result of the ignition of the air bag inflator. After the air bag inflates, you may feel substantial discomfort in breathing because of the contact of your chest with both the seat belt and the air bag, as well as from breathing the smoke and powder. The powder may aggravate asthma for some people. If you experience breathing problems after an air bag deployment, seek medical attention immediately.

Though the smoke and powder are nontoxic, they may cause irritation to the skin, eyes, nose, throat, etc. If this is the case, wash and rinse with cold water immediately and seek medical attention if the symptoms persist.

Do not install a Child Restraint System on the front passenger seat



OHI038169L

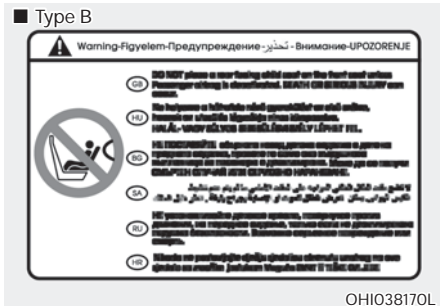

OHI038170L

Never install a Child Restraint System in the front passenger seat, unless the air bag is deactivated

WARNING

NEVER use a rearward facing Child Restraint on a seat protected by an **ACTIVE AIRBAG** in front of it, **DEATH** or **SERIOUS INJURY** to the **CHILD** can occur.

Why didn't my air bag go off in a collision?

There are certain types of accidents in which the air bag would not be expected to provide additional protection. These include rear impacts, second or third collisions in multiple impact accidents, as well as low speed impacts. Damage to the vehicle indicates a collision energy absorption, and is not an indicator of whether or not an air bag should have inflated.

Air bag collision sensors



WARNING

To reduce the risk of an air bag deploying unexpectedly and causing serious injury or death:

- Do not hit or allow any objects to impact the locations where air bags or sensors are installed.
- Do not perform maintenance on or around the air bag sensors. If the location or angle of the sensors is altered, the air bags may deploy when they should not or may not deploy when they should.
- Installing bumper guards with non-genuine Hyundai or non-equivalent parts may adversely affect the collision and airbag deployment performance.

To ensure correct function of the airbag system we recommend to replace the bumper with genuine Hyundai part or the equivalent (of the genuine part) specified for your vehicle.

- Place the ignition key or Engine Start/Stop button to the LOCK/OFF or ACC position and wait for 3 minutes when the vehicle is being towed to prevent inadvertent air bag deployment.
- We recommend that all air bag repairs performed by an authorized HYUNDAI dealer.



ONX4I032005/ONX4E030103R/ONX4E030104R/ONX4030043/ONX4030045

- 1. SRS control module / Rollover sensor*
- 2. Front impact sensor

- 3. Side impact sensor (Acceleration)*
- 4. Side impact sensor (Acceleration)*

* : if equipped

Air bag inflation conditions



Front air bags

Front air bags are designed to inflate in a frontal collision depending on the severity of impact of the front collision.



Side and curtain air bags

Side and curtain air bags are designed to inflate when an impact is detected by side collision sensors depending on the severity from a side impact collision.

Although the driver's and front passenger's air bags are designed to inflate in frontal collisions, they also may inflate in other types of collisions if the front impact sensors detect a sufficient impact. Side and curtain air bags are designed to inflate in side impact collisions, but they may inflate in other collisions if the side impact sensors detect a sufficient impact.

Also, the side and curtain air bags are designed to inflate when a rollover is detected by a rollover sensor. (if equipped with rollover sensor)

If the vehicle chassis is impacted by bumps or objects on unimproved roads, the air bags may deploy. Drive carefully on unimproved roads or on surfaces not designed for vehicle traffic to prevent unintended air bag deployment.

Air bag non-inflation conditions



In certain low-speed collisions the air bags may not deploy. The air bags are designed not to deploy in such cases because they may not provide benefits beyond the protection of the seat belts.



Front air bags are not designed to inflate in rear collisions, because occupants are moved backward by the force of the impact. In this case, inflated air bags would not provide any additional benefit.



Front air bags may not inflate in side impact collisions, because occupants move in the direction of the collision, and thus in side impacts, front air bag deployment would not provide additional occupant protection.

However, side and curtain air bags may inflate depending on the severity of impact.



In an angled collision, the force of impact may direct the occupants in a direction where the air bags would not be able to provide any additional benefit, and thus the sensors may not deploy any air bags.



ONX4030051

Just before impact, drivers often brake heavily. Such heavy braking lowers the front portion of the vehicle causing it to “ride” under a vehicle with a higher ground clearance. Air bags may not inflate in this “underride” situation because deceleration forces that are detected by sensors may be significantly reduced by such “underride” collisions.



ONX4030053

Front air bags may not inflate in rollover accidents because front air bag deployment would not provide additional occupant protection.

i Information

- **Vehicles equipped with rollover sensor**
The side and curtain air bags may inflate in a rollover situation, when it is detected by the rollover sensor.
- **Vehicles not equipped with rollover sensor**

The side and/or curtain air bags may inflate when the vehicle is rolled over by a side impact collision, if the vehicle is equipped with side and/or curtain air bags.



ONX4030052

Air bags may not inflate if the vehicle collides with objects such as utility poles or trees, where the point of impact is concentrated and the collision energy is absorbed by the vehicle structure.

SRS care

The SRS is virtually maintenance-free and there are no parts you can safely service by yourself. If the SRS air bag warning light does not illuminate when the ignition switch or Engine Start/ Stop button is in the ON position, or continuously remains on, we recommend that the system be immediately inspected by an authorized HYUNDAI dealer.

We recommend any work on the SRS system, such as removing, installing, repairing, or any work on the steering wheel, the front passenger's panel, front seats and roof rails be performed by an authorized HYUNDAI dealer. Improper handling of the SRS system may result in serious personal injury.



WARNING

To reduce the risk of serious injury or death take the following precautions:

- Do not attempt to modify or disconnect the SRS components or wiring, including the addition of any kind of badges to the pad covers or modifications to the body structure.
- Do not place objects over or near the air bag modules on the steering wheel, instrument panel, and the front passenger's panel above the glove box.
- Clean the air bag pad covers with a soft cloth moistened with plain water. Solvents or cleaners could adversely affect the air bag covers and proper deployment of the system.
- We recommend that inflated air bags replaced by an authorized HYUNDAI dealer.
- If components of the air bag system must be discarded, or if the vehicle must be scrapped, certain safety precautions must be observed. We recommend that you consult an authorized HYUNDAI dealer for the necessary information. Failure to follow these precautions could increase the risk of personal injury.

Additional safety precautions

Passengers should not move out of or change seats while the vehicle is moving. A passenger who is not wearing a seat belt during a crash or emergency stop can be thrown against the inside of the vehicle, against other occupants, or be ejected from the vehicle.

Do not use any accessories on seat belts. Devices claiming to improve occupant comfort or reposition the seat belt can reduce the protection provided by the seat belt and increase the chance of serious injury in a crash.

Do not modify the front seats. Modification of the front seats could interfere with the operation of the supplemental restraint system sensing components or side air bags.

Do not place items under the front seats. Placing items under the front seats could interfere with the operation of the supplemental restraint system sensing components and wiring harnesses.

Do not cause impact to the doors. Impact to the doors when the ignition switch or Engine Start/Stop button is in the ON or START position may cause the air bags to inflate.

Adding equipment to or modifying your air bag equipped vehicle

If you modify your vehicle by changing your vehicle's frame, bumper system, front end or side sheet metal or ride height, this may affect the operation of your vehicle's air bag system.

Air bag warning labels



Air bag warning labels are attached to alert the passengers of potential risks of the air bag system.

Be sure to read all of the information about the air bags that are installed on your vehicle in this Owner's Manual.

4. Instrument Cluster

Instrument cluster	4-4
Instrument cluster control	4-5
Instrument panel illumination	4-5
Gauges and meters	4-5
Speedometer	4-5
Tachometer	4-6
Engine coolant temperature gauge	4-6
Fuel gauge	4-7
Outside temperature gauge	4-8
Odometer	4-8
Distance to empty	4-8
Fuel economy (for 10.25-inch cluster)	4-9
Transmission shift indicator	4-10
Automatic transmission shift indicator	4-10
Automatic shift indicator in Manual Shift mode	4-10
Warning and indicator lights	4-11
Seat belt warning light	4-11
Air bag warning light	4-11
Parking brake & Brake fluid warning light	4-11
Anti-lock Brake System (ABS) warning light	4-12
Electronic Brake Force Distribution (EBD) system warning light	4-12
Electric Power Steering (EPS) warning light	4-13
Charging system warning light	4-13
Engine oil pressure warning light	4-14
Engine Oil Level Warning Light	4-14
Engine coolant temperature warning light	4-15
Low fuel level warning light	4-15
Malfunction Indicator Lamp (MIL)	4-15
Fuel filter warning light (for diesel engine)	4-16
Exhaust system (GPF) warning light (for gasoline engine)	4-17
Exhaust system (DPF) warning light (for diesel engine)	4-17
SCR warning light (for diesel engine)	4-17
Electronic Parking Brake (EPB) warning light	4-18
AUTO HOLD indicator light	4-18
Low tire pressure warning light	4-18
Forward Safety warning light	4-19
Lane Safety indicator light	4-19
Over speed warning light	4-19
4 Wheel Drive (4WD) warning light	4-20
4 Wheel Drive (4WD) LOCK Indicator Light	4-20
LED headlight warning light	4-20

Electronic Stability Control (ESC) indicator light.....	4-21
Electronic Stability Control (ESC) OFF indicator light.....	4-21
Immobilizer Indicator Light (without smart key).....	4-21
Immobilizer Indicator Light (with smart key).....	4-21
Glow indicator light (for diesel engine).....	4-22
Downhill Brake Control (DBC) indicator light.....	4-22
AUTO STOP indicator light.....	4-23
Turn signal indicator light.....	4-23
High beam indicator light.....	4-23
Low beam indicator light.....	4-23
Light ON indicator light.....	4-23
Rear fog indicator light.....	4-23
High Beam Assist indicator light.....	4-23
Cruise Indicator Light.....	4-24
SPORT Mode Indicator Light.....	4-24
ECO Mode Indicator Light.....	4-24
Master warning light.....	4-24
Icy Road Warning Light.....	4-25
LCD display messages.....	4-25
Shift to P (for smart key system).....	4-25
Low key battery (for smart key system).....	4-25
Press START button while turning wheel (for smart key system).....	4-25
Check steering wheel lock system (for smart key system).....	4-25
Press brake pedal to start engine (for smart key system and Automatic transmission).....	4-25
Press clutch pedal to start engine (for smart key system).....	4-26
Key not in vehicle (for smart key system).....	4-26
Key not detected (for smart key system).....	4-26
Press START button again (for smart key system).....	4-26
Press START button with key (for smart key system).....	4-26
Check BRAKE SWITCH fuse (for smart key system and Automatic transmission).....	4-26
Shift to N to start engine (for smart key system and Automatic transmission).....	4-26
Battery discharging due to external electrical devices.....	4-27
Door, Hood, Tailgate open indicator.....	4-27
Sunroof open indicator.....	4-27
Low tire pressure.....	4-27
Lights.....	4-28
Wiper.....	4-28

4. Instrument Cluster

Heated Steering Wheel turned off.....	4-29
Turn FUSE SWITCH On	4-29
Low washer fluid	4-29
Low fuel	4-29
Engine overheated / Engine has overheated.....	4-29
Check headlight	4-29
Check turn signal	4-29
Check headlamp LED	4-29
Low engine oil	4-30
Check High Beam Assist (HBA) system.....	4-30
Check Forward safety system	4-30
Check Driver Attention Warning system	4-30
Check Lane Keeping Assist (LKA) system	4-30
Check Blind-Spot safety system	4-31
Check exhaust system.....	4-31
Low urea (for diesel engine).....	4-31
Check urea system (for diesel engine)	4-31
LCD display.....	4-32
LCD display control	4-32
LCD display modes.....	4-33
Trip computer mode	4-34
Turn By Turn (TBT) mode	4-34
Driving Assist mode	4-34
Master warning group	4-35
Urea level (Diesel engine).....	4-36
Trip computer (4.2-inch)	4-37
Trip modes.....	4-37
Trip computer (10.25-inch)	4-40
Trip modes.....	4-40
Vehicle settings (infotainment system).....	4-43

INSTRUMENT CLUSTER

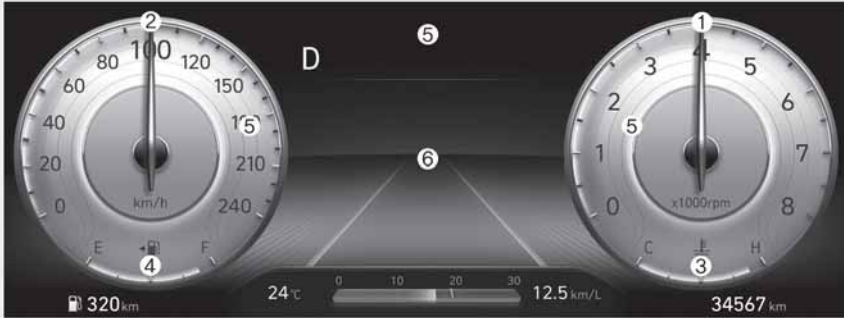

The actual instrument cluster in the vehicle may differ from the illustration. For more information, refer to “Gauges and meters” section in this chapter.

ONX41042001

- | | |
|-------------------------------------|---------------------------------|
| 1. Tachometer | 4. Fuel gauge |
| 2. Speedometer | 5. Warning and indicator lights |
| 3. Engine coolant temperature gauge | 6. LCD display |

Instrument cluster control

Instrument panel illumination



OCN7040019L

You can adjust the brightness of the instrument panel illumination from the User Settings Mode on the LCD display when the ignition switch is on ('Lights → Illumination'). When the vehicle's parking lights or headlamps are on, interior switch illumination intensity and mood lamps are also adjusted.

If your vehicle is equipped with additional navigation, please refer to the infotainment system manual separately supplied.

WARNING

Never adjust the instrument cluster while driving. This could result in loss of control and lead to an accident that may cause death, serious injury, or vehicle damage.

- The brightness of the instrument panel illumination is displayed.
- If the brightness reaches the maximum or minimum level, a chime will sound.

Gauges and meters

Speedometer



OCN7040005

The speedometer indicates the speed of the vehicle and is calibrated in kilometers per hour (km/h) and/or miles per hour (MPH).

Tachometer



The tachometer indicates the approximate number of engine revolutions per minute (rpm).

Use the tachometer to select the correct shift points and to prevent lugging and/or over-revving the engine.

NOTICE

Do not operate the engine within the tachometer's RED ZONE. This may cause severe engine damage.

Engine coolant temperature gauge



This gauge indicates the temperature of the engine coolant when the ignition switch is in the ON position.

NOTICE

If the gauge pointer moves beyond the normal range area toward the "H (Hot) or 130" position, it indicates overheating that may damage the engine.

Do not continue driving with an overheated engine. If your vehicle overheats, refer to "If the Engine Overheats" section in chapter 8.

**WARNING**

Never remove the engine coolant reservoir cap when the engine is hot. The engine coolant is under pressure and could cause severe burn. Wait until the engine is cool before adding coolant to the reservoir.

Fuel gauge

OTMO40012

This gauge indicates the approximate amount of fuel remaining in the fuel tank.

**Information**

- The fuel tank capacity is given in chapter 2.
- The fuel gauge is supplemented by a low fuel warning light, which will illuminate when the fuel tank is nearly empty.
- On inclines or curves, the fuel gauge pointer may fluctuate or the low fuel warning light may come on earlier than usual due to the movement of fuel in the tank.

**WARNING**

Running out of fuel can expose vehicle occupants to danger.

You must stop and obtain additional fuel as soon as possible after the warning light comes on or when the gauge indicator comes close to the "E (Empty) or 0" level.

NOTICE

Avoid driving with an extremely low fuel level. Running out of fuel could cause the engine to misfire damaging the catalytic converter.

Outside temperature gauge



OTM040013

This gauge indicates the current outside air temperatures by 1°C (1°F).

Note that the temperature indicated on the LCD display may not change as quickly as the outside temperature (there may be a slight delay before the temperature changes.)

You can change the temperature unit from the Settings menu in the Cluster. Select:

- Setup → Unit → Temperature Unit → °C/°F

For vehicles equipped with Automatic Climate Control, you can also:

- Press the AUTO button while pressing the OFF button on the climate control unit for 3 seconds

Both the temperature unit on the cluster LCD display and climate control screen will change.

Odometer



ONX4I042002

The odometer indicates the total distance that the vehicle has been driven and should be used to determine when periodic maintenance should be performed.

Distance to empty



ONX4I042003

- The distance to empty is the estimated distance the vehicle can be driven with the remaining fuel.
- If the estimated distance is below 1 km (1 mi.), the trip computer will display “---” as distance to empty.

i Information

- If the vehicle is not on level ground or the battery power has been interrupted, the distance to empty function may not operate correctly.
- The distance to empty may differ from the actual driving distance as it is an estimate of the available driving distance.
- The trip computer may not register additional fuel if less than 6 liters (1.5 gallon) of fuel are added to the vehicle.
- The distance to empty may vary significantly based on driving conditions, driving habits, and condition of the vehicle.

Fuel economy (for 10.25-inch cluster)

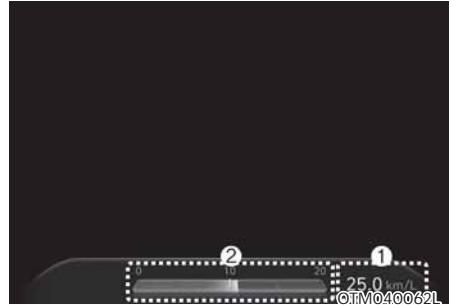

The average fuel economy (1) and instant fuel economy (2) is displayed at the bottom of the cluster.

Automatic reset

To automatically reset the average fuel economy, select between "After Ignition" or "After Refueling" from the Settings menu in the infotainment system screen.

Transmission shift indicator
Automatic transmission shift indicator (if equipped)



This indicator informs the current gear engaged.

Automatic shift indicator in Manual Shift mode (if equipped)



In the manual shift mode, this indicator informs which gear is desired while driving to save fuel.

- Automatic transmission shift indicator (6 speed transmission)
 - Shifting up : ▲2, ▲3, ▲4, ▲5, ▲6
 - Shifting down : ▼1, ▼2, ▼3, ▼4, ▼5
- Automatic transmission shift indicator (8 speed transmission)
 - Shifting up : ▲2, ▲3, ▲4, ▲5, ▲6, ▲7, ▲8
 - Shifting down : ▼1, ▼2, ▼3, ▼4, ▼5, ▲6, ▲7

When the system is not working properly, the indicator is not displayed.

Warning and indicator lights

Information

Make sure that all warning lights are OFF after starting the engine. If any light is still ON, this indicates a situation that needs attention.

Seat belt warning light



This warning light informs the driver that the seat belt is not fastened.

For more details, refer to “Seat Belts” section in chapter 3.

Air bag warning light



This warning light illuminates:

- When you turn the ignition switch or the Engine Start/Stop button to the ON position.
 - It illuminates for approximately 3~6 seconds and then goes off.
- When there is a malfunction with the SRS.

In this case, we recommend that you have the vehicle inspected by an authorized HYUNDAI dealer.

Parking brake & Brake fluid warning light



This warning light illuminates:

- When you set the ignition switch or the Engine Start/Stop button to the ON position.
 - The parking brake & brake fluid warning light illuminates for about 3 seconds and will then turn off once the parking brake is released.
- Whenever the parking brake is applied.
- Whenever the brake fluid level in the reservoir is low.
 - If the warning light illuminates with the parking brake released, it indicates the brake fluid level in the reservoir is low.

If the brake fluid level in the reservoir is low:

1. Drive carefully to the nearest safe location and stop your vehicle.
2. With the engine stopped, check the brake fluid level immediately and add fluid as required (**For more details, refer to “Brake Fluid” section in chapter 9**). After adding brake fluid, check all brake components for fluid leaks. If a brake fluid leak is found, or if the warning light remains on, or if the brakes do not operate properly, do not drive the vehicle. We recommend that you have the vehicle inspected by an authorized HYUNDAI dealer.

Dual-diagonal braking system

Your vehicle is equipped with dual-diagonal braking system. This means you still have braking on two wheels even if one of the dual systems should fail.

With only one of the dual systems working, more than normal pedal travel and greater pedal pressure is required to stop the vehicle.

Also, the vehicle will not stop in as short a distance with only a portion of the brake system working.

If the brakes fail while you are driving, shift to a lower gear for additional engine braking and stop the vehicle as soon as it is safe to do so.



WARNING

Parking Brake & Brake Fluid warning light

Driving the vehicle with a warning light ON is dangerous. If the Parking Brake & Brake Fluid warning light illuminates with the parking brake released, it indicates that the brake fluid level is low.

If this occurs, we recommend that you have the vehicle inspected by an authorized HYUNDAI dealer.

Anti-lock Brake System (ABS) warning light



This warning light illuminates:

- When you set the ignition switch or the Engine Start/Stop button to the ON position.
 - The ABS warning light illuminates for about 3 seconds and then goes off.
- Whenever there is a malfunction with the ABS.

Note that the hydraulic braking system will still be operational even if there is a malfunction with the ABS.

If this occurs, we recommend that you have the vehicle inspected by an authorized HYUNDAI dealer.

Electronic Brake Force Distribution (EBD) system warning light



When the ABS warning and Parking Brake warning lights are on simultaneously, it may indicate a problem with the Electronic Brake Force Distribution system.

If this occurs, we recommend that you have the vehicle inspected by an authorized HYUNDAI dealer.

**WARNING**

Electronic Brake Force Distribution (EBD) system warning light

When both ABS and Parking Brake & Brake Fluid warning lights are on, the brake system will not work normally and you may experience an unexpected and dangerous situation during sudden braking.

If this occurs, avoid high speed driving and abrupt braking.

We recommend that you have the vehicle inspected by an authorized HYUNDAI dealer as soon as possible.

NOTICE

Electronic Brake Force Distribution (EBD) system warning light

When the ABS warning light is on or both ABS and Parking Brake & Brake Fluid warning lights are on, the speedometer, odometer, or tripmeter may not work. Also, the EPS warning light may illuminate and the steering effort may increase or decrease.

If this occurs, we recommend that you have the vehicle inspected by an authorized HYUNDAI dealer as soon as possible.

Electric Power Steering (EPS) warning light

This warning light illuminates:

- When you set the ignition switch or the Engine Start/Stop button to the ON position.
 - The electric power steering warning light illuminates for about 3 seconds and then goes off.
- Whenever there is a malfunction with the electric power steering.

If this occurs, we recommend that you have the vehicle inspected by an authorized HYUNDAI dealer.

Charging system warning light

This warning light illuminates:

When there is a malfunction with either the alternator or electrical charging system.

If there is a malfunction with either the alternator or electrical charging system:

1. Drive carefully to the nearest safe location and stop your vehicle.
2. Turn the engine off and check the alternator drive belt for looseness or breakage.

If the belt is adjusted properly, there may be a problem in the electrical charging system.

If this occurs, we recommend that you have the vehicle inspected by an authorized HYUNDAI dealer as soon as possible.

Engine oil pressure warning light



This warning light illuminates:
When the engine oil pressure is low.

If the engine oil pressure is low:

1. Drive carefully to the nearest safe location and stop your vehicle.
2. Turn the engine off and check the engine oil level (For more details, refer to “Engine Oil” section in chapter 9). If the level is low, add oil as required.

If the warning light remains on after adding oil or if oil is not available, we recommend that you have the vehicle inspected by an authorized HYUNDAI dealer as soon as possible. (Continued driving with the warning light on may cause engine failure.)

i Information

When engine oil pressure decreases due to insufficient engine oil, etc., the Engine Oil Pressure warning light will illuminate. In addition, the enhanced engine protection system which limits engine power will be activated. If the engine oil pressure is restored, the Engine Oil Pressure warning light and the enhanced engine protection system will turn off. However, (for gasoline 2.5 gdi or 2.5 turbo gdi engine, when the engine oil pressure is restored, the warning light and the enhanced engine protection system will turn off after the engine is restarted.)

NOTICE

- If the engine is not stopped immediately after the Engine Oil Pressure warning light is illuminated, severe damage could result.

Engine Oil Level Warning Light (if equipped)



This warning light illuminates:

- Once you set the ignition switch or Engine Start/Stop Button to the ON position
 - It remains on until the engine is started.
- When the engine oil level should be checked.

If the engine oil level is low:

1. Drive carefully to the nearest safe location and stop your vehicle.
2. Turn the engine off and check the engine oil level (For more details, refer to “Engine Oil” in chapter 9). If the level is low, add oil as required. If the warning light remains on after adding oil or if oil is not available, we recommend that you have the vehicle inspected by an authorized HYUNDAI dealer as soon as possible.

Engine coolant temperature warning light (if equipped)



The warning light illuminates:

When the temperature of the engine coolant is extremely high.

Do not continue driving with an overheated engine. If your vehicle overheats, refer to “Overheating” section in chapter 8.

NOTICE

If the Engine Coolant Temperature warning light illuminates, it indicates overheating that may damage the engine.

Low fuel level warning light



This warning light illuminates:

When the fuel tank is nearly empty.
Add fuel as soon as possible.

NOTICE

Driving with the Low Fuel Level warning light on or with the fuel level below “E or 0” can cause the engine to misfire and damage the catalytic converter.

Malfunction Indicator Lamp (MIL)



This indicator light illuminates:

- When you set the ignition switch or the Engine Start/Stop button to the ON position.
 - The malfunction indicator light illuminates for about 3 seconds and then goes off.
- Whenever there is a malfunction with either the emission control system or the engine or the vehicle powertrain. If this occurs, we recommend that you have the vehicle inspected by an authorized HYUNDAI dealer.

NOTICE

- Driving with the Malfunction Indicator Lamp (MIL) on may cause damage to the emission control system which could affect drivability and/or fuel economy.
- If the enhanced engine protection system becomes activated due to lack of engine oil, engine power will be limited. If such condition continues repeatedly, the Malfunction Indicator Lamp will illuminate.

NOTICE

- Gasoline engine

If the Malfunction Indicator Lamp (MIL) illuminates, potential catalytic converter damage is possible which could result in loss of engine power.

If this occurs, we recommend that you have the vehicle inspected by an authorized HYUNDAI dealer as soon as possible.

- Diesel engine

If the Malfunction Indicator Lamp (MIL) blinks, an error related to the engine control system may have occurred which could result in loss of engine power, combustion noise and poor emission.

If this occurs, we recommend that you have the vehicle inspected by an authorized HYUNDAI dealer.

- If the oil pressure lowers due to insufficient engine oil, etc., the engine oil pressure warning light turns on and an enhanced engine protection system that limits the engine's power is activated. After that, engine warning light turns on if driving repeatedly and continuously.

NOTICE

Diesel engine with DPF

When the Malfunction Indicator Lamp (MIL) blinks, it may stop blinking after driving the vehicle:

- at more than 60km/h (37 mph), or
- at more than 2nd gear with 1250 ~ 2500 engine RPM for a certain time (for about 25 minutes).

If the Malfunction Indicator Lamp (MIL) continues to blink in spite of the procedure, we recommend that you have the DPF system checked by an authorized HYUNDAI dealer.

If you continue to drive with the Malfunction Indicator Lamp (MIL) blinking for a long time, the DPF system can be damaged and fuel consumption can worsen.

***Fuel filter warning light
(for diesel engine)***



This warning light illuminates:

When water has accumulated inside the fuel filter.

If this occurs, we recommend that you have the vehicle removed water from the fuel filter by an authorized HYUNDAI dealer.

For more details, refer to "Fuel Filter" section in chapter 9.

NOTICE

- When the Fuel Filter warning light illuminates, engine power (vehicle speed & idle speed) may decrease.
- If you keep driving with the warning light on, engine parts (injector, common rail, high pressure fuel pump) may be damaged. If this occurs, we recommend that you have the vehicle inspected by an authorized HYUNDAI dealer as soon as possible.

**Exhaust system (GPF)
warning light (for gasoline
engine, if equipped)**



- This warning light illuminates, when accumulated soot reaches a certain amount.
- When this warning light illuminates, it may turn off after driving the vehicle at more than 80 km/h (50 mph) for about 30 minutes (above 3rd gear with 1500 ~ 4000 engine RPM).

If this warning light blinks in spite of the procedure (at this time LCD warning message will be displayed), we recommend that you have the GPF system checked by an authorized HYUNDAI dealer.

NOTICE

If you continue to drive with the GPF warning light blinking for a long time, the GPF system can be damaged and fuel consumption can worsen.

**Exhaust system (DPF)
warning light (for diesel
engine, if equipped)**



- This warning light illuminates when there is a malfunction with the Diesel Particulate Filter (DPF) system.
- When this warning light illuminates, it may turn off after driving the vehicle at more than 60 km/h (37 mph) for about 30 minutes (above 2nd gear with 1250 ~ 2500 engine RPM).

If this warning light blinks in spite of the procedure (at this time LCD warning message will be displayed), we recommend that you have the DPF system checked by an authorized HYUNDAI dealer.

NOTICE

If you continue to drive with the DPF warning light blinking for a long time, the DPF system can be damaged and fuel consumption can worsen.

**SCR warning light (for diesel
engine, if equipped)**



This warning light illuminates:

When the urea solution tank is nearly empty.

If the urea solution tank is nearly empty, refill urea solution as soon as possible.

For more details, refer to "Selective Catalytic Reduction (SCR)" section in chapter 9.

Electronic Parking Brake (EPB) warning light (if equipped)

EPB

This warning light illuminates:

- When you set the ignition switch or the Engine Start/Stop button to the ON position.
 - The EPB warning light illuminates for about 3 seconds and then goes off.
- Whenever there is a malfunction with EPB.
If this occurs, we recommend that you have the vehicle inspected by an authorized HYUNDAI dealer.

i Information

The Electronic Parking Brake (EPB) warning light may illuminate when the Electronic Stability Control (ESC) indicator light comes on to indicate that ESC is not working properly. This does not indicate malfunction of EPB.

AUTO HOLD indicator light (if equipped)

AUTO HOLD

This indicator light illuminates:

- [White] When you activate Auto Hold by pressing the AUTO HOLD switch.
- [Green] When you stop the vehicle completely by depressing the brake pedal with Auto Hold activated.
- [Yellow] Whenever there is a malfunction with the Auto Hold function.

If this occurs, we recommend that you have the vehicle inspected by an authorized HYUNDAI dealer.

For more details, refer to “Electronic Parking Brake (EPB)” section in chapter 6.

Low tire pressure warning light (if equipped)



This warning light illuminates:

- When you set the ignition switch or the Engine Start/Stop button to the ON position.
 - The low tire pressure warning light illuminates for approximately 3 seconds and then goes off.
- When one or more of your tires are significantly underinflated. (The location of the underinflated tires are displayed on the LCD display.)

For more details, refer to “Tire Pressure Monitoring System (TPMS)” section in chapter 8.

This warning light remains ON after blinking for approximately 60 seconds, or repeatedly blinks ON and OFF in 3 second intervals:

When there is a malfunction with the TPMS.

If this occurs, we recommend that you have the vehicle inspected by an authorized HYUNDAI dealer as soon as possible.

For more details, refer to “Tire Pressure Monitoring System (TPMS)” section in chapter 8.

**WARNING****Safe Stopping**

- The TPMS cannot alert you to severe and sudden tire damage caused by external factors.
- If you notice any vehicle instability, immediately take your foot off the accelerator pedal, apply the brakes gradually with light force, and slowly move to a safe position off the road.

Forward Safety warning light (if equipped)**This warning light illuminates:**

- When you set the ignition switch or the Engine Start/Stop button to the ON position.
 - The Forward Safety warning light illuminates for approximately 3 seconds and then goes off.
- [Continuously Yellow] When Forward Collision-Avoidance Assist is Off/Disabled/Malfunction.
- [Blinking Red] When Forward Collision-Avoidance Assist is operating.

If this occurs, we recommend that you have the vehicle inspected by an authorized HYUNDAI dealer.

For more details, refer to "Forward Collision-Avoidance Assist (FCA)" section in chapter 7.

Lane Safety indicator light (if equipped)**This indicator light illuminates:**

- [Green] When Lane Keeping Assist operating conditions are satisfied.
- [White] When Lane Keeping Assist operating conditions are not satisfied.
- [Yellow] Whenever there is a malfunction with Lane Keeping Assist. If this occurs, we recommend that you have the vehicle inspected by an authorized HYUNDAI dealer.

For more details, refer to "Lane Keeping Assist (LKA)" section in chapter 7.

Over speed warning light (if equipped)**120**
km/h**This warning light blinks:**

When you drive the vehicle more than 120 km/h.

- This is to prevent you from over speeding.
- The over speed warning chime also sound for approximately 5 seconds.

4 Wheel Drive (4WD) warning light (if equipped)



This warning light illuminates:

Whenever there is a malfunction with the 4WD system.

If this occurs, we recommend that you have the vehicle inspected by an authorized HYUNDAI dealer.

For more details, refer to “4 Wheel Drive (4WD)” section in chapter 6.

4 Wheel Drive (4WD) LOCK Indicator Light (if equipped)



This indicator light illuminates:

- Once you set the ignition switch or Engine Start/Stop Button to the ON position.
 - It illuminates for approximately 3 seconds and then goes off.
- When you select 4WD Lock mode by pressing the 4WD LOCK button.
 - The 4WD LOCK mode is to increase the drive power when driving on wet pavement, snow covered roads and/or off-road.

NOTICE

Do not use 4WD LOCK mode on dry paved roads or highway, it can cause noise, vibration or damage of 4WD related parts.

LED headlight warning light



This warning light illuminates:

- When you set the ignition switch or the Engine Start/Stop button to the ON position.
 - The LED headlight warning light illuminates for approximately 3 seconds and then goes off.
- Whenever there is a malfunction with the LED headlight.
 - If this occurs, we recommend that you have the vehicle inspected by an authorized HYUNDAI dealer.

This warning light blinks:

Whenever there is a malfunction with a LED headlight related part.

If this occurs, we recommend that you have the vehicle inspected by an authorized HYUNDAI dealer.

NOTICE

Continuous driving with the LED Headlight warning light on or blinking can reduce LED headlight life.

Electronic Stability Control (ESC) indicator light (if equipped)



This indicator light illuminates:

- When you set the ignition switch or the Engine Start/Stop button to the ON position.
 - The Electronic Stability Control indicator light illuminates for about 3 seconds and then goes off.
- Whenever there is a malfunction with ESC system.

If this occurs, we recommend that you have the vehicle inspected by an authorized HYUNDAI dealer.

This indicator light blinks:

While ESC is operating.

For more details, refer to “Electronic Stability Control (ESC)” section in chapter 6.

Electronic Stability Control (ESC) OFF indicator light (if equipped)



This indicator light illuminates:

- When you set the ignition switch or the Engine Start/Stop button to the ON position.
 - The ESC OFF indicator light illuminates for approximately 3 seconds and then goes off.
- When you deactivate ESC system by pressing the ESC OFF button.

For more details, refer to “Electronic Stability Control (ESC)” section in chapter 6.

Immobilizer Indicator Light (without smart key) (if equipped)



This indicator light illuminates:

- When the vehicle detects the immobilizer in the key with the ignition switch in the ON position.
 - At this time, you can start the engine.
 - The indicator light goes off after starting the engine.

This indicator light blinks:

- When there is a malfunction with the immobilizer system.

In this case, we recommend that you have the vehicle inspected by an authorized HYUNDAI dealer.

Immobilizer Indicator Light (with smart key) (if equipped)



This indicator light illuminates for up to 30 seconds:

- When the vehicle detects the smart key in the vehicle with the Engine Start/Stop button in the ACC or ON position.
 - At this time, you can start the engine.
 - The indicator light goes off after starting the engine.

This indicator light blinks for a few seconds:

- When the smart key is not in the vehicle.
 - At this time, you cannot start the engine.

This indicator light illuminates for 2 seconds and goes off:

- If the smart key is in the vehicle and the Engine Start/Stop button is ON, but the vehicle cannot detect the smart key.

In this case, we recommend that you have the vehicle inspected by an authorized HYUNDAI dealer.

This indicator light blinks:

- When there is a malfunction with the immobilizer system.

In this case, we recommend that you have the vehicle inspected by an authorized HYUNDAI dealer.

***Glow indicator light
(for diesel engine)***



This indicator light illuminates:

When the engine is being preheated with the ignition switch or the Engine Start/Stop button to the ON position.

- The engine can be started after the glow indicator light goes off.
- The illumination time varies depending on the engine coolant temperature, air temperature, and battery condition.

If the indicator light remains on or blinks after the engine has warmed up or while driving, there may be a malfunction with the engine preheating system.

If this occurs, we recommend that you have the vehicle inspected by an authorized HYUNDAI dealer.

***Downhill Brake Control (DBC)
indicator light (if equipped)*** 

This indicator light illuminates:

- When you set the ignition switch or the Engine Start/Stop button to the ON position.
 - The downhill brake control indicator light illuminates for about 3 seconds and then goes off.
- When you activate the system by pressing the DBC button.

This indicator light blinks:

When Downhill Brake Control system is operating.

This indicator light illuminates yellow:

Whenever there is a malfunction with Downhill Brake Control system.

If this occurs, we recommend that you have the vehicle inspected by an authorized HYUNDAI dealer.

For more details, refer to "Downhill Brake Control (DBC)" section in chapter 6.

**AUTO STOP indicator light
(if equipped)****This indicator light illuminates:**

When the engine enters the Idle Stop mode of ISG (Idle Stop and Go) system.
When the engine automatically starts, the AUTO STOP indicator on the cluster illuminates to white.

For more details, refer to "ISG (Idle Stop and Go) system" section in chapter 6.

i Information

When the engine automatically starts by the ISG system, some warning lights (ABS, ESC, ESC OFF, EPS or Parking brake warning light) may turn on for a few seconds. This happens because of low battery voltage. It does not mean the system has malfunctioned.

Turn signal indicator light**This indicator light blinks:**

When you operate the turn signal indicator stalk.

If any of the following occur, there may be a malfunction with the turn signal system.

- The turn signal indicator light illuminates but does not blink
- The turn signal indicator light blinks rapidly
- The turn signal indicator light does not illuminate at all

If any of these conditions occur, we recommend that you have the vehicle inspected by an authorized HYUNDAI dealer.

High beam indicator light**This indicator light illuminates:**

- When the headlamps are on and in the high beam position
- When the turn signal lever is pulled into the Flash-to-Pass position.

Low beam indicator light**This indicator light illuminates:**

When the headlamps are on.

Light ON indicator light**This indicator light illuminates:**

When the position lamps or headlamps are on.

**Rear fog indicator light
(if equipped)****This indicator light illuminates:**

When the rear fog lamps are on.

**High Beam Assist indicator light
(if equipped)****This indicator light illuminates:**

When the high-beam is on with the light switch in the AUTO position.

- White: When High Beam Assist is ready to operate.
- Green: When High Beam Assist is operating.

If your vehicle detects oncoming or preceding vehicles, High Beam Assist will switch the high beam to low beam automatically.

For more details, refer to "High Beam Assist (HBA)" section in chapter 5.

**Cruise Indicator Light
(if equipped)**



This indicator light illuminates:

When cruise control is enabled.

For more details, refer to "Cruise Control (CC)" in chapter 7.

**SPORT Mode Indicator Light
(if equipped)**



This indicator light illuminates

When you select "SPORT" mode as drive mode.

For more details, refer to "Drive Mode Integrated Control System" in chapter 6.

**ECO Mode Indicator Light
(if equipped)**



This indicator light illuminates

When you select "ECO" mode as drive mode.

For more details, refer to "Drive Mode Integrated Control System" in chapter 6.

Master warning light



This warning light illuminates:

When there is a malfunction in operation in any of the following systems:

- Forward Collision-Avoidance Assist malfunction (if equipped)
- Forward Collision-Avoidance Assist radar blocked (if equipped)
- Blind-Spot Collision-Avoidance Assist malfunction (if equipped)
- Blind-Spot Collision-Avoidance Assist radar blocked (if equipped)
- LED headlamp malfunction (if equipped)
- High Beam Assist malfunction (if equipped)
- Smart Cruise Control malfunction (if equipped)
- Smart Cruise Control radar blocked (if equipped)
- Tire Pressure Monitoring System (TPMS) malfunction

To identify the details of the warning, look at the LCD display.

Icy Road Warning Light (if equipped)



This indicator light illuminates:

This warning light is to warn the driver the road may be icy.

When the temperature on the outside temperature gauge is approximately below 4°C (40°F), the Icy Road Warning Light and Outside Temperature Gauge blinks and then illuminates. Also, the warning chime sounds 1 time.

The Icy Road Warning function can be activated or deactivated from the User Settings mode in the cluster LCD display.



Information

If the icy road warning light appears while driving, you should drive more attentively and safely, refraining from over-speeding, rapid acceleration, sudden braking or sharp turning, etc.

LCD display messages

Shift to P (for smart key system)

This message is displayed if you try to turn off the vehicle without the gear in the P (Park) position.

If this occurs, the Engine Start/Stop button turns to the ACC position.

Low key battery (for smart key system)

This message is displayed if the battery of the smart key is discharged while changing the Engine Start/Stop button to the OFF position.

Press START button while turning wheel (for smart key system)

This message is displayed if the steering wheel does not unlock normally when the Engine Start/Stop button is pressed.

You should press the Engine Start/Stop button while turning the steering wheel right and left.

Check steering wheel lock system (for smart key system)

This message is displayed if the steering wheel does not lock normally while the Engine Start/Stop button is pressed to the OFF position.

Press brake pedal to start engine (for smart key system and Automatic transmission)

This message is displayed if the Engine Start/Stop button changes to the ACC position twice by pressing the button repeatedly without depressing the brake pedal.

You can start the vehicle by depressing the brake pedal and then pressing the Engine Start/Stop button.

Press clutch pedal to start engine (for smart key system)

This warning message is displayed if the Engine Start/Stop button is in the ACC position twice by pressing the button repeatedly without depressing the clutch pedal.

Depress the clutch pedal to start the engine.

Key not in vehicle (for smart key system)

This message is displayed if the smart key is not in the vehicle when you leave the vehicle with the Engine Start/Stop button in the ON or Start position.

Always turn off the engine before leaving your vehicle.

Key not detected (for smart key system)

This message is displayed if the smart key is not detected when you press the Engine Start/Stop button.

Press START button again (for smart key system)

This message is displayed if you were unable to start the vehicle when the Engine Start/Stop button was pressed.

If this occurs, attempt to start the engine by pressing the Engine Start/ Stop button again.

If the warning message appears each time you press the Engine Start/Stop button, we recommend that you have the vehicle inspected by an authorized HYUNDAI dealer.

Press START button with key (for smart key system)

This message is displayed if you press the Engine Start/Stop button while the warning message "Key not detected" is displayed.

At this time, the immobilizer indicator light blinks.

Check BRAKE SWITCH fuse (for smart key system and Automatic transmission)

This message is displayed if the brake switch fuse is disconnected.

You need to replace the fuse with a new one before starting the engine.

If that is not possible, you can start the engine by pressing the Engine Start/ Stop button for 10 seconds in the ACC position.

Shift to N to start engine (for smart key system and Automatic transmission)

This warning message is displayed if you try to start the engine with the shift lever not in the N (Neutral) position.

***i* Information**

You can start the engine with the gear in N (Neutral). But, for your safety, we recommend that you start the engine with the gear shifted to P (Park).

Battery discharging due to external electrical devices (if equipped)

This message is displayed if the 12V battery voltage is weak due to any non-factory electrical accessories (for example, dashboard camera) while parking. Be careful that the battery is not discharged.

If the message appears after removing the non-factory electrical accessories, have the vehicle inspected by an authorized HYUNDAI dealer.

Door, Hood, Tailgate open indicator

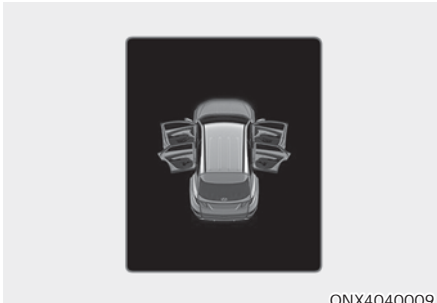

This warning is displayed if any door or hood or tailgate is left open. The warning will indicate which door is open in the display.



CAUTION

Before driving the vehicle, you should confirm that the door/ hood/tailgate are fully closed.

Sunroof open indicator (if equipped)



This warning is displayed if you turn off the engine when the sunroof is open. Close the sunroof securely before leaving your vehicle.

Low tire pressure



This warning message is displayed if the tire pressure is low. The corresponding tire on the vehicle will be illuminated.

For more details, refer to "Tire Pressure Monitoring System (TPMS)" section in chapter 8.

Lights

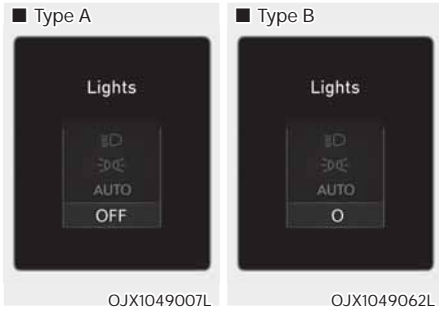

This indicator displays which exterior light is selected using the lighting control.

You can activate or deactivate Wiper/Lights display function from the User Settings menu in the cluster LCD display.

Select:

- Setup → User settings → Cluster → Wiper/Lights display

Wiper

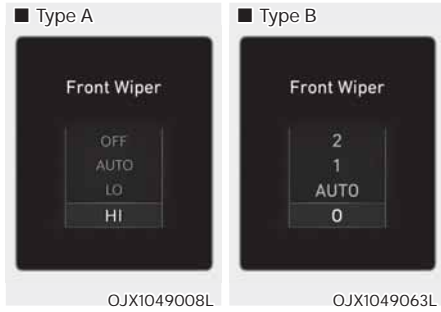

This indicator displays which wiper speed is selected using the wiper control.

You can activate or deactivate Wiper/Lights display function from the User Settings menu in the cluster LCD display.

Select:

- Setup → User settings → Cluster → Wiper/Lights display

Heated Steering Wheel turned off (if equipped)

This message is displayed if you turn off the heated steering wheel.

For more details, refer to “Heated Steering Wheel” in chapter 5.

Turn FUSE SWITCH On (if equipped)

This warning message illuminates if the fuse switch located on the fuse box under the steering wheel is OFF. You should turn the fuse switch on.

For more details, refer to “Fuses” in chapter 9.

Low washer fluid (if equipped)

This message is displayed if the washer fluid level in the reservoir is nearly empty. Have the washer fluid reservoir refilled.

Low fuel

This message is displayed if the fuel tank is almost out of fuel.

When this message is displayed, the low fuel level warning light in the cluster will come on.

It is recommended that you locate the nearest fueling station and refuel as soon as possible.

Engine overheated / Engine has overheated (if equipped)

This message is displayed when the engine coolant temperature is above 120°C (248°F). This means that the engine is overheated and may be damaged.

If your vehicle is overheated, refer to “Overheating” section in chapter 8.

Check headlight (if equipped)

This message is displayed if the headlights are not operating properly. A lamp may need to be replaced.

Make sure to replace the burned out bulb with a new one of the same wattage rating.

Check turn signal (if equipped)

This message is displayed if the turn signal lamps are not operating properly. A lamp may need to be replaced.

Make sure to replace the burned out bulb with a new one of the same wattage rating.

Check headlamp LED (if equipped)

This message is displayed if there is a problem with the LED headlamp. We recommend that you have the vehicle inspected by an authorized HYUNDAI dealer.

Low engine oil (if equipped)

This warning message is displayed when the engine oil level should be checked.

If this warning message is displayed, check the engine oil level as soon as possible and add engine oil as required.

Slowly pour the recommended oil little by little into a funnel. (Oil refill capacity : approximately 0.6 ~ 1.0 l)

Use only the specified engine oil. (Refer to "Recommended lubricants and capacities" in chapter 2.)

Do not overfill the engine oil. Make sure the oil level is not above F (Full) mark on the dipstick.

NOTICE

If the message is displayed continuously after adding the engine oil and travelling approximately 50~100 km after the engine warms up, we recommend that the system be checked by an authorized HYUNDAI dealer.

Even if this message is not displayed after the engine has started, the engine oil level should be periodically checked and topped up if required.

***i* Information**

If you travel approximately 50 km ~ 100 km after the engine warms up, after adding the engine oil, the warning message will be disappeared.

Check High Beam Assist (HBA) system (if equipped)

This warning message is displayed if there is a problem with the High Beam Assist. We recommend that you have the vehicle inspected by an authorized HYUNDAI dealer.

For more details, refer to "High Beam Assist (HBA)" in chapter 5.

Check Forward safety system (if equipped)

This warning message is displayed if there is a malfunction with the Forward Collision-Avoidance Assist. We recommend that you have the vehicle inspected by an authorized HYUNDAI dealer.

For more details, refer to "Forward Collision-Avoidance Assist (FCA)" in chapter 7.

Check Driver Attention Warning system (if equipped)

This warning message is displayed if there is a problem with the Driver Attention Warning. We recommend that you have the vehicle inspected by an authorized HYUNDAI dealer.

For more details, refer to "Driver Attention Warning (DAW)" in chapter 7.

Check Lane Keeping Assist (LKA) system (if equipped)

This warning message is displayed if there is a problem with the Lane Keeping Assist. We recommend that you have the vehicle inspected by an authorized HYUNDAI dealer.

For more details, refer to "Lane Keeping Assist (LKA)" in chapter 7.

Check Blind-Spot safety system (if equipped)

This warning message is displayed if there is a problem with the Blind-Spot Collision Warning. We recommend that you have the vehicle inspected by an authorized HYUNDAI dealer.

For more details, refer to "Blind-Spot Collision Warning (BCW)" in chapter 7.

Check exhaust system (if equipped)

This warning message illuminates if the DPF or GPF system has a malfunction. at this time, DPF or GPF warning light also blinks.

In this case, we recommend that you have the DPF or GPF system checked by an authorized HYUNDAI dealer.

DPF : Diesel Particulate Filter

GPF : Gasoline Particulate Filter

Low urea (for diesel engine) (if equipped)

This warning message illuminates if the urea solution level in the urea solution tank is nearly empty.

- When the SCR warning light is illuminates.

Refill urea solution as soon as possible.

For more details, refer to "Selective Catalytic Reduction (SCR) " in the chapter 9.

Check urea system (for diesel engine) (if equipped)

This warning message illuminates if the urea system has a malfunction.

In this case, we recommend that you have the urea system checked by an authorized HYUNDAI dealer.

For more details, refer to "Selective Catalytic Reduction (SCR) " in the chapter 9.



LCD DISPLAY

LCD display control







ONX4E040020/ONX4E040021

The LCD display modes can be changed by using the control buttons.

Switch	Function
	MODE button for changing modes
	MOVE switch for changing items
OK	SELECT/RESET button for setting or resetting the selected item

LCD display modes

Modes	Symbol	Explanation
Trip Computer		This mode displays driving information such as the tripmeter, fuel economy, etc. For more details, refer to "Trip Computer" in this chapter.
Turn By Turn (TBT)		This mode displays the state of the navigation.
Driving Assist		- Lane Keeping Assist - Smart Cruise Control For more information, refer to "Lane Keeping Assist (LKA)", "Smart Cruise Control (SCC)" in chapter 7.
User Settings		In this mode, you can change settings of the doors, lamps, etc.
Warning		This mode displays warning messages related to the lamp malfunction, etc. This mode displays information related to the tire pressure (TPMS), the state of driving force distribution and the amount of remaining urea solution.

The information provided may differ depending on which functions are applicable to your vehicle.

Trip computer mode

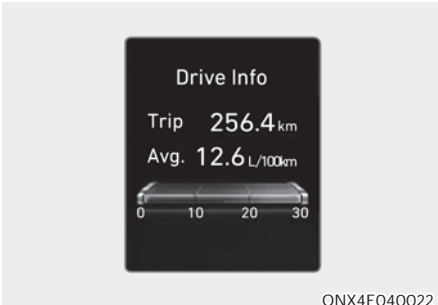

The trip computer mode displays information related to vehicle driving parameters including fuel economy, tripmeter information and vehicle speed. For more information, refer to "Trip Computer" in this chapter.

Turn By Turn (TBT) mode

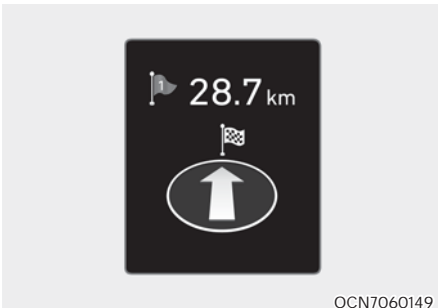

Turn-by-turn navigation, distance/time to destination information is displayed when Turn by Turn view is selected.

Driving Assist mode (If equipped)



LKA/SCC
This mode displays the state of Lane Keeping Assist and Smart Cruise Control. For more details, refer to each function information in chapter 7.



Driver Attention Warning
This mode displays the state of Driver Attention Warning. For more details, refer to "Driver Attention Warning (DAW)" in chapter 7.

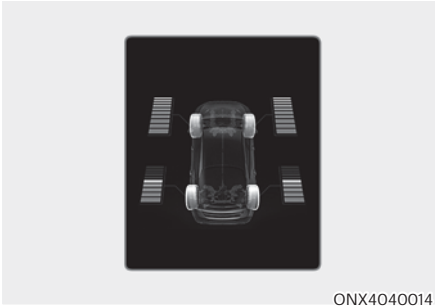

ONX4040014

Driving force distribution (4WD)

This mode displays information related to 4WD driving force.

If the vehicle is in 4WD lock state, this mode is not displayed.

For detailed information, refer to the "Four Wheel Drive" in the chapter 6.

Master warning group

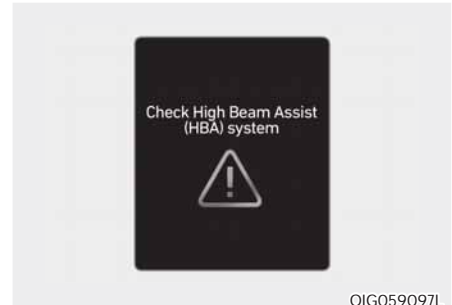

OIG059097L

This warning light informs the driver the following situations.

- Forward Collision-Avoidance Assist malfunction (if equipped)
- Forward Collision-Avoidance Assist radar blocked (if equipped)
- Blind-Spot Collision-Avoidance Assist malfunction (if equipped)
- Blind-Spot Collision-Avoidance Assist radar blocked (if equipped)
- LED headlamp malfunction (if equipped)
- High Beam Assist malfunction (if equipped)
- Smart Cruise Control malfunction (if equipped)
- Smart Cruise Control radar blocked (if equipped)
- Tire Pressure Monitoring System (TPMS) malfunction

The Master Warning Light illuminates if one or more of the above warning situations occur.

At this time, a Master Warning icon (⚠) will appear beside the User Settings icon (⚙), on the LCD display.

If the warning situation is solved, the master warning light will be turned off and the Master Warning icon will disappear.



ONX4E040023

Tire Pressure

This mode displays information related to Tire Pressure.

For more details, refer to "Tire Pressure Monitoring System (TPMS)" in chapter 8.

Urea level (Diesel engine)

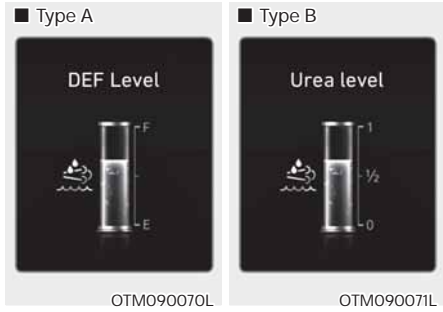

This mode displays the approximate amount of remaining urea solution inside the urea solution tank.

Add the urea before the level indicates "E" or "0".

For more details, refer to "Selective Catalytic Reduction (SCR)" in chapter 9.

Trip computer (4.2-inch)

The trip computer is a microcomputer-controlled driver information system that displays information related to driving.

i Information

Some driving information stored in the trip computer (for example Average Vehicle Speed) resets if the battery is disconnected.

Trip modes

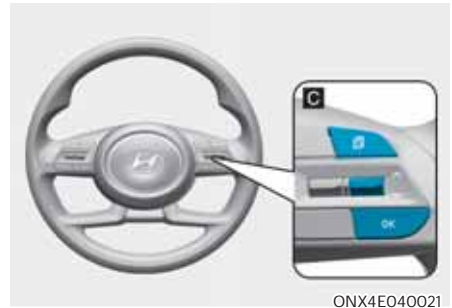
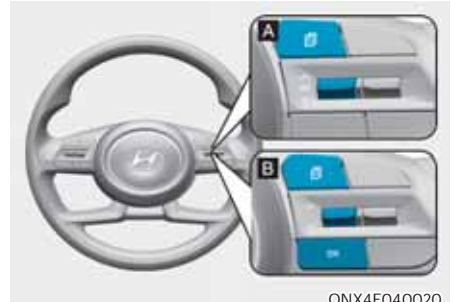
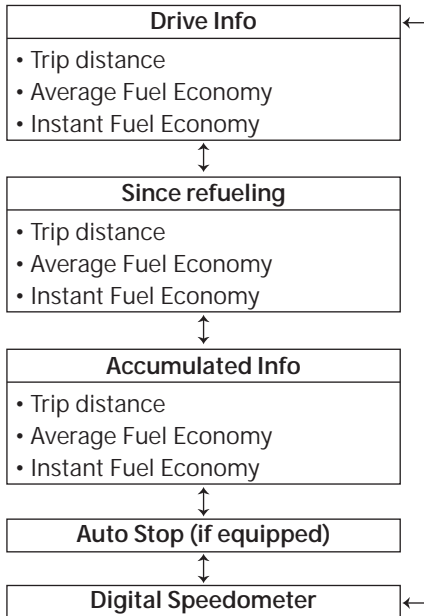

To change the trip mode, toggle the " \wedge , \vee " switch on the steering wheel.

- Manual reset
To clear the average fuel economy manually, press the OK switch on the steering wheel for more than 1 second when the Average Fuel Economy is displayed.
- Automatic reset
To automatically reset the average fuel economy, select between 'After Ignition' or 'After Refueling' from the Settings menu in the instrument cluster.
 - After Ignition: When the engine has been OFF for 3 minutes or longer the average fuel economy will reset automatically.
 - After Refueling: The average fuel economy will reset automatically after adding 6 liters (1.6 gallons) of fuel or more and after driving speed exceeds 1 km/h (1 mph).

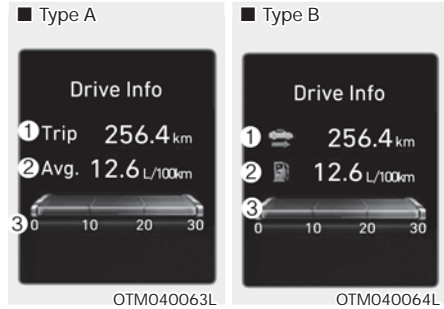

Drive info

Trip distance (1), average fuel economy (2), and instant fuel economy (3) are displayed.

The information is combined for each ignition cycle. However, when the engine has been OFF for 3 minutes or longer the Drive Info screen will reset.

To reset manually, press the OK switch on the steering wheel for more than 1 second when 'Drive Info' is displayed.

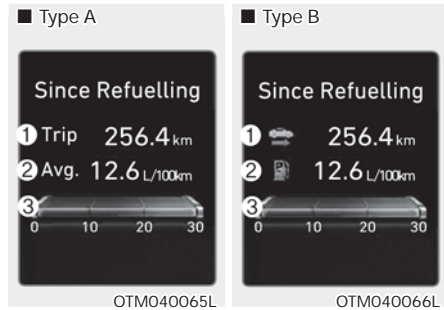

Since refuel(ing)

Trip distance (1), average fuel economy (2), and instant fuel economy (3) after the vehicle has been refueled are displayed.

To reset manually, press the OK switch on the steering wheel for more than 1 second when 'Since Refueling' is displayed.

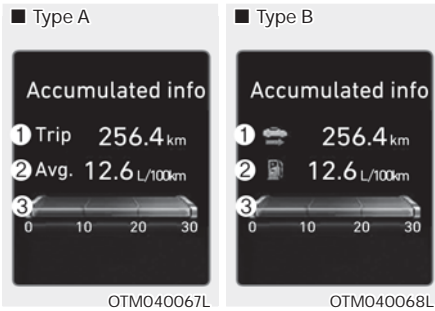

Accumulated info

Accumulated trip distance (1), average fuel economy (2), and instant fuel economy (3) are displayed.

The information is accumulated starting from the last reset.

To reset manually, press the OK switch on the steering wheel for more than 1 second when 'Accumulated Info' is displayed.



Auto stop (if equipped)

AUTO STOP display shows the elapsed time of engine stop by Idle Stop and Go system.

For more details, refer to "Idle Stop and Go (ISG)" section in chapter 6.



Digital speedometer

Digital speedometer display shows the speed of the vehicle.

Trip computer (10.25-inch)

The trip computer is a microcomputer-controlled driver information system that displays information related to driving.

i Information

Some driving information stored in the trip computer (for example Average Vehicle Speed) resets if the battery is disconnected.

Trip modes

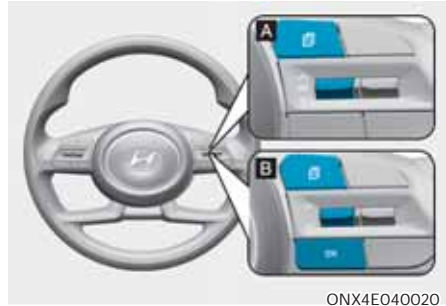
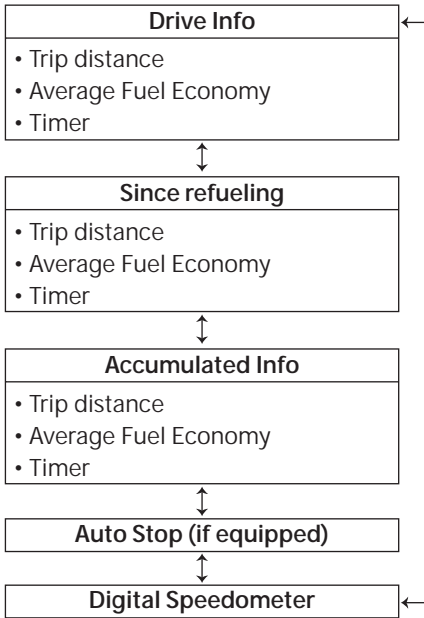

ONX4E040020

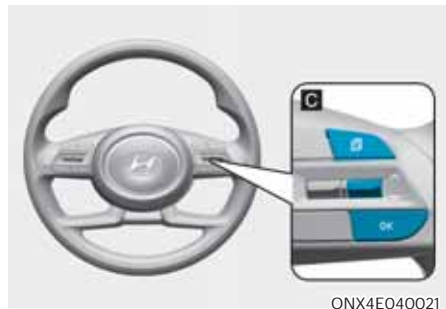

ONX4E040021

To change the trip mode, toggle the "∧, ∨" switch on the steering wheel.

- **Manual reset**
To clear the average fuel economy manually, press the OK switch on the steering wheel for more than 1 second when the Average Fuel Economy is displayed.
- **Automatic reset**
To automatically reset the average fuel economy, select between 'After Ignition' or 'After Refueling' from the Settings menu in the instrument cluster.
 - After Ignition: When the engine has been OFF for 3 minutes or longer the average fuel economy will reset automatically.
 - After Refueling: The average fuel economy will reset automatically after adding 6 liters (1.6 gallons) of fuel or more and after driving speed exceeds 1 km/h (1 mph).
- * For 10.25-inch instrument cluster, you can check the fuel economy in the center bottom of the instrument cluster.

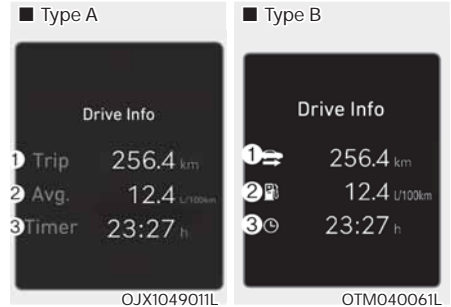

Drive info

Trip distance (1), average fuel economy (2), and total driving time (3) are displayed.

The information is combined for each ignition cycle. However, when the engine has been OFF for 3 minutes or longer the Drive Info screen will reset.

To reset manually, press the OK switch on the steering wheel for more than 1 second when 'Drive Info' is displayed.

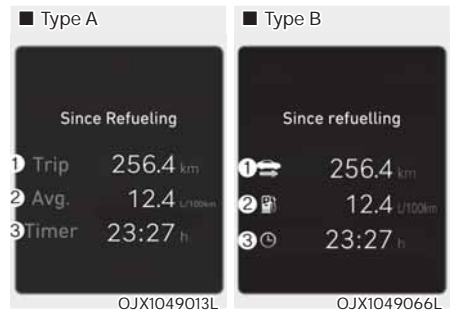

Since refuel(1)ing

Trip distance (1), average fuel economy (2), and total driving time (3) after the vehicle has been refueled are displayed.

To reset manually, press the OK switch on the steering wheel for more than 1 second when 'Since Refueling' is displayed.

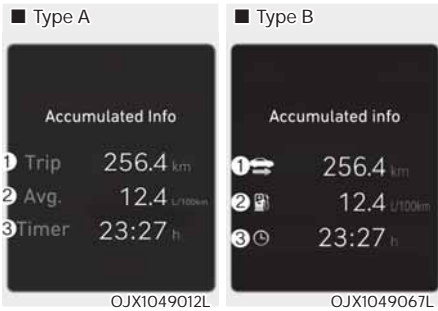

Accumulated info

Accumulated trip distance (1), average fuel economy (2), and total driving time (3) are displayed.

The information is accumulated starting from the last reset.

To reset manually, press the OK switch on the steering wheel for more than 1 second when 'Accumulated Info' is displayed.



Digital speedometer

Digital speedometer display shows the speed of the vehicle.



Auto stop (if equipped)

AUTO STOP display shows the elapsed time of engine stop by Idle Stop and Go system.

For more details, refer to "Idle Stop and Go (ISG)" section in chapter 6.

VEHICLE SETTINGS (INFOTAINMENT SYSTEM) (IF EQUIPPED)



Vehicle Settings in the infotainment system provides user options for a variety of settings including door lock/unlock features, convenience features, driver assistance settings, etc.

Vehicle Settings menu

- Driver Assistance
- Cluster
- Climate
- Seat
- Lights
- Door
- Convenience

The information provided may differ depending on which functions are applicable to your vehicle.



WARNING

Do not operate the Vehicle Settings while driving. This may cause distraction resulting in an accident.

Setting your vehicle



1. Press the SETUP button on the head unit of the infotainment system.



2. Select 'Vehicle' and change the setting of the features.

For detailed information, please refer to the infotainment system manual separately supplied.

5. Convenience Features

Accessing your vehicle	5-4
Remote key	5-4
Smart key	5-7
Immobilizer system	5-12
Door locks.....	5-13
Operating door locks from outside the vehicle.....	5-13
Operating door unlocks from inside the vehicle.....	5-15
Deadlocks	5-16
Auto door lock/unlock features.....	5-17
Child-protector rear door locks.....	5-17
Theft-alarm system.....	5-18
Rear Occupant Alert (ROA)	5-19
System setting	5-19
System operation	5-19
System precautions.....	5-19
Integrated memory system.....	5-21
Storing memory positions	5-21
Recalling memory positions.....	5-22
Resetting the system	5-22
Easy access function.....	5-23
Steering wheel	5-24
Electric Power Steering (EPS).....	5-24
Tilt / Telescopic steering.....	5-25
Horn.....	5-26
Mirrors	5-27
Inside rearview mirror	5-27
Outside rearview mirrors	5-28
Windows.....	5-31
Power windows	5-32
Panorama Sunroof	5-36
Power sunshade	5-36
Tilt open/close.....	5-37
Slide open/close.....	5-37
Automatic reversal	5-38
Resetting the sunroof	5-39
Sunroof open warning	5-40

Exterior features.....	5-41
Hood.....	5-41
Tailgate.....	5-42
Power tailgate operating conditions.....	5-44
Setting the power tailgate	5-48
Smart tailgate	5-50
Fuel filler door.....	5-52
Lighting.....	5-56
Exterior lights.....	5-56
High Beam Assist (HBA)	5-61
High Beam Assist settings	5-61
High Beam Assist operation	5-62
High Beam Assist malfunction and limitations	5-62
Interior lights	5-64
Interior lamp AUTO cut	5-64
Front lamps.....	5-64
Rear lamps	5-65
Vanity mirror lamp.....	5-65
Glove box lamp.....	5-65
Luggage compartment lamp	5-65
Welcome system	5-66
Wipers and washers.....	5-67
Windshield wipers.....	5-68
Front windshield washers.....	5-69
Rear window wiper and washer	5-70
Manual climate control system.....	5-71
Heating and air conditioning.....	5-72
System operation	5-76
System maintenance	5-77
Automatic climate control system.....	5-80
Automatic heating and air conditioning.....	5-81
Manual heating and air conditioning.....	5-82
Multi Air Mode	5-88
System operation	5-89
System maintenance	5-91
Windshield defrosting and defogging.....	5-93
Manual climate control system	5-93
Automatic climate control system	5-94
Rear window defroster	5-95

5. Convenience Features

Climate control additional features.....	5-96
Auto defogging system.....	5-96
Auto dehumidify.....	5-97
Recirculating air when washer fluid is used.....	5-98
Sunroof inside air recirculation.....	5-98
Auto. Controls That Use Climate Control Settings (for driver's seat).....	5-98
Recirculation Mode Plus.....	5-99
Storage compartment.....	5-100
Center console storage.....	5-100
Glove box.....	5-100
Luggage tray.....	5-100
Interior features.....	5-101
Cup holder.....	5-101
Sunvisor.....	5-102
Power outlet.....	5-102
USB charger.....	5-103
Wireless smart phone charging system.....	5-104
Clock.....	5-107
Coat hook.....	5-107
Floor mat anchor(s).....	5-107
Side curtain.....	5-108
Luggage net holder.....	5-109
Cargo security screen.....	5-109
Roof rack.....	5-111
Infotainment system.....	5-112
USB Port.....	5-112
Antenna.....	5-112
Steering wheel remote controls.....	5-112
Infotainment system.....	5-113
Voice recognition.....	5-113
Bluetooth® Wireless Technology.....	5-114
How vehicle radio works.....	5-114

ACCESSING YOUR VEHICLE

Remote key (if equipped)



Your HYUNDAI uses a remote key, which you can use to lock or unlock the driver and passenger doors or the tailgate.

1. Door Lock
2. Door Unlock
3. Tailgate Unlock

Locking

To lock :

1. Close all doors, engine hood and tailgate.
2. Press the Door Lock button (1) on the remote key.
3. The doors will lock. The hazard warning lights will blink. Also, the outside rearview mirror will fold, if 'Convenience → Welcome mirror/light → On door unlock' is selected from the User Settings mode on the LCD display. **For more details, refer to "LCD Display" in chapter 4.**
4. Make sure the doors are locked by checking the position of the door lock button inside the vehicle.

WARNING

Do not leave the keys in your vehicle with unsupervised children. Unattended children could place the key in the ignition switch and may operate power windows or other controls, or even make the vehicle move, which could result in serious injury or death.

Unlocking

To unlock:

1. Press the Door Unlock button (2) on the remote key.
2. The doors will unlock. The hazard warning lights will blink two times. Also, the outside rearview mirror will unfold, if 'Convenience → Welcome mirror/light → On door unlock' is selected from the User Settings mode on the LCD display. **For more details, refer to "LCD Display" in chapter 4.**

Information

After unlocking the doors, the doors will lock automatically after 30 seconds unless a door is opened.

Tailgate unlocking

To unlock:

1. Press the Tailgate Unlock button (3) on the remote key for more than one second.
2. The hazard warning lights will blink two times. Once the tailgate is opened and then closed, the tailgate will lock automatically.

i Information

- After unlocking the tailgate, the tailgate will lock automatically.
- The word “HOLD” is written on the button to inform you that you must press and hold the button for more than one second.

Start-up

For detailed information refer to “Key Ignition Switch” in chapter 6.

NOTICE

To prevent damaging the remote key:

- Keep the remote key away from water or any liquid and fire. If the inside of the remote key gets damp (due to drinks or moisture), or is heated, internal circuit may malfunction, excluding the car from the warranty.
- Avoid dropping or throwing the remote key.
- Protect the remote key from extreme temperatures.

Mechanical key



OPDE046003

If the remote key does not operate normally, you can lock or unlock the door by using the mechanical key.

To unfold the key, press the release button then the key will unfold automatically.

To fold the key, fold the key manually while pressing the release button.

NOTICE

Do not fold the key without pressing the release button. This may damage the key.

Remote key precautions

The remote key will not work if any of the following occur:

- The key is in the ignition switch.
- You exceed the operating distance limit (about 10 m [30 feet]).
- The remote key battery is weak.
- Other vehicles or objects may be blocking the signal.
- The weather is extremely cold.
- The remote key is close to a radio transmitter such as a radio station or an airport which can interfere with normal operation of the remote key.

When the remote key does not work correctly, open and close the door with the mechanical key. If you have a problem with the remote key, it is recommended that you contact an authorized HYUNDAI dealer.

If the remote key is in close proximity to your mobile phone, the signal could be blocked by your mobile phone's normal operational signals.

This is especially important when the phone is active such as making and receiving calls, text messaging, and/ or sending/receiving emails.

Avoid placing the remote key and your mobile phone in the same location and always try to maintain an adequate distance between the two devices.

i Information

Changes or modifications not expressly approved by the party responsible for compliance could void the user's authority to operate the equipment. If the keyless entry system is inoperative due to changes or modifications not expressly approved by the party responsible for compliance, it will not be covered by your manufacturer's vehicle warranty.

NOTICE

Keep the remote key away from electromagnetic materials that block electromagnetic waves to the key surface.

Battery replacement



Battery Type: CR2032

1. Insert a slim tool into the slot and gently pry open the cover.
2. Remove the old battery and insert the new battery. Make sure the battery position is correct.
3. Reinstall the rear cover of the remote key.

If you suspect your remote key might have sustained some damage, or you feel your remote key is not working correctly, it is recommended that you contact an authorized HYUNDAI dealer.

⚠ WARNING

This product contains a button battery. If swallowed, a lithium button battery can cause severe or fatal injuries within 2 hours. Keep batteries out of reach of children. If you think batteries may have been swallowed or placed inside any part of the body, seek immediate medical attention.

i Information



An inappropriately disposed battery can be harmful to the environment and human health. Dispose of the battery according to your local law(s) and regulation.

Smart key (if equipped)

■ Type A



OTM050228L

■ Type B



ONX4050138

■ Type C



ONX4050076L

Your HYUNDAI uses a smart key, which you can use to lock or unlock a door (and tailgate) and even start the engine even just carrying the key.

1. Door lock
2. Door unlock
3. Tailgate lock / unlock (Tailgate)
Tailgate open / close (Power tailgate)
4. Remote start (if equipped)

Locking your vehicle



ODN8059001

To lock :

1. Close all doors, engine hood and tailgate.
2. Carry the smart key.
3. Either press the door handle button or press the Door Lock button on the smart key.
4. The hazard warning lights will blink. Also, the outside rearview mirror will fold, if 'Convenience → Welcome mirror/light → On door unlock or On driver approach' is selected from the User Settings mode on the LCD display. **For more details, refer to "LCD Display" in chapter 4.**
5. Make sure the doors are locked by pulling the door outside handle.

i Information

The door handle button will only operate when the smart key is within 0.7~1 m (28~40 in.) from the outside door handle.

Even though you press the outside door handle button, the doors will not lock and the chime will sound for three seconds if any of the following occur:

- The Smart Key is in the vehicle.
- The Engine Start/Stop button is in ACC or ON position.
- Any door except the tailgate is open.



WARNING

Do not leave the Smart Key in your vehicle with unsupervised children. Unattended children could press the Engine Start/ Stop button and may operate power windows or other controls, or even make the vehicle move, which could result in serious injury or death.

Unlocking your vehicle



To unlock:

1. Carry the Smart Key.
2. Either press the door handle button or press the Door Unlock button on the smart key.
3. The doors will unlock. The hazard warning lights will blink two times. Also, the outside rearview mirror will unfold, if 'Convenience → Welcome mirror/light → On door unlock or On driver approach' is selected from the User Settings mode on the LCD display. **For more details, refer to "LCD Display" in chapter 4.**



Information

- **The door handle button will only operate when the smart key is within 0.7~1 m (28~40 in.) from the outside door handle. Other people can also open the doors without the smart key in possession.**
- **After unlocking the doors, the doors will lock automatically after 30 seconds unless a door is opened.**
- **The doors may lock or unlock if the touch sensor of the outer door handle is recognized while washing your car or due to heavy rain.**
- **To prevent unintentional door lock or unlock:**

Press the lock button on the smart key and immediately press the unlock button along with the lock button for more than 4 seconds. The doors will not lock or unlock even though the touch sensor is touched on the outside door handle.

To deactivate the function, press the door lock or unlock button on the smart key.

Opening the tailgate

To unlock:

1. Carry the smart key.
2. Either press the tailgate handle button or press the Tailgate Unlock button (3) on the smart key for more than one second.
3. The hazard warning lights will blink two times.

i Information

- **The Tailgate Unlock button (3) will only unlock the tailgate. It will not release the latch and open the tailgate automatically. If the Tailgate Unlock button is used, someone must still press the tailgate handle button to open the tailgate.**
- **After unlocking the tailgate, the tailgate will lock automatically after 30 seconds unless the tailgate is opened.**

Remotely starting vehicle (if equipped)

You can start the vehicle using the Remote Start button (4) on the smart key.

To start the vehicle remotely:

1. Press the door lock button on the smart key within 10 m (32 feet) from the vehicle.
2. Press the Remote Start button (4) for more than 2 seconds within 4 seconds after pressing the door lock button.
3. To turn off the remote start function, press the Remote Start button (4) once.

i Information

- **The vehicle must be in P (Park) for the remote start function to start.**
- **The engine turns off if you get on the vehicle without a registered smart key.**
- **The engine turns off if you do not get on the vehicle within 10 minutes after remotely starting the vehicle.**
- **The Remote Start button (4) may not operate if the smart key is not within 10 m (32 feet).**
- **The vehicle will not remotely start if the engine hood or tailgate is opened.**
- **Do not idle the engine for a long period.**

Start-up

You can start the vehicle without inserting the key.

For more details, refer to the “Engine Start/Stop Button” section in chapter 6.

i Information

If the smart key is not moved for some time, the detection function for smart key operation will pause. Lift the smart key to activate the detection again.

NOTICE

To prevent damaging the smart key:

- **Keep the smart key in a cool, dry place to avoid damage or malfunction. Exposure to moisture or high temperature may cause the internal circuit of the smart key to malfunction which may not be covered under warranty.**
- **Avoid dropping or throwing the smart key.**
- **Protect the smart key from extreme temperatures.**

Mechanical key

If the Smart Key does not operate normally, you can lock or unlock the driver's door by using the mechanical key.

To remove the mechanical key from the smart key FOB:



Press and hold the release button (1) and remove the mechanical key (2). Insert the mechanical key into the key hole on the door.

To reinstall the mechanical key, put the key into the hole and push it until a click sound is heard.

Loss of a smart key

A maximum of two smart keys can be registered to a single vehicle. If you happen to lose your smart key, it is recommended that you immediately take the vehicle and remaining key to your authorized HYUNDAI dealer or tow the vehicle, if necessary.

Smart key precautions

The smart key may not work if any of the following occur:

- The smart key is close to a radio transmitter such as a radio station, military area, police station, government offices, broadcasting stations, transmission towers, port or an airport which can interfere with normal operation of the transmitter.
- The smart key is near a mobile two way radio system or a mobile phone.
- The smart key is close to a metal product or coins.
- Another vehicle's smart key is being operated close to your vehicle.

In the following situations, the frequency band from the smart key may be mixed with a different frequency, which may cause smart key malfunction (engine operation, door lock function, etc.) or the working distance of smart key may change:

- The smart key is placed near the electronic systems (woofer, mobile phone, portable wired/wireless charger, electric heating device, electronic power bank, e-cigarettes, etc.).
- When you connect an external device to the multi-purpose socket or USB port and place it near the smart key, the smart key may not be recognized/work in some areas of the vehicle. In this case, try moving the smart key to another location to start the engine or press the start button directly with the smart key to start the engine.

If the smart key does not work correctly, open and close the door with the mechanical key. If you have a problem with the smart key, it is recommended to contact an authorized HYUNDAI dealer.

If the smart key is in close proximity to your mobile phone, the signal could be blocked by your mobile phone's normal operational signals. This is specifically relevant when the phone is active such as making and receiving calls, text messaging, and/or sending/receiving emails. When possible, avoid keeping the smart key and your mobile phone in the same location such as pants or jacket pocket in order to avoid interference between the two devices.

i Information

Changes or modifications not expressly approved by the party responsible for compliance could void the user's authority to operate the equipment. If the keyless entry system is inoperative due to changes or modifications not expressly approved by the party responsible for compliance, it will not be covered by your manufacturer's vehicle warranty.

NOTICE

- **Keep the smart key away from electromagnetic materials that blocks electromagnetic waves to the key surface.**
- **Always have the smart key with you when leaving the vehicle. If the smart key is left near the vehicle, the vehicle battery may be discharged.**

Battery replacement

If the Smart Key is not working properly, try replacing the battery with a new one.

Battery Type: CR2032

To replace the battery:



ODN8059266

Remove the smart key cover by turning the screwdriver clockwise by inserting the screwdriver (-) into the hole.

Battery Type: CR2032

To replace the battery:

1. Remove the mechanical key.
2. Use a slim tool to pry open the rear cover of the smart key.
3. Remove the old battery and insert the new battery. Make sure the battery position is correct.
4. Reinstall the rear cover of the smart key.

If you suspect your smart key might have sustained some damage, or you feel your smart key is not working correctly, it is recommended that you contact an authorized HYUNDAI dealer.

! WARNING

This product contains a button battery. If swallowed, a lithium button battery can cause severe or fatal injuries within 2 hours. Keep batteries out of reach of children. If you think batteries may have been swallowed or placed inside any part of the body, seek immediate medical attention.



Information



An inappropriately disposed battery can be harmful to the environment and human health. Dispose of the battery according to your local law(s) or regulations.

Immobilizer system

The immobilizer system helps protect your vehicle from theft. If an improperly coded key (or other device) is used, the engine's fuel system is disabled.

When the ignition switch or Engine Start/ Stop button is placed to the ON position, the immobilizer system indicator should come on briefly, then go off. If the indicator starts to blink, the system does not recognize the coding of the key.

Place the ignition switch or Engine Start/ Stop button to the LOCK/ OFF position, then place the ignition switch or Engine Start/Stop button to the ON position again.

The system may not recognize your key's coding if another immobilizer key or other metal object (for example, key chain) is near the key. The engine may not start because the metal may interrupt the transponder signal from transmitting normally.

If the system repeatedly does not recognize the coding of the key, it is recommended that you contact your HYUNDAI dealer.

Do not attempt to alter this system or add other devices to it. Electrical problems could result that may make your vehicle inoperable.

Disclaimer:

The system is designed in such a way that it makes vehicle theft difficult if its circuit and battery connection is uninterrupted.



WARNING

In order to prevent theft of your vehicle, do not leave spare keys anywhere in your vehicle. Your immobilizer password is a customer unique password and should be kept confidential.

NOTICE

The transponder in your key is an important part of the immobilizer system. It is designed to give years of trouble-free service, however you should avoid exposure to moisture, static electricity and rough handling. Immobilizer system malfunction could occur.

DOOR LOCKS

Operating door locks from outside the vehicle

Mechanical key



1. Pull out the door handle.
2. Press the lever (1) located inside the bottom part of the cover with a mechanical key or flat-head screwdriver.
3. Push out the cover (2) while pressing the lever.
4. Turn the mechanical key (3) toward the rear of the vehicle to unlock and toward the front of the vehicle to lock.

Once the doors are unlocked, they may be opened by pulling the door handle.

When closing the door, push the door by hand. Make sure that doors are closed securely.

i Information

- Be careful when locking the door by mechanical key operation, only the driver's door can be locked/unlocked.
- When all doors are locked with the mechanical key, lock all doors by using the central door lock switch inside the vehicle. Open the door using the driver's inner door handle, and then close the door and lock the driver's door with mechanical key operation.
- Refer to Chapter 5 "Operating door locks from inside the vehicle" to lock from inside the vehicle.

i Information

- When removing the cover, be careful not to lose cover and any scratches.
- When the key cover freezes and does not open, lightly tap or indirectly warm (hand temperature, etc.) it.
- Do not apply excessive force to the door and door handle. It may be damaged.

Remote key



To lock the doors, press the Door Lock button (1) on the remote key.

To unlock the doors, press the Door Unlock button (2) on the remote key.

Once the doors are unlocked, they may be opened by pulling the door handle.

When closing the door, push the door by hand. Make sure that doors are closed securely.

Smart key



To lock the doors, press the button on the outside door handle while carrying the smart key with you or press the door lock button on the smart key.

To unlock the doors, press the button on the outside door handle while carrying the smart key with you or press the door unlock button on the smart key.

Once the doors are unlocked, they may be opened by pulling the door handle.

When closing the door, push the door by hand. Make sure that doors are closed securely.

i Information

- **In cold and wet climates, door lock and door mechanisms may not work properly due to freezing conditions.**
- **If the door is locked/unlocked multiple times in rapid succession with either the vehicle key or door lock switch, the system may stop operating temporarily in order to protect the circuit and prevent damage to system components.**

Operating door unlocks from inside the vehicle

With the door inside handle



Driver door & Passenger door

If the inner door handle is pulled when the door is locked, the door will unlock and open.

Rear door

If the inner door handle is pulled once when the door is locked, the door will unlock. If the inner door handle is pulled once more, the door will open.

If any door is opened, the doors will not lock even though the central door lock switch is pressed.

i Information

If a power door lock ever fails to function while you are in the vehicle try one or more of the following techniques to exit:

- **Operate the door unlock feature repeatedly (both electronic and manual) while simultaneously pulling on the door handle.**
- **Operate the other door locks and handles.**
- **Lower a front window and use the mechanical key to unlock the door from outside.**

With the central door lock/unlock switch



- When pressing the (🔒) portion (1) on the switch, all vehicle doors will lock.
 - If any door is opened, the doors will not lock even though the lock button (1) of the central door lock switch is pressed.
- When pressing the (🔓) portion (2) on the switch, all vehicle doors will unlock.
- Doors indicating light (3)
When all vehicle doors are locked, the indicating lights on the driver's door and passenger's door will turn on. If any door is unlocked, it would go off.



WARNING

- The doors should always be fully closed and locked while the vehicle is in motion. If the doors are unlocked, the risk of being thrown from the vehicle in a crash is increased.
- Do not pull the inner door handle of the driver's or passenger's door while the vehicle is moving.



WARNING

Do not leave the elderly, children or animals unattended in your vehicle. An enclosed vehicle can become extremely hot, causing death or serious injury to the elderly, unattended children or animals who cannot escape from the vehicle. Children might operate features of the vehicle that could injure them, or they could encounter other harm, possibly from someone gaining entry to the vehicle.



WARNING

Always secure your vehicle.
Leaving your vehicle unlocked increases the potential risk to you or others from someone hiding in your vehicle.
To secure your vehicle, while depressing the brake, shift the gear to the P (Park) position (for automatic transmission), engage the parking brake, and place the ignition switch or Engine Start/Stop button in the LOCK/OFF position, close all windows, lock all doors, and always take the key with you.



CAUTION

Opening a door when something is approaching may cause damage or injury. Be careful when opening doors and watch for vehicles, motorcycles, bicycles or pedestrians approaching the vehicle in the path of the door.



WARNING

If you stay in the vehicle for a long time while the weather is very hot or cold, there are risks of injuries or danger to life. Do not lock the vehicle from the outside when someone is in the vehicle.

Deadlocks (if equipped)

Some vehicles are equipped with a deadlock system. Deadlocks prevent opening of a door from either inside or outside the vehicle once the deadlocks have been activated providing an additional measure of vehicle security.
To lock the vehicle using the deadlock function, the doors must be locked by using the remote key or smart key. To unlock the vehicle, the transmitter or smart key must be used again.

Auto door lock/unlock features *Impact sensing door unlock system*

All doors will be automatically unlocked when an impact causes the air bags to deploy.

Speed sensing door lock system (if equipped)

All doors will be automatically locked when vehicle speed exceeds 15 km/h (9 mph).

You can activate or deactivate the Auto Door Lock/Unlock features from the User Settings mode on the LCD display. **For more details, refer to “LCD Display” in chapter 4. If your vehicle is equipped with additional navigation, please refer to the infotainment system manual separately supplied.**

Child-protector rear door locks



The child safety lock is provided to help prevent children seated in the rear from accidentally opening the rear doors. The rear door safety locks should be used whenever children are in the vehicle.

The child safety lock is located on the edge of each rear door. When the child safety lock is in the lock position, the rear door will not open if the inner door handle is pulled.

To lock the child safety lock, insert a small flat blade tool (like a screwdriver or similar) (1) into the slot and turn it to the lock position as shown.

To allow a rear door to be opened from inside the vehicle (2), unlock the child safety lock.

WARNING

If children accidentally open the rear doors while the vehicle is in motion, they could fall out of the vehicle. The rear door safety locks should always be used whenever children are in the vehicle.

THEFT-ALARM SYSTEM

This system helps to protect your vehicle and valuables. The horn will sound and the hazard warning lights will blink continuously if any of the following occur:

- A door is opened without using the remote key or smart key.
- The tailgate is opened without using the remote key or smart key.
- The engine hood is opened.

The alarm continues for 30 seconds, then the system resets. To turn off the alarm, unlock the doors with the remote key or smart key.

The Theft Alarm System automatically sets 30 seconds after you lock the doors and the tailgate. For the system to activate, you must lock the doors and the tailgate from outside the vehicle with the remote key or smart key or by pressing the button on the outside of the door handles with the smart key in your possession.

The hazard warning lights will blink and the chime will sound once to indicate the system is armed.

Once the security system is set, opening any door, the tailgate, or the hood without using the remote key or smart key will cause the alarm to activate.

The Theft Alarm System will not set if the hood, the tailgate, or any door is not fully closed. If the system will not set, check the hood, the tailgate, or the doors are fully closed.

Do not attempt to alter this system or add other devices to it.

i Information

- **Do not lock the doors until all passengers have left the vehicle. If the remaining passenger leaves the vehicle when the system is armed, the alarm will be activated.**

- **If the vehicle is not disarmed with the remote key or smart key, open the doors by using the mechanical key and place the ignition switch in the ON position (for remote key) or start the engine (for smart key) and wait for 30 seconds.**
- **When the system is disarmed but a door or tailgate is not opened within 30 seconds, the system will be rearmed.**

⚠ WARNING

We recommend that you receive the services related to the burglar alarm system by the authorized HYUNDAI dealer. Arbitrary modification or alteration of the burglar alarm system may result in a malfunction. A failure caused by arbitrary alteration or modification is not covered by the warranty.

i Information



Vehicles equipped with a theft alarm system will have a label attached to the vehicle with the following words:

1. **WARNING**
2. **SECURITY SYSTEM**

Disclaimer:

The system is designed in such a way that it makes vehicle theft difficult if its circuit and battery connection is uninterrupted.

REAR OCCUPANT ALERT (ROA) (IF EQUIPPED)

Rear Occupant Alert is provided to help prevent the driver from leaving the vehicle with the rear passenger left in the vehicle.

System setting

To use Rear Occupant Alert, it must be enabled from the Settings menu in the infotainment system screen. Select:

- Setup → Vehicle Settings → Convenience → Rear Occupant Alert

For more details, refer to the separately supplied Infotainment manual with your vehicle.

System operation

- **First alert**
When you open the front door after opening and closing the rear door and turning off the engine, the 'Check rear seats' warning message appears on the cluster.
- **Second alert**
After the first alert, the second alert operates when any movement is detected in the vehicle after the driver's door is closed and all the doors are locked. The horn will sound for approximately 25 seconds. If the system continues to detect a movement, the alert operates up to 8 times.
Unlock the doors with the smart key to stop the alert.
- The system detects movement in the vehicle for 8 hours after the door is locked.
- The second alert is activated only after the prior activation of the first alert.

System precautions

- Make sure that all the windows are closed. If the window is open, the alert may operate by the sensor detecting an unintended movement (for example, wind or bugs).



If you do not want to use Rear Occupant Alert, press the OK button on the steering wheel when the first alert is displayed on the cluster. Doing so will deactivate the second alert one time.

- An alert can occur if there is an impact on the roof.
- If boxes or objects are stacked in the vehicle, the system may not detect the boxes or objects. Or, the alert may operate if the boxes or objects fall off.
- The sensor may not operate normally if the sensor is obscured by foreign substances.
- The alert may operate if movement in the driver or passenger seat is detected.
- The alert may operate with the doors locked due to car wash or surrounding vibration or noise.
- If the vehicle is started remotely (if equipped with Remote Start), inside movement detection will stop.



WARNING

Even if your vehicle is equipped with Rear Occupant Alert, always make sure to check the rear seat before you leave the vehicle.

Rear Occupant Alert may not operate when:

- Movement does not continue for a certain period of time or the movement is small.
- The rear passenger is covered with an object such as a blanket.
- Always be cautious of the passenger's safety as the detection function and second alert may not operate depending on the surrounding environment and certain conditions.

INTEGRATED MEMORY SYSTEM (IF EQUIPPED)



©NX4050007

Integrated Memory System for the driver's seat is provided to store and recall the following memory settings with a simple button operation.

- Driver's seat position



WARNING

Never attempt to operate the integrated memory system while the vehicle is moving.

This could result in loss of control, and an accident causing death, serious injury, or property damage.

i Information

- If the battery is disconnected, the memory settings will be erased.
- If integrated memory system does not operate normally, we recommend that you have the system inspected by an authorized HYUNDAI dealer.

Storing memory positions

1. The ignition switch or Engine Start/ Stop button is in ON position and the vehicle speed is below 3 km/h.
2. Adjust the driver's seat position.
3. Press the SET button. The system will beep once and notify you 'Press button to save settings' on the cluster LCD display.
4. Press one of the memory buttons (1 or 2) within 4 seconds. The system will beep twice when the memory has been successfully stored.
5. 'Driver 1 (or 2) settings saved' will appear on the cluster LCD display. The message appears only for the driver's seat position memory setting.

Recalling memory positions

1. The Engine Start/Stop button is pressed to the ON position.
2. Press the desired memory button (1 or 2). The system will beep once, and then the driver's seat position and instrument panel illumination intensity will automatically adjust to the stored positions.
3. 'Driver 1 (or 2) settings applied' will appear on the cluster LCD display.

Information

- **If you press the SET button or the corresponding button which the setting is being recalled, the setting will temporarily deactivate. If you press the other buttons, the setting of the pressed button will activate.**
For example, if you press the SET button or number 1 button with the number 1 setting in operation, the setting will temporarily deactivate. If you press the number 2 button, the number 2 setting will activate.
- **If you adjust the seat while recalling the stored positions, the preset settings will become ineffective.**

Resetting the system

Take the following procedures to reset integrated memory system, when it does not operate properly.

Resetting integrated memory system

1. Stop the vehicle and open the driver's door with the Engine Start/Stop button in the ON position and the vehicle shifted to P (Park).
2. Adjust the driver's seat and seatback to the foremost position.
3. Press the SET button and push forward the driver's seat switch simultaneously (about two seconds).
4. Release the SET button and the driver's seat switch when a beep sounds.

While resetting integrated memory system

1. Resetting starts with a notification sound.
2. The driver's seat and seatback is adjusted to the rearward position with the notification sound.
3. The driver's seat and seatback is re-adjusted to the default position (central position) with the notification sound.

However, in the following cases, the resetting procedure and the notification sound may stop.

- The memory button is pressed.
- The seat control switch is operated.
- The gear is shifted out of P (Park).
- The driving speed exceeds 3 km/h (2 mph).
- The driver's door is closed.

NOTICE

- While integrated memory system is being reset, if the resetting and notification sound stops incompletely, restart the resetting procedure again.
- Make sure that there is no objects around the driver's seat in advance of resetting the integrated memory system.

Easy access function

The system will move the driver's seat automatically as follows:

- With remote key
 - It will move the driver's seat rearward when the ignition key is removed.
 - It will move the driver's seat forward when the ignition key is inserted.
- With smart key
 - It will move the driver's seat rearward when the Engine Start/Stop button is pressed to the OFF position.
 - It will move the driver's seat forward when the Engine Start/Stop button is pressed to the ACC or START position.

You can activate or deactivate the Easy Access Function from the User Settings mode on the LCD display. 'Convenience → Seat Easy Access → Off/Normal/Extended'.

For more details, refer to "LCD Display" In chapter 4.

**CAUTION**

Driver should be cautious when using this function to ensure no injury to passenger or child on the back seat. In case of emergency the driver has to stop movement of front seat (when easy access feature is activated) by pressing SET button or any of the driver seat control switches.

STEERING WHEEL

Electric Power Steering (EPS)

The system assists you with steering the vehicle. If the vehicle is turned off or if the power steering system becomes inoperative, you may still steer the vehicle, but it will require increased steering effort.

Should you notice any change in the effort required to steer during normal vehicle operation, we recommend that you have the system checked by an authorized HYUNDAI dealer.



CAUTION

If Electric Power Steering does not operate normally, the  warning light and the message 'Check motor driven power steering' will illuminate on the instrument cluster. You may steer the vehicle, but it will require increased steering efforts. We recommend that you take your vehicle to an authorized HYUNDAI dealer or to a service station and have the system checked as soon as possible.



Information

The following symptoms may occur during normal vehicle operation:

- The steering effort may be high immediately after placing the ignition switch or Engine Start/Stop button to the ON position.
This happens as the system performs the EPS system diagnostics. When the diagnostics are completed, the steering wheel effort will return to its normal condition.
- When the battery voltage is low, you might have to put more steering effort. However, it is a temporary condition so that it will return to normal condition after charging the battery.
- A click noise may be heard from the EPS relay after the ignition switch or Engine Start/Stop button is in the ON or LOCK/OFF position.
- Motor noise may be heard when the vehicle is at a stop or at a low driving speed.
- When you operate the steering wheel in low temperatures, abnormal noise may occur. If the temperature rises, the noise will disappear. This is a normal condition.
- When an error is detected from EPS, the steering effort assist function will not be activated in order to prevent fatal accidents. Instrument cluster warning lights may be on or the steering effort may be high. If these symptoms occur, drive the vehicle to a safe area as soon as it is safe to do so. We recommend that you have the system checked by an authorized HYUNDAI dealer as soon as possible.

Tilt / Telescopic steering

When adjusting the steering wheel to a comfortable position, adjust the steering wheel so that it points toward your chest, not toward your face. Make sure you can see the instrument cluster warning lights and gauges. After adjusting, push the steering wheel both up and down to be certain it is locked in position.

Always adjust the position of the steering wheel before driving.

WARNING

NEVER adjust the steering wheel while driving. This may cause loss of vehicle control resulting in an accident.

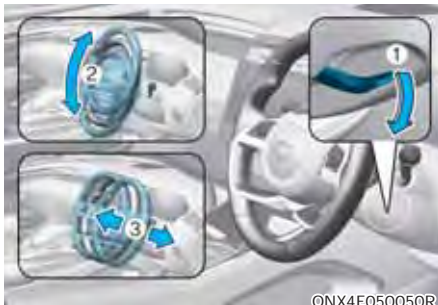

To adjust the steering wheel angle and height:

1. Pull down the lock-release lever (1).
2. Adjust the steering wheel to the desired angle (2) and distance forward/back (3).
3. Pull up the lock-release lever to lock the steering wheel in place.

CAUTION

While adjusting the steering wheel height, please do not push or pull it hard since the fixture can be damaged.

Information

Sometimes the lock release lever may not engage completely. This may occur when the gears of the locking mechanism do not completely mesh. If this occurs, pull down on the lock-release lever, readjust the steering wheel again, and then pull back up on the release lever to lock the steering wheel in place.

Horn



OCN7050016

To sound the horn, press the area indicated by the horn symbol on your steering wheel (see illustration). The horn will operate only when this area is pressed.

NOTICE

Do not strike the horn severely to operate it, or hit it with your fist. Do not press on the horn with a sharp-pointed object.

MIRRORS

Inside rearview mirror

Before driving your vehicle, check to see that your inside rearview mirror is properly positioned. Adjust the rearview mirror so that the view through the rear window is properly centered.

WARNING

Make sure your line of sight is not obstructed. Do not place objects in the rear seat, cargo area, or behind the rear headrests which could interfere with your vision through the rear window.

WARNING

To prevent serious injury during an accident or deployment of the air bag, do not modify the rearview mirror and do not install a wide mirror.

WARNING

NEVER adjust the mirror while driving. This may cause loss of vehicle control resulting in an accident.

NOTICE

When cleaning the mirror, use a paper towel or similar material dampened with glass cleaner. Do not spray glass cleaner directly on the mirror as this may cause the liquid cleaner to enter the mirror housing.

Day/night rearview mirror (if equipped)



[A]: Day, [B]: Night

Make this adjustment before you start driving and while the day/night lever is in the day position.

Pull the day/night lever towards you to reduce glare from the headlamps of the vehicles behind you during night driving. Remember that you lose some rearview clarity in the night position.

**Electric Chromic Mirror (ECM)
(if equipped)**

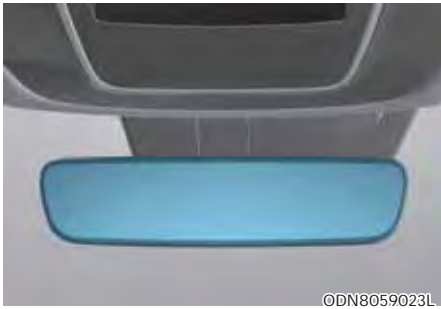

The electric rearview mirror automatically controls the glare from the headlamp of the vehicle behind you in nighttime or low light driving conditions. When the engine is running, the glare is automatically controlled by the sensor mounted in the rearview mirror. The sensor detects the light level around the vehicle, and automatically adjusts to control the headlamp glare from vehicles behind you. Whenever the the gear is shifted to R (Reverse), the mirror will automatically go to the brightest setting in order to improve the driver's view behind the vehicle.

Outside rearview mirrors



Your vehicle is equipped with both left-hand and right-hand outside rearview mirrors. The mirrors can be adjusted remotely with the mirror adjustment control switch. The outside rearview mirrors can be folded to help prevent damage when going through an automatic car wash or when passing through a narrow street. The left and right outside rearview mirror are convex. Objects seen in the mirror are closer than they appear. Use the inside rear view mirror or look back directly to determine the actual distance of other vehicles prior to changing lanes. Make sure to adjust the outside rearview mirrors to your desired position before you begin driving.



WARNING

Do not adjust or fold the outside rearview mirrors while driving. This may cause loss of vehicle control resulting in an accident.

NOTICE

- Do not scrape ice off the mirror face; this may damage the surface of the glass.
- If the mirror is jammed with ice, do not adjust the mirror by force. Use an approved de-icer (not radiator antifreeze) spray, or a sponge or soft cloth with very warm water, or move the vehicle to a warm place and allow the ice to melt.
- Do not clean the mirror with harsh abrasives, fuel or other petroleum based cleaning products.

Adjusting the rearview mirrors



1. Move the lever (1) either to the L (left side) or R (right side) to select the rearview mirror you would like to adjust.
2. Use the mirror adjustment control (2) to position the selected mirror up, down, left or right.
3. After adjustment, move the lever (1) to the middle to prevent inadvertent adjustment.

NOTICE

- The mirrors stop moving when they reach the maximum adjusting angles, but the motor continues to operate while the switch is pressed. Do not press the switch longer than necessary, because this can damage the motor.
- Do not attempt to adjust the rearview mirrors by hand, because this can damage the motor.

Folding the outside rearview mirror



Manual type

To fold the outside rearview mirror, grasp the housing of the mirror and then fold it toward the rear of the vehicle.



Electric type (if equipped)

The outside rearview mirror can be folded or unfolded by pressing the switch.

- If 'Convenience → Welcome mirror/light → On door unlock' is selected in the User Settings mode on the LCD display, the outside mirror will fold or unfold automatically as follows:
 - The mirror will fold or unfold when the door is locked or unlocked by the remote key or smart key.
 - The mirror will fold or unfold when the door is locked or unlocked by the button on the outside door handle.
- If 'Convenience → Welcome mirror/light → On door unlock' and 'Convenience → Welcome mirror/light → On driver approach' is selected in the User Settings mode on the LCD display, the outside mirror will unfold automatically when you approach the vehicle (all doors closed and locked) with a remote key or smart key in possession.

NOTICE

The electric type outside rearview mirror operates even though the ignition switch or Engine Start/Stop button is in the LOCK/OFF position. However, to prevent unnecessary battery discharge, do not adjust the mirrors longer than necessary while the engine is not running.

NOTICE

Do not fold the electric type outside rearview mirror by hand. It could cause motor failure.

WINDOWS

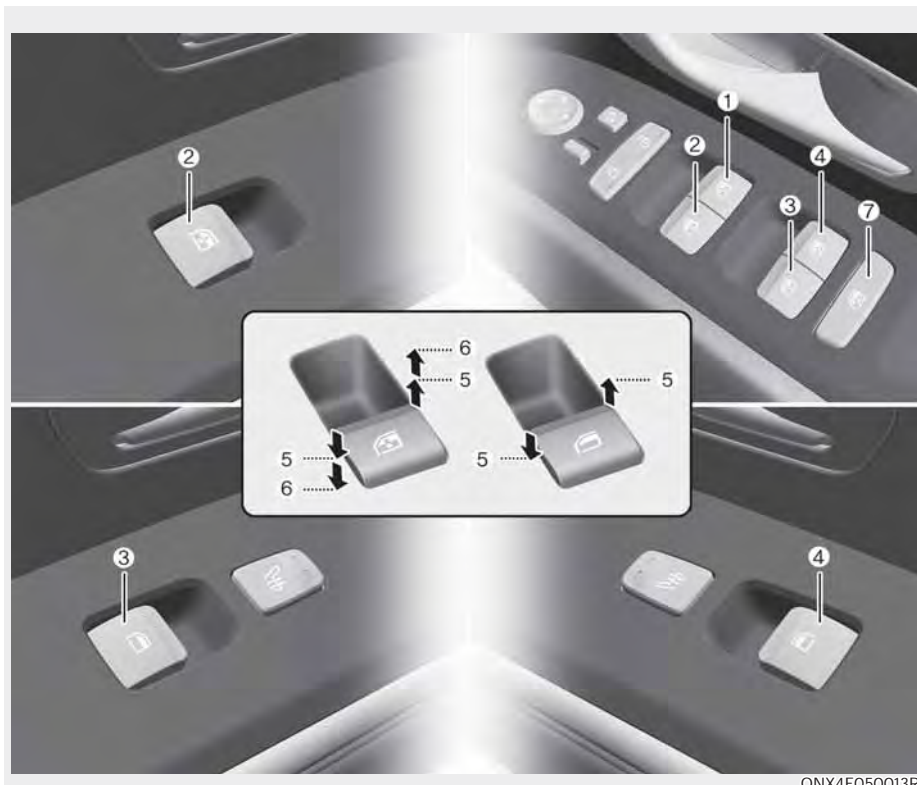

ONX4E050013R

- (1) Driver's door power window switch
- (2) Front passenger's door power window switch
- (3) Rear door (left) power window switch
- (4) Rear door (right) power window switch

- (5) Window opening and closing
- (6) Automatic power window*
- (7) Power window lock switch

* : if equipped

Power windows

The ignition switch or Engine Start/Stop button must be in the ON position to be able to raise or lower the windows. Each door has a Power Window switch to control that door's window. The driver has a Power Window Lock switch which can block the operation of rear passenger windows. The power windows will operate for approximately 3 minutes after the ignition switch or Engine Start/Stop button is placed in the ACC or LOCK/OFF position. However, if the front doors are opened, the Power Windows cannot be operated even within the 3 minutes period.

i Information

- **In cold and wet climates, power window may not work properly due to freezing conditions.**
- **While driving with the rear windows down or with the sunroof (if equipped) opened (or partially opened), your vehicle may demonstrate a wind buffeting or pulsation noise. This noise is normal and can be reduced or eliminated by taking the following actions. If the noise occurs with one or both of the rear windows down, partially lower both front windows approximately 2.5 cm (1 inch). If you experience the noise with the sunroof open, slightly close the sunroof.**

Window opening and closing



To open:

Press the window switch down to the first detent position (5). Release the switch when you want the window to stop.

To close:

Pull the window switch up to the first detent position (5). Release the window switch when you want the window to stop.

Auto down window (if equipped)

Pressing or pulling up the power window switch momentarily to the second detent position (6) completely lowers the window even when the switch is released.

To stop the window at the desired position while the window is in operation, pull up or press down and release the switch.

Auto up/down window (if equipped)

Pressing or pulling up the power window switch momentarily to the second detent position (6) completely lowers or lifts the window even when the switch is released. To stop the window at the desired position while the window is in operation, pull up or press down and release the switch.

Resetting the power windows

If the power windows do not operate normally, the automatic power window system must be reset as follows:

1. Press the ignition switch or Engine Start/Stop button to the ON position.
2. Close the window and continue pulling up on the power window switch for at least one second.

If the power windows do not operate properly after resetting, we recommend that the system be inspected by an authorized HYUNDAI dealer.



WARNING

The automatic reverse feature doesn't activate while resetting power window system. Make sure body parts or other objects are safely out of the way before closing the windows to avoid injuries or vehicle damage.

Automatic reverse (if equipped)



If a window senses any obstacle while it is closing automatically, it will stop and lower approximately 30 cm (12 in.) to allow the object to be cleared.

If the window detects the resistance while the power window switch is pulled up continuously, the window will stop upward movement then lower approximately 2.5 cm (1 in.).

If the power window switch is pulled up continuously again within 5 seconds after the window is lowered by the automatic window reverse feature, the automatic window reverse will not operate.



Information

The automatic reverse feature is only active when the “Auto Up” feature is used by fully pulling up the switch to the second detent.

NOTICE

Do not install any accessories on the windows. The automatic reverse feature may not operate.

⚠ WARNING

Make sure body parts or other objects are safely out of the way before closing the windows to avoid injuries or vehicle damage.

Objects less than 4 mm (0.16 in.) in diameter caught between the window glass and the upper window channel may not be detected by the automatic reverse window and the window will not stop and reverse direction.

Power window lock button



The driver can disable the power window switches on the rear passenger doors by pressing the power window lock button. When the power window lock button is pressed:

- The driver's master control can operate all the power windows.
 - The front passenger's control can operate the front passenger's power window.
 - The rear passenger's control cannot operate the rear passengers' power window.
- * If the power window lock button is operated, rear passenger cannot open the rear door.

⚠ WARNING

Do not allow children to play with the power windows. Keep the driver's door power window lock button in the LOCK position. Serious injury or death can result from unintentional window operation by a child.

NOTICE

- To prevent possible damage to the power window system, do not open or close two windows or more at the same time. This will also ensure the longevity of the fuse.
- Never try to operate the main switch on the driver's door and the individual door window switch in opposite directions at the same time. If this is done, the window will stop and cannot be opened or closed.

Remote window opening/closing function (if equipped)



ONX4EPH051004L

You can still control the window movement with the engine turned off.

- Press the Door Lock button (1) for more than 3 seconds. The window moves up, as long as you press the door lock button. The window movement stops, when you release the door lock button.
- Press the Door Unlock button (2) for more than 3 seconds. The window moves down after the doors are unlocked, as long as you press the door unlock button. The window movement stops, when you release the door lock button.

i Information

- The remote window closing function may abruptly stop when you move away from your vehicle during operation. Stay in close proximity from your vehicle, while monitoring the window movement.
- One of the windows may stop operating, when the window is interrupted by certain force. However, the other windows will keep operating. Thus, you should make sure that all windows are closed.
- The remote window closing function is operated on the window equipped with an automatic power window.

PANORAMA SUNROOF (IF EQUIPPED)

If your vehicle is equipped with a sunroof, you can slide or tilt your sunroof with the sunroof switch located on the overhead console.



The sunroof can only be operated when the ignition switch or Engine Start/Stop button is in the ON or START position.

The sunroof can be operated for approximately 3 minutes after the ignition switch or Engine Start/Stop button is in the ACC or OFF position.

However, if the front door is open, the sunroof cannot be operated even within the 3 minute period.

WARNING

- **Adjust the sunroof or sunshade when your vehicle stops.** This could result in loss of control and an accident that may cause injury, or property damage.
- **Do not leave the engine running and the key in your vehicle with unsupervised children.** Unattended children could operate the sunroof, which could result in serious injury.
- **Do not sit on the top of the vehicle.** It may cause injury or vehicle damage.

NOTICE

Do not operate the sunroof when roof bars are installed on the vehicle or when there is luggage on the roof.

Power sunshade



Use the power sunshade to block direct sunlight coming through the sunroof glass.

- Push the sunroof switch rearward to the first detent position, the power sunshade automatically slides open.
- Push the sunroof switch forward to the first detent position, the power sunshade automatically closes. However, if the sunroof glass is open, the glass will close first.

To stop the sunshade at any point, push the sunroof switch in any direction.

NOTICE

Do not pull or push the power sunshade by hand as such action may damage the power sunshade or cause it to malfunction.

Information

Wrinkles formed on the power sunshades are normal due to material characteristic.

Tilt open/close



- Push the sunroof switch upward, the sunroof glass tilts open. However, if the power sunshade is closed, the sunshade will open first.
- Push the sunroof switch upward or forward when the sunroof glass is tilt opened, the sunroof glass automatically closes.

To stop the sunroof movement at any point, push the sunroof switch in any direction.

Slide open/close



- Push the sunroof switch rearward to the first detent position, the sunroof glass opens. However, if the power sunshade is closed, the power sunshade will open first.
Push the sunroof switch forward to the first detent position, the sunroof glass closes. However, if the sunroof glass is closed, the power sunshade will close.
- Push the sunroof switch forward or rearward to the second detent position, the power sunshade and sunroof glass operate automatically (auto slide feature).

To stop the sunroof movement at any point, push the sunroof switch in any direction.

Automatic reversal

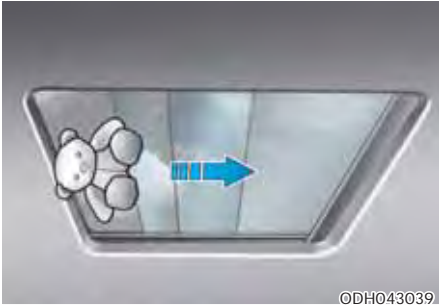

If the power sunshade or sunroof glass senses any obstacle while it is closing automatically, it will reverse direction then stop at a certain position.

The auto reverse function may not work if an object thin or soft is caught between the sliding power sunshade or sunroof glass and sunroof sash.

WARNING

- **Make sure heads, hands, arms or any other body parts or objects are out of the way before operating the sunroof. Body parts or objects may get caught causing injuries or vehicle damage.**
- **Never deliberately use your body parts to test the automatic reversal function. The power sunshade or sunroof glass may reverse direction, but there is a risk of injury.**

NOTICE

- **Do not continue to push the sunroof switch after the sunroof is fully opened, closed, or tilted. Damage to the sunroof motor could occur.**
- **Continuous operations such as slide open/close, tilt open/close, etc. may cause the motor or sunroof system to malfunction.**
- **Regularly remove any accumulated dust on the sunroof rail.**
- **Dust accumulated between the sunroof and roof panel can make noise. Open the sunroof and remove dust regularly using a clean cloth.**
- **Do not try to open the sunroof when the temperature is below freezing or when the sunroof is covered with snow or ice. The sunroof may not work properly and may break if opened by force.**
- **Do not open or drive with the sunroof glass open immediately after rain or washing the vehicle. Water may wet the interior of the vehicle.**
- **Do not extend any luggage outside the sunroof while driving. Vehicle damage may occur if the vehicle suddenly stops.**

WARNING

Do not extend your head, arms, body parts or objects outside the sunroof while driving. Injuries may occur if the vehicle suddenly stops.

Resetting the sunroof



In some circumstances resetting the sunroof operation may need to be performed. Some instances where resetting the sunroof may be required include:

- When the 12-volt battery is either disconnected or discharged
- When the sunroof fuse is replaced
- If the sunroof one-touch AUTO OPEN/CLOSE operation is not functioning properly

Sunroof resetting procedure:

1. It is recommended to perform the reset procedure with the vehicle engine running. Start the vehicle in P (Park).
2. Make sure the power sunshade and sunroof glass are in the fully closed position. If the power sunshade and sunroof glass are open, push the switch forward until the power sunshade and sunroof glass are fully closed.
3. Release the switch when the power sunshade and sunroof glass are fully closed.
4. Push the switch forward until the power sunshade and sunroof glass move slightly. Then release the switch.

5. Push the switch forward until the power sunshade and sunroof glass move slightly. Then release the switch.
6. Once again push and hold the sunroof switch forward until the power sunshade and sunroof glass slide open and close. Do not release the switch until the operation is completed. If you release the switch during operation, start the procedure again from step 2.

Information

If the sunroof does not reset when the vehicle battery is disconnected or discharged, or the sunroof fuse is blown, the sunroof may not operate normally.

Sunroof open warning



If the driver turns off the engine when the sunroof is not fully closed, the warning chime will sound for several seconds and the sunroof open warning will appear on the cluster LCD display. Close the sunroof securely when leaving your vehicle.



CAUTION

Make sure the sunroof is closed fully when leaving your vehicle.

If the sunroof is left open, rain or snow may wet the interior of the vehicle.

Also, leaving the sunroof open when the vehicle is unattended may invite theft.

EXTERIOR FEATURES

Hood

Opening the hood



ONX4E050055R

1. Park the vehicle and set the parking brake.
2. Pull the release lever to unlatch the hood. The hood should pop open slightly.



ONX4050021

3. Go to the front of the vehicle, raise the hood slightly, push up the secondary hood release lever (1) inside of the hood center and lift the hood (2).



ONX4050022

4. Pull out the stay rod.
5. Hold the hood opened with the stay rod (3).

WARNING

- **Grasp the stay rod in the area wrapped in rubber. The rubber will help prevent you from being burned by hot metal when the engine is hot.**
- **The stay rod must be inserted completely into the hole provided whenever you inspect the engine compartment. This will prevent the hood from falling and possibly injuring you.**

Closing the hood

1. Before closing the hood, check in and around the engine compartment to ensure the following:
 - Any tools or other loose objects are removed from the engine room area or hood opening area
 - All glove, rags, or other combustible material is removed from the engine compartment
 - All filler caps are tightly and correctly installed
2. Return the support rod to its clip to prevent it from rattling.
3. Lower the hood until it is about 30 cm (12in.) above the closed position and let it drop. Make sure that it locks into place.
4. Check that the hood has engaged properly. If the hood can be raised slightly, it is not properly engaged. Open it again and close it with a little more force.



WARNING

- **Before closing the hood, ensure all obstructions are removed from around the hood opening.**
- **Always double check to be sure that the hood is firmly latched before driving away. Check there is no hood open warning light or message displayed on the instrument cluster. Driving with the hood opened may cause a total loss of visibility, which might result in an accident.**
- **Do not move the vehicle with the hood in the raised position, as vision is obstructed, which might result in an accident, and the hood could fall or be damaged.**

Tailgate

Opening the tailgate



Make sure the vehicle is in P (Park) and set the parking brake.

Then do one of the following:

1. Unlock all doors with the Door Unlock button on your remote key or smart key. Press the tailgate handle button and open the tailgate.
2. Press and hold the Tailgate Unlock button on the remote key or smart key. Press the tailgate handle button and open the tailgate.
3. With the remote key or smart key in your possession, press the tailgate handle button and open the tailgate.

Closing the tailgate



Lower the tailgate lid and press down until it locks. To be sure the tailgate lid is securely fastened, always check by trying to pull it up again without pressing the tailgate handle button.

WARNING

Always keep the tailgate lid completely closed while the vehicle is in motion. If it is left open or ajar, poisonous exhaust gases containing carbon monoxide (CO) may enter the vehicle and serious illness or death may result.

NOTICE

To prevent damage to the tailgate lift cylinders and the attached hardware, always close the tailgate before driving.

Information

In cold and wet climates, tailgate lock and tailgate mechanisms may not work properly due to freezing conditions.

WARNING



Do not hold the part (gas lifter) that supports the tailgate. Be aware that the deformation of the part may cause vehicle damage and a risk of injury.

WARNING

- NEVER allow anyone to occupy the luggage compartment of the vehicle at any time. If the tailgate is partially or totally latched and the person is unable to get out, serious injury or death could occur due to lack of ventilation, exhaust fumes and rapid heat build-up, or because of exposure to cold weather conditions. The luggage compartment is also a highly dangerous location in the event of a crash because it is not a protected occupant space but is a part of the vehicle's crush zone.
- Your vehicle should be kept locked and keys should be kept out of the reach of children. Parents should teach their children about the dangers of playing in luggage compartments.

Emergency tailgate safety release



Your vehicle is equipped with the emergency tailgate safety release lever located on the bottom of the tailgate. When someone is inadvertently locked in the luggage compartment, the tailgate can be opened by moving the lever in the direction of the arrow and pushing the tailgate open.

WARNING

- For emergencies, be fully aware of the location of the emergency tailgate safety release lever in the vehicle and how to open the tailgate if you are accidentally locked in the luggage compartment.
- No one should be allowed to occupy the luggage compartment of the vehicle at any time. The luggage compartment is a very dangerous location in the event of a crash.
- Use the release lever for emergencies only. Use with extreme caution, especially while the vehicle is in motion.

Power tailgate operating conditions

The power tailgate operates when the gear is in P (Park) with the engine running. However, the power tailgate will operate regardless of the gear position when the engine is off. Also, the tailgate can be opened only when vehicle speed is below 3 km/h (1.8 mph).

For safety, before attempting to open or close the tailgate, make sure the vehicle is in P (Park).

WARNING

- **Never leave children or animals unattended in your vehicle. Children may operate the power tailgate. Doing so can result in injury to themselves or others and can damage the vehicle.**



Make sure that there are no people or objects in the path of the power tailgate or smart tailgate prior to use. Serious injury, damage to the vehicle or damage to surrounding objects (for example, walls, ceilings, vehicles, etc.) may result if contact with the tailgate occurs.

NOTICE

- Do not close or open the tailgate manually. This may cause damage to the power tailgate. If it is necessary to close or open the tailgate manually when the battery is discharged or disconnected, do not apply excessive force.
- Do not operate the power tailgate more than 10 times continuously when the engine is not running. Use the power tailgate with the engine running when the power tailgate is used repeatedly to prevent battery discharge.
- Do not leave the power tailgate open for a long period of time. This may drain the battery.
- Do not apply excessive force when the power tailgate is operating. Doing so could result in vehicle damage.



Do not grab or hold on to the tailgate support struts at any time. Damage to the tailgate support struts could result. Deformation of the tailgate support struts may cause vehicle damage and personal injury may occur.

- Do not modify or repair any part of the power tailgate by yourself. This must be done by an authorized HYUNDAI dealer.
- Do not operate the power tailgate under the following conditions. The power tailgate may not operate properly.
 - One side of the vehicle is lifted to inspect the vehicle or change a tire
 - Parking on an uneven road such as a slope, etc.
- Close the tailgate completely and lock all doors and tailgate using the central door lock button before using an automatic car wash.
- Do not spray high pressure water directly on the power tailgate outside open/close button. The tailgate may open unintentionally.

i Information

- If the tailgate is not fully closed and vehicle speed is at or above 3 km/h (1.8 mph), a warning will sound 10 times. Immediately park the vehicle at a safe place, close the tailgate, and check that the tailgate open warning on the instrument cluster is turned off.
- In cold and wet climates, the outside power tailgate open/close button may not work properly due to freezing conditions. If this occurs, remove the ice before using the outside power tailgate open/close button or use the power tailgate open/close button on the smart key or the instrument panel.
- Operating the power tailgate more than 5 times continuously could cause damage to the operating motor. If this occurs, the power tailgate will not operate to prevent the motor from overheating. If any of the power tailgate buttons are pressed to try to open the tailgate, the chime will sound 3 times, but the tailgate will remain closed. Allow the power tailgate system to cool for about 1 minute before operating the system again.

Power tailgate open/close button (Smart key, Instrument panel)(



When the tailgate is closed, press the power tailgate open/close button for 1 second. The power tailgate opens with a warning sound.

While the tailgate is opening, press the button to stop tailgate operation.

When the power tailgate is opened, press and hold the power tailgate open/close button to close the tailgate. If you release the button while the tailgate is closing, power tailgate operation will stop with a warning sound for 5 seconds.

Also, if the smart key is not within operation range (approximately 10 m) from the vehicle, power tailgate operation will stop with a warning sound for 5 seconds.

Power tailgate open/close button (Outside the power tailgate)



©NX41052010

When the tailgate is closed, press the power tailgate open/close button to open the tailgate.

If the vehicle is locked, press the power tailgate open/close button with the smart key in your possession.

If the tailgate is unlocked, the tailgate will open or close with a warning sound when the power tailgate open/close button is pressed without carrying the smart key.

Power tailgate open/close button (Inside the power tailgate)



©NX41052011

Press the power tailgate open/close button. The tailgate opens or closes with a warning sound.

Automatic reverse

During power tailgate operation if the power tailgate senses any obstacle, the tailgate will stop or will fully open. The automatic reverse feature may not operate properly, or it may operate unexpectedly under the following circumstances:

- The automatic reverse feature may not detect the resistance if the detected resistance is below a certain level, or if the tailgate is almost fully closed near the latched position.
- The automatic reverse feature may operate if a strong impact is applied with no obstructions placed.



WARNING

Never intentionally place any object or part of your body in the path of the power tailgate to make sure the automatic reverse feature operates. Serious injury, or damage to the vehicle or object may occur.



Information

The power tailgate may stop operating if the automatic reverse feature operates more than two times while attempting to open or close the tailgate. If this occurs, carefully open or close the tailgate manually, and then after 30 seconds try to operate the power tailgate automatically again.

Setting the power tailgate

To use each feature, you must select the opening speed or opening height from the settings menu. Deselect the settings when you do not want to use the feature.

Power tailgate opening speed

To adjust the power tailgate speed, select 'User Settings → Door → Power Tailgate Opening Speed → Fast/Normal' in the instrument cluster or 'Setup → Vehicle Settings → Door/Tailgate → Power Tailgate Opening Speed → Fast/Slow' in the infotainment system. (Default setting is 'Fast')

Power tailgate opening height

To adjust the power tailgate opening height, select 'User Settings → Door → Power Tailgate Opening Height → Full Open/Level 3/Level 2/Level 1/User Height Setting' in the instrument cluster or 'Setup → Vehicle Settings → Door/Tailgate → Power Tailgate Opening Height → Full Open/Level 3/Level 2/Level 1/User Height Setting' in the infotainment system.

The infotainment system may change after updates. For detailed information on system settings, see the infotainment system web manual.

User height setting

1. Position the tailgate manually to the height you prefer.
2. Press the power tailgate open/close button located inside the tailgate for more than 3 seconds.

If 'User Height Setting' is selected for the power tailgate opening height, the power tailgate will automatically open to the height manually set by you.

Information

- **If the power tailgate opening height has not been manually set, the power tailgate will fully open when 'User Height Setting' from the infotainment system is selected.**
- **If one of the height setting (Full Open/Level 3/Level 2/Level 1) is selected from the settings menu in the infotainment system, and then 'User Height Setting' is selected, the tailgate will open to the height manually set by you.**
- **The power tailgate opening speed and opening height settings change according to the linked User Profile. If the User Profile is changed, power tailgate opening speed and opening height settings will change accordingly.**

Resetting the power tailgate

In some circumstances resetting the power tailgate operation may need to be performed. Some instances where resetting the power tailgate may be required include:

- When the 12-volt battery is recharged
- When the 12-volt battery is reinstalled after removal or replacement
- When the related fuse is reinstalled after removal or replacement



1. With the engine off or running, put the gear in P (Park).
2. Press the power tailgate open/close inner button (A) and outer button (B) simultaneously until a chime sounds.

3. Slowly close the tailgate manually.
4. Press the power tailgate open/close outer button. The power tailgate will open with a chime sound.

Wait until the tailgate fully opens to complete resetting. If the tailgate stops before it is fully open, resetting cannot be completed.

***i* Information**

If the power tailgate does not operate properly after the above procedure, have the system inspected by an authorized HYUNDAI dealer.

Emergency tailgate safety release



To unlock and open the tailgate manually from inside the luggage compartment, perform the following procedure:

1. Insert a long, flat object, such as a key into the opening at the bottom of the tailgate.
2. Slide the latch in the direction of the arrow to unlock the tailgate.
3. Push the tailgate to open.



WARNING

- For emergencies, be fully aware of the location of the emergency tailgate safety release latch in the vehicle and how to open the tailgate if you are accidentally locked in the luggage compartment.
- No one, including animals, should be allowed to occupy the luggage compartment of the vehicle at any time. The luggage compartment is a very dangerous location in the event of an accident.
- Use the release latch for emergencies only. Use extreme caution, especially while the vehicle is in motion.

Smart tailgate (if equipped)



On a vehicle equipped with a smart key, the tailgate can be opened with hands-free activation using the smart tailgate system.

Using smart tailgate

The hands-free smart tailgate system can be opened automatically when the following conditions are met:

- The smart tailgate option is enabled in the Settings menu in the infotainment system screen.
- The smart tailgate is activated and ready 15 seconds after all the doors are closed and locked.
- The smart tailgate will open when the smart key is detected in the area behind the vehicle for 3 seconds.

i Information

The smart tailgate will NOT operate when:

- A door is not locked or closed.
- The smart key is detected within 15 seconds from when the doors were closed and locked.
- The smart key is detected within 15 seconds after the doors are closed and locked, and within 1.5 m (60 in.) from the front door handles. (for vehicles equipped with Welcome Light).
- The smart key is in the vehicle.

1. Settings

To activate the Smart Tailgate, go to User Settings Mode and select Smart Tailgate on the LCD display.

2. Detect and Alert

The smart tailgate detecting area extends approximately 50-100 cm (20-40 in.) behind the vehicle. If you are positioned in the detecting area and are carrying the smart key, the hazard warning lights will blink and the chime will sound to alert you that the smart tailgate will open.

i Information

Do not approach the detecting area if you do not want the tailgate to open. If you have unintentionally entered the detecting area and the hazard warning lights and chime starts to operate, move away from the area behind the vehicle with the smart key. The tailgate will remain closed.

3. Automatic opening

After the hazard warning lights blink and the chime sounds 6 times, the smart tailgate will open.

Deactivating smart tailgate



OTM050057L

1. Door lock
2. Door unlock
3. Tailgate lock / unlock (Tailgate)
Tailgate open / close (Power tailgate)

If you press any button on the smart key during the Detect and Alert stage, the smart tailgate will be deactivated.

Make sure to be aware of how to deactivate the smart tailgate for emergency situations.

- If you press the door unlock button (2), the smart tailgate will be deactivated temporarily. But, if you do not open any door for 30 seconds, the smart tailgate will be activated again.
- If you press the tailgate open button (3) for more than 1 second, the tailgate opens.
- The smart tailgate will still be activated if you press the door lock button (1) or tailgate open/close button (3) on the smart key as long as the smart tailgate is not already in the Detect and Alert stage.
- In case you have deactivated the smart tailgate by pressing the smart key button and opened a door, the smart tailgate can be activated again by closing and locking all doors.

Detecting area



- The smart tailgate detecting area extends approximately 50-100 cm (20-40 in.) behind the vehicle. If you are positioned in the detecting area and are carrying the smart key, the hazard warning lights will blink and the chime will sound for about 3 seconds to alert you that the tailgate will open.
- The alert stops once the smart key is moved outside of the detecting area within the 3 second period.

i Information

- **Smart tailgate may not operate properly if any of the following occur:**
 - The smart key is close to a radio transmitter such as a radio station or an airport which can interfere with normal operation of the transmitter.
 - The smart key is near a mobile two way radio system or a mobile phone.
 - Another vehicle's smart key is being operated close to your vehicle.
- **Smart tailgate detecting area may change when:**
 - The vehicle is parked on an incline or slope.
 - One side of the vehicle is raised or lowered relative to the opposite side.

Fuel filler door

Opening the fuel filler door



1. Turn the engine off.
2. Ensure the all doors are unlocked.
3. Press the rear center edge of the fuel filler door.



4. Pull the fuel filler door (1) outward to access the fuel tank cap.
5. To remove the fuel tank cap (2), turn it counterclockwise. You may hear a hissing noise as the pressure inside the tank equalizes.
6. Place the cap on the fuel filler door.

i Information

The fuel filler door will unlock when all doors are unlocked.

To unlock fuel filler door:

- Press the unlock button on your remote key or smart key
- Press the Central Door unlock button on the armrest of driver's door

The fuel filler door will lock when all doors are locked.

To lock fuel filler door:

- Press the lock button on your remote key or smart key
- Press the Central Door lock button on the armrest of driver's door
- * All doors will automatically lock after the vehicle speed exceeds 15km/h
Fuel filler door is also locked when vehicle speed exceeds 15km/h

i Information

Refer to Chapter 9, "Selective Catalytic Reduction (SCR)" section for information on urea solution for diesel engine vehicles.

i Information

If the fuel filler door does not open because ice has formed around it, tap lightly or push on the door to break the ice and release the door. Do not pry on the door. If necessary, spray around the door with an approved deicer fluid (do not use radiator antifreeze) or move the vehicle to a warm place and allow the ice to melt.

Closing the fuel filler door

1. To install the fuel tank cap, turn it clockwise until it “clicks” one time.
2. Close the fuel filler door until it is latched securely.

Information

Make the vehicle door to LOCK position and the fuel filler door completely closed in order to lock the fuel filler door.

If the fuel filler door is not completely closed, the fuel filler door will not be locked.

CAUTION

Keep the door into LOCK position when the vehicle is being washed (for example, high pressure washer, automatic car washer, etc.)

WARNING

Automotive fuel is highly flammable and explosive. Failure to follow these guidelines may result in SERIOUS INJURY or DEATH:

- **Read and follow all warnings posted at the gas station.**
- **Before refueling, note the location of the Emergency Fuel Shut-Off, if available, at the gas station.**
- **Before touching the fuel nozzle, you should eliminate the potential build-up of static electricity by touching a metal part of the vehicle, a safe distance away from the fuel filler neck, nozzle, or other gas source, with your bare hand.**
- **Do not use mobile phones while refueling. Electric current and/or electronic interference from cellular phones can potentially ignite fuel vapors and cause a fire.**
- **Do not get back into a vehicle once you have begun refueling. You can generate a buildup of static electricity by touching, rubbing or sliding against any item or fabric capable of producing static electricity. Static electricity discharge can ignite fuel vapors causing a fire. If you must re-enter the vehicle, you should once again eliminate potentially dangerous static electricity discharge by touching a metal part of the vehicle, away from the fuel filler neck, nozzle or other fuel source, with your bare hand.**

- When using an approved portable fuel container, be sure to place the container on the ground prior to refueling. Static electricity discharge from the container can ignite fuel vapors causing a fire.
Once refueling has begun, contact between your bare hand and the vehicle should be maintained until the filling is complete.
- Use only approved portable plastic fuel containers designed to carry and store fuel.
- When refueling, always shift the gear to the P (Park) position (for automatic transmission) or R (Reverse), set the parking brake, and place the ignition switch or Engine Start/Stop button to the LOCK/OFF position. Sparks produced by electrical components related to the engine can ignite fuel vapors causing a fire.
- Do not use matches or a lighter and do not smoke or leave a lit cigarette in your vehicle while at a gas station, especially during refueling.
- Do not over-fill or top-off your vehicle tank, which can cause fuel spillage.
- If a fire breaks out during refueling, leave the vicinity of the vehicle, and immediately contact the manager of the gas station and then contact the local fire department. Follow any safety instructions they provide.
- If pressurized fuel sprays out, it can cover your clothes or skin and thus subject you to the risk of fire and burns. Always remove the fuel cap carefully and slowly. If the cap is venting fuel or if you hear a hissing sound, wait until the condition stops before completely removing the cap.
- Always check that the fuel cap is installed securely to prevent fuel spillage in the event of an accident.

Information

Make sure to refuel your vehicle according to the “Fuel Requirements” section as recommended in chapter 1.

NOTICE

- Do not spill fuel on the exterior surfaces of the vehicle. Any type of fuel spilled on painted surfaces may damage the paint.
- If the fuel filler cap requires replacement, we recommend that you use only a genuine HYUNDAI cap or the equivalent specified for your vehicle. An incorrect fuel filler cap can result in a serious malfunction of the fuel system or emission control system.

LIGHTING

Exterior lights

Lighting control

To operate the lights, turn the knob at the end of the control lever to one of the following positions:



1. OFF (O)
2. AUTO light (if equipped)
3. Position lamp
4. Headlamp

Daytime Running Light (DRL)

The Daytime Running Lights (DRL) can make it easier for others to see the front of your vehicle during the day, especially after dawn and before sunset.

The DRL system will turn the dedicated lamp OFF when :

- The headlamps are ON.
- The parking brake is applied.
- The vehicle is turned off.



AUTO headlamp

The position lamp and headlamp will be turned ON or OFF automatically depending on the amount of daylight as measured by the ambient light sensor (1) at the upper end of the windshield glass.

Even with the AUTO headlamp feature in operation, it is recommended to manually turn ON the headlamps when driving at night or in a fog, driving in the rain, or when you enter dark areas, such as tunnels and parking facilities.

NOTICE

- **Do not cover or spill anything on the sensor (1) located at the upper end of the windshield glass.**
- **Do not clean the sensor using a window cleaner, the cleanser may leave a light film which could interfere with sensor operation.**
- **If your vehicle has window tint or other types of metallic coating on the front windshield, the AUTO headlamp system may not work properly.**



ONX4E050065

Position lamp (☞☜)

The position lamp, license plate lamp and instrument panel lamp are turned ON.



ONX4E050066

Headlamp (☞☜)

The headlamp, position lamp, license plate lamp and instrument panel lamp are turned ON.

i Information

The ignition switch or Engine Start/Stop button must be in the ON position to turn on the headlamp.

High beam operation



ONX4E050067

To turn on the high beam headlamp, push the lever away from you. The lever will return to its original position.

The high beam indicator will light when the headlamp high beams are switched on.

To turn off the high beam headlamp, pull the lever towards you. The low beams will turn on.



WARNING

Do not use high beam when there are other vehicles approaching you. Using high beam could obstruct the other driver's vision.



ONX4E050068

To flash the high beam headlamp, pull the lever towards you, then release the lever. The high beams will remain ON as long as you hold the lever towards you.

Turn signals and lane change signals



To signal a turn, push down on the lever for a left turn or up for a right turn in position (A). To signal a lane change, move the turn signal lever slightly and hold it in position (B).

The lever will return to the OFF position when released or when the turn is completed.

If an indicator stays on and does not flash or if it flashes abnormally, one of the turn signal bulbs may be burned out and will require replacement.

One touch turn signal

To use One Touch Turn Signal push the turn signal lever up or down to position (B) and then release it.

The lane change signals will blink 3, 5 or 7 times.

You can enable the One Touch Turn Signal function or choose the number of blinking by selecting 'Setup → User Settings → Lights → One Touch Turn Signal → Off/3 flashes/5 flashes/7 flashes' in the instrument panel LCD cluster.

Rear fog lamp (if equipped)



To turn on the rear fog lamp:

Position the headlamp switch in the headlamp position, and then turn the headlamp switch (1) to the rear fog lamp position.

To turn the rear fog lamps off, do one of the following:

- Turn off the headlamp switch.
- Turn the headlamp switch (1) to the rear fog lamp position again.

Battery saver function

The purpose of this feature is to prevent the battery from being discharged.

The system automatically turns off the position lamp when the driver turns the vehicle off and opens the driver-side door.

With this feature, the position lamps will turn off automatically if the driver parks on the side of road at night.

However, the position lamps stay ON even when the driver-side door is opened if the headlamp switch is turned to the position lamp or AUTO (if equipped) position after the engine is turned off.

If necessary, to keep the lamps on turn the position lamps OFF and ON again using the headlamp switch on the steering column after the engine is turned off.

Headlamp delay function (if equipped)

If you place the ignition switch or Engine Start/Stop button to the ACC position or the OFF position with the headlamps ON, the headlamps (and/or position lamps) remain on for about 5 minutes. However, if the driver's door is opened and closed, the headlamps are turned off after 15 seconds. Also, with the vehicle off if the driver's door is opened and closed, the headlamps (and/or position lamps) are turned off after 15 seconds.

The headlamps (and/or position lamps) can be turned off by pressing the lock button on the remote key or smart key twice or turning the headlamp switch to the OFF or AUTO position.

You can enable the headlamp delay function by selecting 'Setup → User Settings → Lights → Headlight Delay.

NOTICE

If the driver exits the vehicle through another door besides the driver door, the battery saver function does not operate and the headlamp delay function does not turn OFF automatically.

This may cause the battery to discharge. To avoid battery discharge, turn OFF the headlamps manually from the headlamp switch before exiting the vehicle.

Headlamp leveling device



Manual type (if equipped)

To adjust the headlamp beam level according to the number of the passengers and loading weight in the luggage area, turn the beam leveling switch.

The higher the number on the switch position, the lower the headlamp beam level. Always keep the headlamp beam at the proper leveling position, otherwise headlamps may dazzle other road users.

Listed below are examples of appropriate switch settings for varying loads. For loading conditions other than those listed, adjust the switch position to the most similar situation.

Loading condition	Switch position
Driver only	0
Driver + Front passenger	0
Full passengers (including driver)	1
Full passengers (including driver) + Maximum permissible loading	2
Driver + Maximum permissible loading	3

WARNING

If the function does not work properly, we recommend that the system be inspected by an authorized HYUNDAI dealer. Do not attempt to inspect or replace the wiring yourself.

Low Beam Assist-Static light (if equipped)

While driving a corner, for greater visibility and safety, either the left or right side Low Beam Assist-Static light will turn on automatically. The Low Beam Assist-Static light will turn on when one of the following conditions occur.

Vehicle speed is less than 10 km/h (6 mph) and steering wheel angle is turned approximately 80 degrees with the low beam on.

Vehicle speed is between 10 km/h (6 mph) to 90 km/h (56 mph) and steering wheel angle is turned approximately 35 degrees with the low beam on.

When the vehicle is in reverse with one of the conditions above satisfied, the light opposite to the direction the steering wheel is turned will turn on.

HIGH BEAM ASSIST (HBA) (IF EQUIPPED)



ODN8059206

High Beam Assist will automatically adjust the headlamp range (switches between high beam and low beam) depending on the brightness of detected vehicles and certain road conditions.

Detecting sensor



©NX4N071005L

[1] : Front view camera

The front view camera is used as a detecting sensor to detect ambient light and brightness while driving.

Refer to the picture above for the detailed location of the detecting sensor.

NOTICE

- Always keep the front view camera in good condition to maintain optimal performance of High Beam Assist.
- For more details on the precautions of the front view camera, refer to “Forward Collision-Avoidance Assist (FCA)” section in chapter 7.

High Beam Assist settings

With the engine on, select ‘Lights → High Beam Assist (or HBA (High Beam Assist))’ from the Settings menu to turn on High Beam Assist and deselect to turn off the function.



WARNING

For your safety, change the Settings after parking the vehicle at a safe location.

High Beam Assist operation

Display and control

- After selecting 'High Beam Assist' in the Settings menu, High Beam Assist will operate by following the procedure below.
 - Place the headlamp switch in the AUTO position and push the headlamp lever towards the instrument cluster. The High Beam Assist (AUTO) indicator light will illuminate on the cluster and High Beam Assist will be enabled.
 - When High Beam Assist is enabled, high beam will turn on when vehicle speed is above 40 km/h (25 mph). When vehicle speed is below 25 km/h (15 mph), high beam will turn off.
 - The High Beam (HBA) indicator light will illuminate on the cluster when high beam is on.
- When High Beam Assist is operating, if the headlamp lever or switch is used, High Beam Assist operates as follow:
 - If the headlamp lever is pulled towards you when the high beam is off, the high beam will turn on without High Beam Assist cancelled. When you let go of the headlamp lever, the switch will move to the middle and the high beam will turn off.
 - If the headlamp switch is pulled towards you when the high beam is on by High Beam Assist, low beam will turn on and High Beam Assist will turn off.
 - If the headlamp switch is placed from AUTO to another position (headlamp/position/off), High Beam Assist will turn off and the corresponding lamp will turn on.

- When High Beam Assist is operating, high beam switches to low beam if any of the following conditions occur:
 - When the headlamp of an oncoming vehicle is detected.
 - When the tail lamp of a vehicle in front is detected.
 - When the headlamp or tail lamp of a motorcycle or a bicycle is detected.
 - When the surrounding ambient light is bright enough that high beams are not required.
 - When streetlights or other lights are detected.

High Beam Assist malfunction and limitations

High Beam Assist malfunction

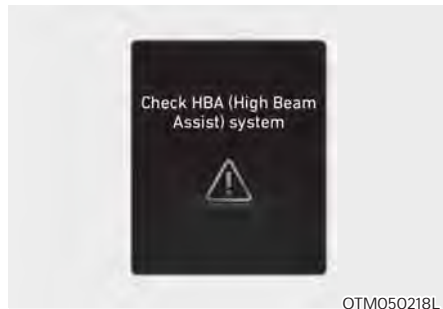

When High Beam Assist is not working properly, the 'Check High Beam Assist (HBA) system' or 'Check HBA (High Beam Assist) system' warning message will appear and  warning light will illuminate on the cluster. We recommend that the vehicle be inspected by an authorized HYUNDAI dealer.

Limitations of High Beam Assist

High Beam Assist may not work properly in the following situations:

- Light from an oncoming or front vehicle is not detected because of lamp damage, or because it is hidden from sight, etc.
- Headlamp of an oncoming or front vehicle is covered with dust, snow or water.
- A front vehicle's headlamps are off but the fog lamps are on and etc.
- There is a lamp that has a similar shape as a vehicle's lamp.
- Headlamps have been damaged or not repaired properly.
- Headlamps are not aimed properly.
- Driving on a narrow-curved road, rough road, uphill or downhill.
- Vehicle in front is partially visible on a crossroad or curved road.
- There is a traffic light, reflecting sign, flashing sign or mirror ahead.
- There is a temporary reflector or flash ahead (construction area).
- The road conditions are bad such as being wet, iced or covered with snow.
- A vehicle suddenly appears from a curve.
- The vehicle is tilted from a flat tire or is being towed.
- Light from an oncoming or front vehicle is not detected due to obstacles in the air such as exhaust fume, smoke, fog, snow, or water spray or blizzard on the road, or fogging in the lamp, etc.



WARNING

- **At times, High Beam Assist may not work properly. The function is for your convenience only. It is the responsibility of the driver for safe driving practices and always check the road conditions for your safety.**
- **When High Beam Assist does not operate normally, change the headlamp position manually between high beam and low beam.**



Information

For more details on the limitations of the front view camera, refer to “Forward Collision-Avoidance Assist (FCA)” section in chapter 7.

INTERIOR LIGHTS

WARNING

Do not use the interior lights when driving in the dark. The interior lights may obscure your view and cause an accident.

NOTICE

Do not use the interior lights for extended periods when the vehicle is turned off or the battery will discharge.

Interior lamp AUTO cut

The interior lamps will automatically go off approximately 10 minutes after the vehicle is turned off and the doors are closed. If a door is opened, the lamp will go off 40 minutes after the vehicle is turned off. If the doors are locked by the remote key or smart key and the vehicle enters the armed stage of the theft alarm system, the lamps will go off five seconds later.

Front lamps



- (1) Front Map Lamp
- (2) Front Door Lamp
- (3) Front Room Lamp ON/OFF

Front map lamp :

Touch either icons to turn the map lamp on or off. This light produces a spot beam for convenient use as a map lamp at night or as a personal lamp for the driver and the front passenger.

Door lamp :

The front or rear room lamps come on when the front or rear doors are opened. When doors are unlocked by the remote key or smart key, the front and rear lamps come on for approximately 30 seconds as long as any door is not opened. The front and rear room lamps go out gradually after approximately 30 seconds when the door is closed. However, if the ignition switch or Engine Start/Stop button is in the ON position or all doors are locked, the front and rear lamps will turn off. If a door is opened with the ignition switch or Engine Start/Stop button in the ACC position or the LOCK/OFF position, the front and rear lamps will stay on for about 20 minutes.

Room lamp :

Press the button to turn ON the room lamp for the front/rear seats.

Rear lamps (if equipped)

■ Type A



■ Type B





Rear room lamp switch :

Press this button to turn the room lamp on and off.

Vanity mirror lamp (if equipped)



Push the switch to turn the light on or off.

-  : The lamp will turn on if this button is pressed.
-  : The lamp will turn off if this button is pressed.

Glove box lamp



The glove box lamp turns on when the glove box is opened.

Luggage compartment lamp



The luggage compartment lamp is on when the tailgate is opened.

The luggage compartment lamp is off when the tailgate is closed.

Welcome system



Welcome system helps keep the driver visible by turning on vehicle lights when the driver approaches the vehicle.

Door handle lamp

When all the doors (and tailgate) are closed and locked, the door handle lamp will turn on for approximately 15 seconds if any of the below is performed.

1. If 'Convenience → Welcome mirror/light → On door unlock' is selected in the User Settings mode on the LCD display,
 - the lamps will turn on when the door lock button is pressed on the remote key or smart key.
 - the lamps will turn on when the button of the outside door handle is pressed with the remote key or smart key in possession.
2. If both 'Convenience → Welcome mirror/light → On door unlock' and 'Convenience → Welcome mirror/light → On driver approach' is selected in the User Settings mode on the LCD display, the lamps will turn on when the vehicle is approached with the remote key or smart key in possession.

You can activate or deactivate Welcome Light function from the User Settings mode on the LCD display.

Headlamp and position lamp

When the headlamp (lamp switch in the headlamp or AUTO position) is on and all doors (and tailgate) are locked and closed, the position lamp and headlamp will come on for 15 seconds when the door unlock button is pressed on the remote key or smart key.

At this time, if you press the door lock or unlock button, the position lamp and headlamp will turn off immediately.

Interior lamp

When the interior lamp switch is in the  position and all doors (and tailgate) are closed and locked, the room lamp will come on for 30 seconds if any of the below is performed.

- When the door unlock button is pressed on the remote key or smart key.
- When you put your hand in the outside door handle while carrying the remote key or smart key.

At this time, if you press the door lock or unlock button on the remote key or smart key the lamps will turn off immediately.

WIPERS AND WASHERS



- A. Wiper speed control (front)
- V / MIST – Single wipe
 - O / OFF – Off
 - --- / INT – Intermittent wipe
 - AUTO* – Auto control wipe
 - 1 / LO– Low wiper speed
 - 2 / HI – High wiper speed
- B. Intermittent control wipe time adjustment
- C. Wash with brief wipes (front)



- D. Rear wiper control*
- 2 / HI – High wiper speed
 - 1 / LO– Low wiper speed
 - O / OFF – Off
- E. Wash with brief wipes (rear)
- * : if equipped

Windshield wipers

Operates as follows when the ignition switch or Engine Start/Stop button is turned ON.

V (MIST) : For a single wiping cycle, move the lever down (V) or up (MIST) and release it. The wipers will operate continuously if the lever is held in this position.

O (OFF) : Wipers are not in operation.

--- (INT) : Wipers operate intermittently at the same wiping intervals. Use this mode in light rain or mist. To vary the speed setting, turn the speed control knob.

1 (LO) : The wiper runs at a lower speed.

2 (HI) : The wiper runs at a higher speed.

Information

If there is heavy accumulation of snow or ice on the windshield, defrost the windshield for about 10 minutes, or until the snow and/or ice is removed before using the windshield wipers to ensure proper operation.

If you do not remove the snow and/or ice before using the wiper and washer, it may damage the wiper and washer system.

AUTO (Automatic) control (if equipped)



The rain sensor located on the upper end of the windshield glass senses the amount of rainfall and controls the wiping cycle for the proper interval.

The wiper operation time will be automatically controlled depends on rainfall.

When the rain stops, the wiper stops.

To vary the sensitivity setting, turn the sensitivity control knob.

If the wiper switch is set in AUTO mode when the ignition switch or Engine Start/Stop button is in the ON position, the wiper will operate once to perform a self-check of the system. Set the wiper to the OFF (O) position when the wiper is not in use.

WARNING

To avoid personal injury from the windshield wipers, when the engine is running and the windshield wiper switch is placed in the AUTO mode:

- Do not touch the upper end of the windshield glass facing the rain sensor.
- Do not wipe the upper end of the windshield glass with a damp or wet cloth.
- Do not put pressure on the windshield glass.

NOTICE

- When washing the vehicle, set the wiper switch in the OFF (O) position to stop the auto wiper operation. The wiper may operate and be damaged if the switch is set in the AUTO mode while washing the vehicle.
- Do not remove the sensor cover located on the upper end of the passenger side windshield glass. Damage to system components could occur and may not be covered by your vehicle warranty.
- Because of using a photo sensor, temporary malfunction could occur according to sudden ambient light change made by stone and dust while driving.

Front windshield washers



In the OFF (O) position, pull the lever gently toward you to spray washer fluid on the windshield and to run the wipers 1-3 cycles. The spray and wiper operation will continue until you release the lever. If the washer does not work, you may need to add washer fluid to the washer fluid reservoir.

Recirculating air when washer fluid is used

When washer fluid is used, in order to reduce any objectionable scent of the washer fluid from entering the cabin, recirculation mode and air conditioning are automatically activated depending on the outside temperature. If you select fresh mode while the function is operating, the function will resume after a certain amount of time. It may not work in some conditions such as cold weather or engine OFF.

For more details, refer to “Climate Control Additional Features” section in this chapter.



WARNING

When the outside temperature is below freezing, **ALWAYS** warm the windshield using the defroster to help prevent the washer fluid from freezing on the windshield and obscuring your vision which could result in an accident and serious injury or death.

NOTICE

- To prevent possible damage to the washer pump, do not operate the washer when the fluid reservoir is empty.
- To prevent possible damage to the wipers or windshield, do not operate the wipers when the windshield is dry.
- To prevent damage to the wiper arms and other components, do not attempt to move the wipers manually.
- To prevent possible damage to the wipers and washer system, use anti-freezing washer fluids in the winter season or cold weather.

Rear window wiper and washer

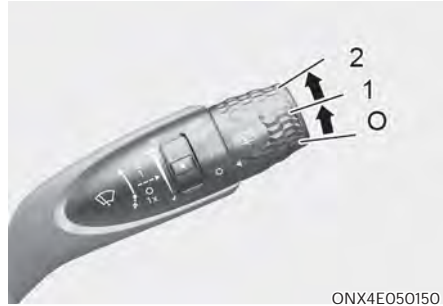

The rear window wiper and washer switch is located at the end of the wiper and washer switch lever. Turn the switch to the desired position to operate the rear wiper and washer.

- HI (2) – High wiper speed
- LO (1) – Low wiper speed
- OFF (O) – Off



Push the lever away from you to spray rear washer fluid and to run the rear wipers 1~3 cycles. The spray and wiper operation will continue until you release the lever.

Auto rear wiper (if equipped)

The rear wiper will operate while the vehicle is in reverse with the front wiper ON by selecting the function from the Settings menu on the LCD display. Select:

- Setup → User Settings → Convenience → Auto Rear Wiper (in R)

MANUAL CLIMATE CONTROL SYSTEM (IF EQUIPPED)

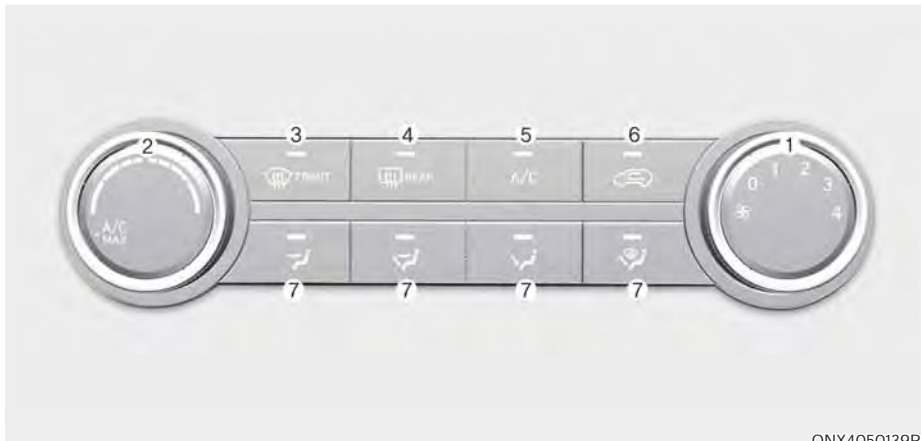



ONX4050139R

1. Fan speed control knob
2. Temperature control knob
3. Front windshield defroster button
4. Rear window defroster button
5. A/C (air conditioning) button
6. Air intake control button
7. Mode selection button

Heating and air conditioning

1. Start the engine.
2. Set the mode to the desired position.

To improve the effectiveness of heating and cooling, select:

- Heating: 
- Cooling: 

3. Set the temperature control to the desired position.
4. Set the air intake control to Fresh mode.
5. Set the fan speed control to the desired speed.
6. If air conditioning is desired, turn the air conditioning system on.

Mode selection





The mode selection button controls the direction of the air flow through the ventilation system.

 **Face-Level (B, C, E)**

Air flow is directed toward the upper body and face. Additionally, each outlet can be controlled to direct the air discharged from the outlet.

 **Bi-Level (B, C, D, E, F)**

Air flow is directed towards the face and the floor.

 **Floor-Level (A, B, D, E, F)**

Most of the air flow is directed to the floor, with a small amount of the air being directed to the windshield and side window defrosters.

 **Floor/Defrost-Level (A, B, D, E, F)**

Most of the air flow is directed to the floor and the windshield with a small amount directed to the side window defrosters.

 **FRONT Front defroster (A, B)**

Most of the air flow is directed to the windshield with a small amount of air directed to the side window defrosters.



MAX A/C-Level (B,C,E) (if equipped)

The MAX A/C mode is used to cool the inside of the vehicle faster. Air flow is directed toward the upper body and face.

In this mode, the air conditioning and the recirculated air position is selected. Turn the fan speed mode to adjust.

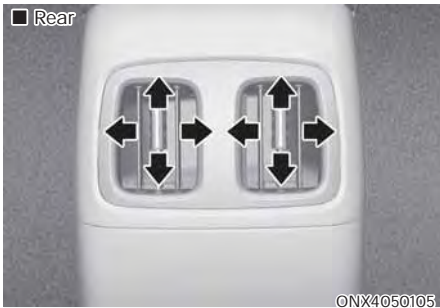
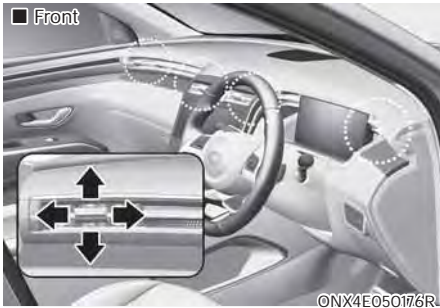

Instrument panel vents

The instrument panel vent air flow can be directed up/down or left/right using the vent adjustment lever.

The air flow can also be CLOSED using the vent adjustment lever.

Move the lever to ⊗ position to close, and to ☰ position to open.

Temperature control



The temperature will increase by turning the knob to the right. The temperature will decrease by turning the knob to the left.

Recirculation mode



When Recirculation mode is selected, air from the passenger compartment will be recirculated through the system and heated or cooled according to the function selected.

Outside (fresh) air position

■ Type A



With the outside (fresh) air position selected, air enters the vehicle from outside and is heated or cooled according to the function selected.

■ Type B



i Information

Operating the system primarily in Fresh mode is recommended. Use Recirculation mode temporarily only when needed.

Prolonged operation of the heater in Recirculation mode and without the A/C ON can cause fogging of the windshield.

In addition, prolonged use of the A/C ON in Recirculation mode may result in excessively dry, dehumidified air in the cabin and may promote formation of musty vent odor due to stagnant air.

⚠ WARNING

- Continued use of the climate control system operation in Recirculation mode for a prolonged period of time may cause drowsiness to the occupants in the cabin. This may lead to loss of vehicle control which may lead to an accident.
- Continued use of the climate control system operation in Recirculation mode with the A/C OFF may allow humidity to increase inside the cabin.
- This may cause condensation to accumulate on the windshield and obscure visibility.
- Do not sleep in your vehicle or remain parked in your vehicle with the windows up and either the heater or the air conditioning ON for prolonged periods of time. Doing so may increase the levels of carbon dioxide in the cabin which may lead to serious injury or death.

Fan speed control



ONX4E050107

Turn the knob to the right to increase the fan speed and airflow. Turn the knob to the left to decrease fan speed and airflow.

Setting the fan speed control knob to the "0" position turns off the fan.

NOTICE

Operating the fan speed when the ignition switch or Engine Start/Stop button is in the ON position could cause the battery to discharge. Operate the fan speed when the engine is running.

Air conditioning (A/C) (if equipped)



Press the A/C button to turn the air conditioning system on (indicator light will illuminate). Press the button again to turn the air conditioning system off.

System operation

Ventilation

1. Select the Face Level  mode.
2. Set the air intake control to fresh mode.
3. Set the temperature control to the desired position.
4. Set the fan speed control to the desired speed.

Heating

1. Select the Floor Level  mode.
2. Set the air intake control to fresh mode.
3. Set the temperature control to the desired position.
4. Set the fan speed control to the desired speed.
5. If desired, turn the air conditioning ON with the temperature control knob set to heat in order to dehumidify the air before it enters into the cabin.

If the windshield fog up, select the front windshield defroster button.

Operation Tips

- To keep dust or unpleasant fumes from entering the vehicle through the ventilation system, temporarily set the air intake control to the recirculation mode. Be sure to return the control to fresh mode position when the irritation has passed to keep fresh air in the vehicle. This will help keep the driver alert and comfortable.
- To prevent interior fog on the windshield, set the air intake control to fresh mode and fan speed to the desired position, turn on the air conditioning system, and adjust the temperature control to desired temperature.

Air conditioning

HYUNDAI Air Conditioning Systems are filled with R-134a or R-1234yf refrigerant.

1. Start the engine. Push the air conditioning button.
2. Select the Face Level  mode.
3. Set the air intake control to Recirculation mode temporarily to allow the cabin to cool quickly. When the desired temperature in the cabin is reached, change the air intake control back to Fresh mode.
4. Adjust the fan speed control and temperature control to maintain maximum comfort.

NOTICE

When using the air conditioning system, monitor the temperature gauge closely while driving up hills or in heavy traffic when outside temperatures are high. Air conditioning system operation may cause engine overheating. Continue to use the fan but turn the air conditioning system off if the temperature gauge indicates engine overheating.

Air conditioning system operation tips

- If the vehicle has been parked in direct sunlight during hot weather, open the windows for a short time to let the hot air inside the vehicle escape.
- After sufficient cooling has been achieved, switch back from recirculation mode to fresh mode.
- To help reduce moisture inside of the windows on rainy or humid days, decrease the humidity inside the vehicle by operating the air conditioning system with the windows and sunroof closed.
- During air conditioning system operation, you may occasionally notice a slight change in engine speed as the air conditioning compressor cycles. This is a normal system operation characteristic.
- Use the air conditioning system every month for a few minutes to ensure maximum system performance.
- When using the air conditioning system, you may notice clear water dripping (or even puddling) on the ground under the passenger side of the vehicle. This is a normal system operation characteristic.
- If you operate the air conditioner excessively, the difference between the temperature of the outside air and that of the windshield could cause the outer surface of the windshield to fog up, causing loss of visibility. In this case, set the mode selection knob to the  position and set the fan speed control knob to the lowest speed setting.

System maintenance

Cabin air filter

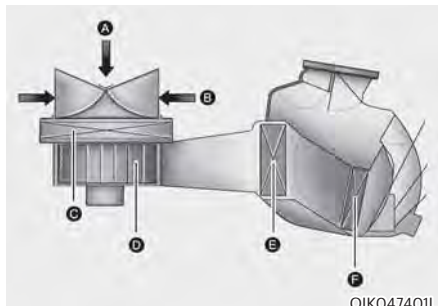

[A] : Outside air, [B] : Recirculated air

[C] : Cabin air filter, [D] : Blower

[E] : Evaporator core, [F] : Heater core

This filter is installed behind the glove box. It filters the dust or other pollutants that enter the vehicle through the heating and air conditioning system.

We recommend that the climate control air filter be replaced by an authorized HYUNDAI dealer according to the maintenance schedule. If the vehicle is being driven in severe conditions such as dusty or rough roads, more frequent climate control filter inspections and changes are required.

If the air flow rate suddenly decreases, we recommend the system be checked at an authorized HYUNDAI dealer.

i Information

Replace the filter according to the Maintenance Schedule.

If the car is being driven in severe conditions such as dusty, rough roads, more frequent climate control air filter inspections and changes are required.

When the air flow rate suddenly decreases, we recommend that the system be checked by an authorized HYUNDAI dealer.

Checking the amount of air conditioner refrigerant and compressor lubricant

When the amount of refrigerant is low, the performance of the air conditioning is reduced. Overfilling also reduces the performance of the air conditioning system.

Therefore, if abnormal operation is found, we recommend that the system be inspected by an authorized HYUNDAI dealer.

NOTICE

It is important that the correct type and amount of oil and refrigerant is used. Otherwise, damage to the compressor and abnormal system operation may occur. To prevent damage, the air conditioning system in your vehicle should only be serviced by trained and certified technicians.

 **WARNING**

Vehicles equipped with R-134a



Since the refrigerant is operated at very high pressure, the air conditioning system should only be serviced by trained and certified technicians.

All refrigerants should be reclaimed with proper equipment.

Venting refrigerants directly to the atmosphere is harmful to individuals and environment. Failure to heed these warnings can lead to serious injuries.

 **WARNING**

Vehicles equipped with R-1234yf



Since the refrigerant is mildly flammable and operated at high pressure, the air conditioning system should only be serviced by trained and certified technicians. It is important that the correct type and amount of oil and refrigerant are used.

All refrigerants should be reclaimed with proper equipment.

Venting refrigerants directly to the atmosphere is harmful to individuals and environment. Failure to heed these warnings can lead to serious injuries.

AUTOMATIC CLIMATE CONTROL SYSTEM (IF EQUIPPED)



1. Driver's temperature control button/ knob
2. Passenger's temperature control button/knob
3. AUTO (automatic control) button
4. Air intake control button
5. OFF button
6. Front windscreen defroster button
7. A/C (air conditioning) button
8. Blower speed control button
8. Mode selection button
9. Multi Air Mode button
10. Rear window defroster button
11. Rear window defroster button
12. SYNC button
13. Climate control information screen

Automatic heating and air conditioning

The Automatic Climate Control System is controlled by setting the desired temperature.

1. Press the AUTO button.

The modes, fan speeds, air intake and air-conditioning will be controlled automatically by the temperature setting you select.

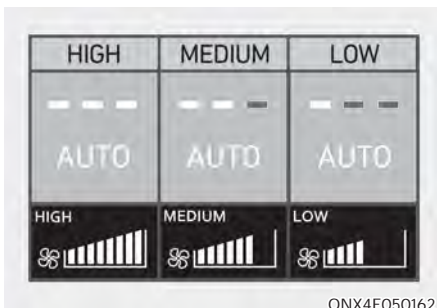

You can control the wind strength in three stages by pushing the AUTO button during automatic operation.

- HIGH : Provide rapid air conditioning and heating with strong wind
- MEDIUM : Provide air conditioning and heating with medium strength wind
- LOW : It is suitable for drivers who prefer to soft wind.

2. Turn the temperature control button/knob to set the desired temperature. If the temperature is set to the lowest setting (Lo), the air conditioning system will operate continuously.

After the interior has cooled sufficiently, adjust the button/knob to a higher temperature set point whenever possible.

To turn the automatic operation off, select any button of the following:

- Mode selection button
- Front windshield defroster button (Press the button one more time to deselect the front windshield defroster function. The 'AUTO' sign will illuminate on the information display once again.)
- Fan speed control button
The selected function will be controlled manually while other functions operate automatically.



For your convenience and to improve the effectiveness of the climate control, use the AUTO button and set the temperature to 22°C (72°F).



i Information

Never place anything near the sensor to ensure better control of the heating and cooling system.

Manual heating and air conditioning

1. Start the engine.
2. Set the mode to the desired position.
For improving the effectiveness of heating and cooling, select:
 - Heating: 
 - Cooling: 
3. Set the temperature control to the desired position.
4. Set the air intake control to fresh mode.
5. Set the fan speed control to the desired speed.
6. If air conditioning is desired, turn the air conditioning system on.
7. Press the AUTO button to convert to full automatic control of the system.

Mode selection

ONX4I052101



ONX4050117

The mode selection button controls the direction of the air flow through the ventilation system.

The air flow outlet direction is cycled as follows:

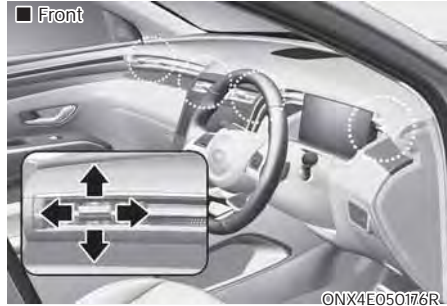

ONX4E05017/6R



ONX4050105

Instrument panel vents

The instrument panel vent air flow can be directed up/down or left/right using the vent adjustment lever.

The air flow can also be CLOSED using the vent adjustment lever.

Move the lever to ⊗ position to close, and to ☼ position to open. However, the third row air vent cannot be closed.

Type A, B



Air flow is directed toward the upper body and face. Additionally, each outlet can be controlled to direct the air discharged from the outlet.



Air flow is directed towards the face and the floor.



Most of the air flow is directed to the floor, with a small amount of the air being directed to the windshield and side window defrosters.



Most of the air flow is directed to the floor and the windshield with a small amount directed to the side window defrosters.



Most of the air flow is directed to the windshield with a small amount of air directed to the side window defrosters.



Gentle breezes come out the outlet vents.

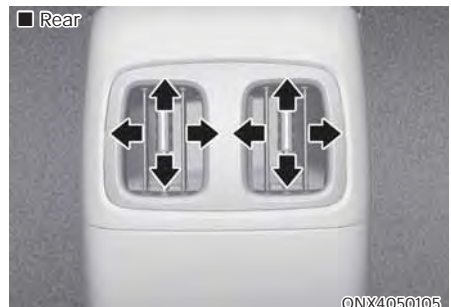
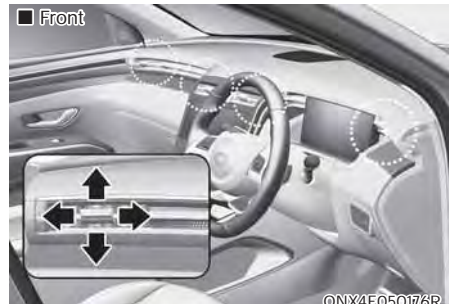

Instrument panel vents

The instrument panel vent air flow can be directed up/down or left/right using the vent adjustment lever.

The air flow can also be CLOSED using the vent adjustment lever.

Move the lever to ⊗ position to close, and to ☺ position to open.

Temperature control

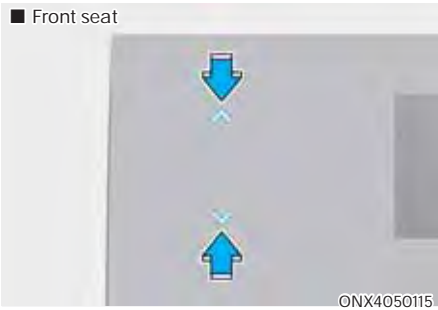

The temperature will increase by pushing the knob upward. The temperature will decrease by pushing the knob downward.



Adjusting the temperature equally

Press the SYNC button (indicator light ON) to adjust the driver and passenger side and the rear seat's temperature equally.

Adjusting the temperature and individually

Press the SYNC button (indicator light OFF) again to adjust the driver and passenger side and the rear seat's temperature individually.

Temperature conversion

If the battery has been discharged or disconnected, the temperature mode display will reset to Centigrade.

To change the temperature unit from °C to °F or °F to °C :

- Instrument cluster or infotainment system screen
Go to Setup → Unit → Temperature unit.

The temperature unit on both the cluster LCD display and the climate control screen will change.

Air intake control

The air intake control button is used to select either Fresh mode (outside air) or Recirculation mode (cabin air).

Recirculation mode



When Recirculation mode is selected, air from the passenger compartment will be recirculated through the system and heated or cooled according to the function selected.

Fresh mode



When Fresh mode is selected, air enters the vehicle from outside and is heated or cooled according to the function selected.

i Information

Operating the system primarily in Fresh mode is recommended. Use Recirculation mode temporarily only when needed. Prolonged operation of the heater in Recirculation mode and without the air conditioning ON can cause fogging of the windshield. In addition, prolonged use of the air conditioning ON in Recirculation mode may result in excessively dry, dehumidified air in the cabin and may promote formation of musty vent odor due to stagnant air.



WARNING

- Continued use of the climate control system operation in Recirculation mode for a prolonged period of time may cause drowsiness to the occupants in the cabin. This may lead to loss of vehicle control which may lead to an accident.
- Continued use of the climate control system operation in Recirculation mode with the air conditioning OFF may allow humidity to increase inside the cabin. This may cause condensation to accumulate on the windshield and obscure visibility.
- Do not sleep in your vehicle or remain parked in your vehicle with the windows up and either the heater or the air conditioning ON for prolonged periods of time. Doing so may increase the levels of carbon dioxide in the cabin which may lead to serious injury or death.

Fan speed control

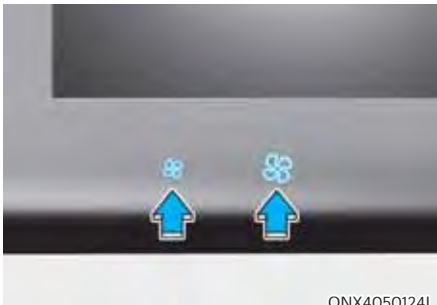

ONX4050124L

The fan speed can be set as desired by pushing the fan speed control button.

More air is delivered with higher fan speeds.

Pressing the OFF button turns off the fan.

NOTICE

Operating the fan when the ignition switch or Engine Start/Stop button is in the ON position could cause the battery to discharge. Operate the fan when the engine is running.

Air conditioning



Push the A/C button to turn the air conditioning system on (indicator light will illuminate).

Push the button again to turn the air conditioning system off.

OFF mode



Push the OFF button to turn the climate control system off. However, you can still operate the mode and air intake buttons as long as the ignition switch or Engine Start/Stop button is in the ON position.

Multi Air Mode (if equipped)





ONX4050128

If the multi air mode button is pressed, gentle breezes from the outlet vents will provide a pleasant condition.

If the multi air mode button is pressed when the air volume is beyond level 4, it decreases to Level 3.

OFF

If you press the button once more, it returns to the previous multi air mode. If you press the mode selection button, it operates according to the altered wind direction.



System operation

Ventilation

1. Select the Face Level  mode.
2. Set the air intake control to fresh mode.
3. Set the temperature control to the desired position.
4. Set the fan speed control to the desired speed.

Heating

1. Select the Floor Level  mode.
2. Set the air intake control to fresh mode.
3. Set the temperature control to the desired position.
4. Set the fan speed control to the desired speed.
5. If desired, turn the air conditioning ON with the temperature control knob set to heat in order to dehumidify the air before it enters into the cabin.

If the windshield fogs up, select the Floor & Defrost  mode or rotate the mode  selecting knob to the Defrost mode.

Operation Tips

- To keep dust or unpleasant fumes from entering the vehicle through the ventilation system, temporarily set the air intake control to the recirculation mode. Be sure to return the control to fresh mode position when the irritation has passed to keep fresh air in the vehicle. This will help keep the driver alert and comfortable.
- To prevent interior fog on the windshield, set the air intake control to fresh mode and fan speed to the desired position, turn on the air conditioning system, and adjust the temperature control to desired temperature.

Air conditioning

HYUNDAI Air Conditioning Systems are filled with R-134a or R-1234yf refrigerant.

1. Start the engine. Push the air conditioning button.
2. Select the Face Level  mode.
3. Set the air intake control to Recirculation mode temporarily to allow the cabin to cool quickly. When the desired temperature in the cabin is reached, change the air intake control back to Fresh mode.
4. Adjust the fan speed control and temperature control to maintain maximum comfort.

NOTICE

When using the air conditioning system, monitor the temperature gauge closely while driving up hills or in heavy traffic when outside temperatures are high. Air conditioning system operation may cause engine overheating. Continue to use the fan but turn the air conditioning system off if the temperature gauge indicates engine overheating.

Air conditioning system operation tips

- If the vehicle has been parked in direct sunlight during hot weather, open the windows for a short time to let the hot air inside the vehicle escape.
- After sufficient cooling has been achieved, switch back from recirculation mode to fresh mode.
- To help reduce moisture inside of the windows on rainy or humid days, decrease the humidity inside the vehicle by operating the air conditioning system with the windows and sunroof closed.
- During air conditioning system operation, you may occasionally notice a slight change in engine speed as the air conditioning compressor cycles. This is a normal system operation characteristic.
- Use the air conditioning system every month for a few minutes to ensure maximum system performance.
- When using the air conditioning system, you may notice clear water dripping (or even puddling) on the ground under the passenger side of the vehicle. This is a normal system operation characteristic.
- If you operate the air conditioner excessively, the difference between the temperature of the outside air and that of the windshield could cause the outer surface of the windshield to fog up, causing loss of visibility. In this case, set the mode selection button to the  position and set the fan speed control knob to the lowest speed setting.

System maintenance

Cabin air filter

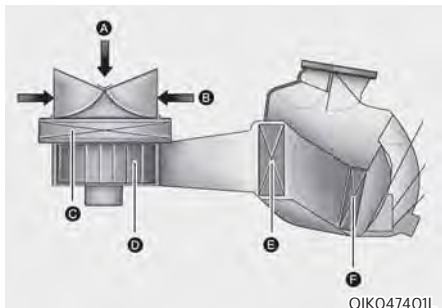

OIK047401L

[A] : Outside air, [B] : Recirculated air

[C] : Cabin air filter, [D] : Blower

[E] : Evaporator core, [F] : Heater core

The climate control air filter installed behind the glove box filters the dust or other pollutants that come into the vehicle from the outside through the heating and air conditioning system.

If dust or other pollutants accumulate in the filter over a period of time, the air flow from the air vents may decrease, resulting in moisture accumulation on the inside of the windshield even when the outside (fresh) air position is selected.

If this happens, we recommend that the climate control air filter be replaced by an authorized HYUNDAI dealer.



Information

- **Replace the filter according to the Maintenance Schedule.**
If the car is being driven in severe conditions such as dusty, rough roads, more frequent climate control air filter inspections and changes are required.
- **When the air flow rate suddenly decreases, we recommend that the system be checked by an authorized HYUNDAI dealer.**

Checking the amount of air conditioner refrigerant and compressor lubricant

When the amount of refrigerant is low, the performance of the air conditioning is reduced. Overfilling also reduces the performance of the air conditioning system.

Therefore, if abnormal operation is found, we recommend that the system be inspected by an authorized HYUNDAI dealer.

NOTICE

It is important that the correct type and amount of oil and refrigerant is used. Otherwise, damage to the compressor and abnormal system operation may occur. To prevent damage, the air conditioning system in your vehicle should only be serviced by trained and certified technicians.



WARNING

Vehicles equipped with R-134a



Since the refrigerant is operated at very high pressure, the air conditioning system should only be serviced by trained and certified technicians.

All refrigerants should be reclaimed with proper equipment.

Venting refrigerants directly to the atmosphere is harmful to individuals and the environment. Failure to heed these warnings can lead to serious injuries.



WARNING

Vehicles equipped with R-1234yf



Since the refrigerant is mildly flammable and operated at high pressure, the air conditioning system should only be serviced by trained and certified technicians. It is important that the correct type and amount of oil and refrigerant are used.



All refrigerants should be reclaimed with proper equipment.



Venting refrigerants directly to the atmosphere is harmful to individuals and the environment. Failure to heed these warnings can lead to serious injuries.

WINDSHIELD DEFROSTING AND DEFOGGING



WARNING

Windshield heating

Do not use the  position during cooling operation in extremely humid weather. The difference between the temperature of the outside air and that of the windshield could cause the outer surface of the windshield to fog up, causing loss of visibility could cause an accident resulting in serious injury or death. In this case, set the mode selection button to the  position and fan speed control knob to a lower speed.

- For maximum defrost performance, set the temperature control to the highest temperature setting and the fan speed control to the highest setting.
- If warm air to the floor is desired while defrosting or defogging, set the mode to the floor-defrost position.
- Before driving, clear all snow and ice from the windshield, rear window, outside rearview mirrors, and all side windows.
- Clear all snow and ice from the hood and air inlet in the cowl grill to improve heater and defroster efficiency and to reduce the probability of fogging up the inside of the windshield.

NOTICE



If the engine temperature is still cold after starting, then a brief engine warm up period may be required for the vented air flow to become warm or hot.

Manual climate control system

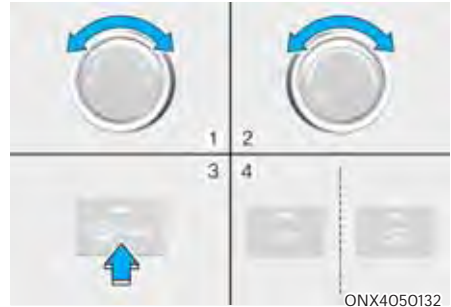
To defog inside windshield



ONX4050132

1. Select any fan speed except “0” position.
2. Select the desired temperature.
3. Press the defroster button (.
4. Fresh mode air will be selected automatically. Additionally, the air conditioning (if equipped) will automatically operate if the mode is selected to the  position.

If the air conditioning and fresh mode are not selected automatically, press the corresponding button manually.

To defrost outside windshield

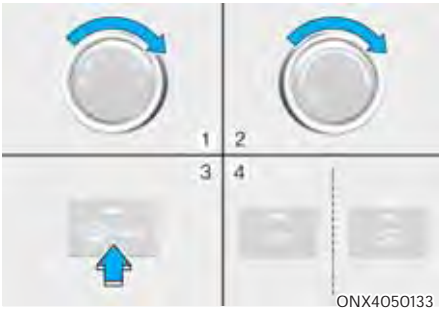

1. Set the fan speed to the highest (extreme right) position.
2. Set the temperature to the extreme hot position.
3. Press the defroster button (☀️).
4. Fresh mode air and air conditioning (if equipped) will be selected automatically.

Automatic climate control system

To defog inside windshield

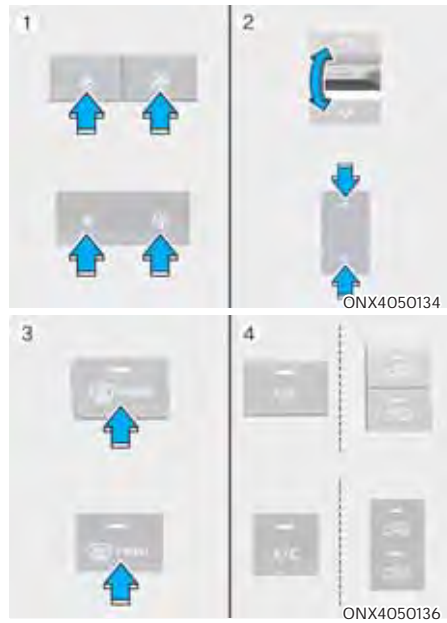

1. Select the desired fan speed.
2. Select the desired temperature.
3. Press the defroster button (☀️).
4. The air-conditioning will turn on according to the detected ambient temperature, fresh mode and higher fan speed will be selected automatically.

If the air-conditioning, fresh mode and higher fan speed are not selected automatically, adjust the corresponding button or knob manually.

If the ☀️ position is selected, lower fan speed is controlled to higher fan speed.

To defrost outside windshield

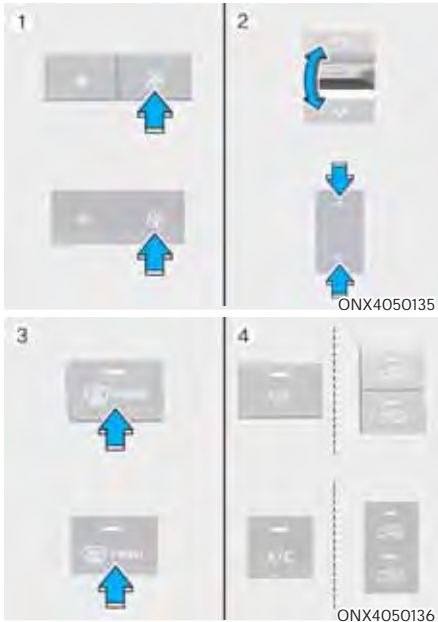

1. Set fan speed to the highest position.
2. Set temperature to the extreme hot (HI) position.
3. Press the defroster button (🌬️).
4. The air-conditioning will turn on according to the detected ambient temperature and fresh mode will be selected automatically.

If the 🌬️ position is selected, lower fan speed is controlled to higher fan speed.

Rear window defroster

NOTICE

To prevent damage to the rear window defroster conducting elements bonded to the inside surface of the rear window, never use sharp instruments or window cleaners containing abrasives to clean the window.



The defroster heats the window to remove frost, fog and thin ice from the interior and exterior of the rear window, while the engine is running.

- To activate the rear window defroster, press the rear window defroster button located in the center control panel. The indicator on the rear window defroster button illuminates when the defroster is ON.
- To turn off the defroster, press the rear window defroster button again.

i Information

- **If there is heavy accumulation of snow on the rear window, brush it off before operating the rear defroster.**
- **The rear window defroster automatically turns off after approximately 20 minutes or when the ignition switch or Engine Start/Stop button is in the OFF position.**

Outside rearview mirror defroster (if equipped)

If your vehicle is equipped with the rearview mirror defrosters, they will operate at the same time you turn on the rear window defroster.

CLIMATE CONTROL ADDITIONAL FEATURES

Auto defogging system (if equipped)



Auto defogging helps reduce the possibility of fogging up the inside of the windshield by automatically sensing the moisture on inside the windshield.

The auto defogging system operates when the heater or air conditioning is on.

i Information

The auto defogging system may not operate normally, when the outside temperature is below -10 °C (14 °F).



When the Auto Defogging System operates, the indicator will illuminate.

If a high amount of humidity is detected in the vehicle, the Auto Defogging System will be enabled. The following steps will be performed automatically:

- Step 1) Air conditioning will turn ON.
- Step 2) Air intake control will change to Fresh mode.
- Step 3) Mode will change to defrost to direct airflow to the windshield.
- Step 4) Fan speed will be set to MAX.

If the air conditioning is off or recirculation mode is manually selected while Auto Defogging System is ON, the Auto Defogging System indicator will blink 3 times to signal that the manual operation has been canceled.

Turning the Auto Defogging System ON or OFF

Climate control system

Press the front windshield defroster button for 3 seconds when the Engine Start/Stop button is in the ON position. When the Auto Defogging System is turned off, the ADS OFF symbol will blink 3 times and ADS OFF will be displayed on the climate control information screen.

When the Auto Defogging System is turned on, the ADS OFF symbol will blink 6 times without a signal.

Infotainment system

Auto Defogging System can be turned on and off by selecting 'Setup → Vehicle Settings → Climate → Defog/Defrost Options → Auto Defog' from the infotainment system screen.

For detailed information, refer to the separately supplied infotainment system manual.



Information

- **When the air conditioning is turned on by Auto Defogging System, if you try to turn off the air conditioning, the indicator will blink 3 times and the air conditioning will not be turned off.**
- **To maintain the effectiveness and efficiency of the Auto Defogging System, do not select Recirculation mode while the system is operating.**
- **When Auto Defogging System is operating, fan speed adjustment, temperature adjustment, and air intake control selection are all disabled.**

NOTICE

Do not remove the sensor cover located on the upper end of the windshield glass.

Damage to system parts could occur and may not be covered by your vehicle warranty.

Auto dehumidify (if equipped)

To increase cabin air quality and reduce windshield misting, recirculation mode switches off automatically after about 5 to 30 minutes, depending on the outside temperature, and the air intake will change to fresh mode.

Turning Auto Dehumidify ON or OFF (if equipped)

Climate control system

To turn the Auto Dehumidify feature on or off, select Face level (👤) mode and press the air intake control (🌀) button at least five times within three seconds while pressing the A/C button. When Auto Dehumidify is turned on, the air intake control button indicator will blink 6 times. When turned off, the indicator will blink 3 times.

Infotainment system

Auto Dehumidify can be turned on and off by selecting 'Setup → Vehicle Settings → Climate → Automatic Ventilation → Auto Dehumidify' from the infotainment system screen.

For detailed information, refer to the separately supplied infotainment system manual.

Recirculating air when washer fluid is used (if equipped)

Recirculation mode automatically activates to reduce any objectionable scent of the washer fluid from entering the cabin when the windshield washer is used.

When it is shifted to the recirculation mode, the unpleasant scent may flow into the vehicle.

However, in cold weather to prevent the windshield from fogging up, the recirculation mode may not be selected.

Turning Activate upon Washer Fluid Use ON or OFF

Climate control system

To turn the Activate upon Washer Fluid Use feature on or off, select Floor level (🚶) mode, and then press the air intake control (👉) button four times within two seconds while pressing the A/C icon.

When Activate upon Washer Fluid Use ON is turned on, the air intake control button indicator will blink 6 times. When turned off, the indicator will blink 3 times.

Infotainment system

Activate upon Washer Fluid Use can be turned on and off by selecting 'Setup → Vehicle Settings → Climate → Recirculate Air → Activate upon Washer Fluid Use (or Interlocking washer fluid)' from the infotainment system screen.

For detailed information, refer to the separately supplied infotainment system manual.

However, in cold weather to prevent the windshield from fogging up, the recirculation mode may not be selected.

Sunroof inside air recirculation (if equipped)

When the sunroof is opened, fresh mode will be automatically selected. At this time, if you press the air intake control button, recirculation mode will be selected but will change back to fresh mode after 3 minutes. When the sunroof is closed, the air intake position will return to the original position that was selected.

Auto. Controls That Use Climate Control Settings (for driver's seat)

The temperature of the driver's seat warmer, air ventilated seat and heated steering wheel is automatically controlled depending on the inside and outside temperature of the vehicle when the engine is running.

To use these features, it must be enabled from the Settings menu in the infotainment system screen. Select:

- Setup → Vehicle Settings → Seat → Heated/Ventilated Features → Heated/Ventilated Features → Auto. Controls That Use Climate Control Settings

For more details on Auto Comfort Control, refer to "Seat Warmers" and "Air ventilation seats" section in chapter 3 and "Heated Steering Wheel" section in chapter 5.

Recirculation Mode Plus (if equipped)

To prevent contaminated air from entering the interior when passing through a tunnel or areas with strong odors, open the driver's seat, passenger seat and rear seat's window about 7 seconds before the vehicle enters the tunnel or when entering the set odor zone, based on the navigation map information and vehicle's speed. This function automatically closes and switches the air conditioner to the best mode.

Depending on the vehicle specifications, you can turn on/off the function in 'Vehicle → Air Conditioning → External Air Blocking → External Air Inflow Prevention Control' of the audio or navigation settings.

Operating conditions

- Road conditions: Expressway, automobile-only road, urban expressway road
- Vehicle conditions: Air conditioner is fresh mode, when the driver's seat, the passenger's seat or rear seat window is opened



CAUTION

- Air inflow prevention control areas may changed through navigation updates to maintain fresh internal air condition.
- Due to GPS errors and vehicle speed errors, the system operation timing may be slightly different.
- If there is a continuous tunnel, the function is not activated again.
- As it operates in indoor circulation mode when entering the tunnel, a rim of fog may occur. Press front windshield defrost button to remove it.
- After exiting the tunnel, you can switch to the air intake mode according to the internal air condition.
- The function does not work for very short tunnels under 50m.
- The function may not work if the GPS is not working correctly.

STORAGE COMPARTMENT

WARNING

Never store cigarette lighters, propane cylinders, or other flammable/explosive materials in the vehicle. These items may catch fire and/or explode if the vehicle is exposed to hot temperatures for extended periods.

WARNING

ALWAYS keep the storage compartment covers closed securely while driving. Items inside your vehicle are moving as fast as the vehicle. If you have to stop or turn quickly, or if there is a crash, the items may fly out of the compartment and may cause an injury if they strike the driver or a passenger.

NOTICE

To avoid possible theft, do not leave valuables in the storage compartments.

Center console storage



To open:
Press the button.

Glove box



To open:
Pull the lever.

WARNING

ALWAYS close the glove box door after use.

An open glove box door can cause serious injury to the passenger in an accident, even if the passenger is wearing a seat belt.

Luggage tray (if equipped)



You can place a first aid kit, a reflector triangle (front tray), tools, etc., in the box for easy access.

- Grasp the strap on the top of the cover and lift it.

INTERIOR FEATURES

Cup holder

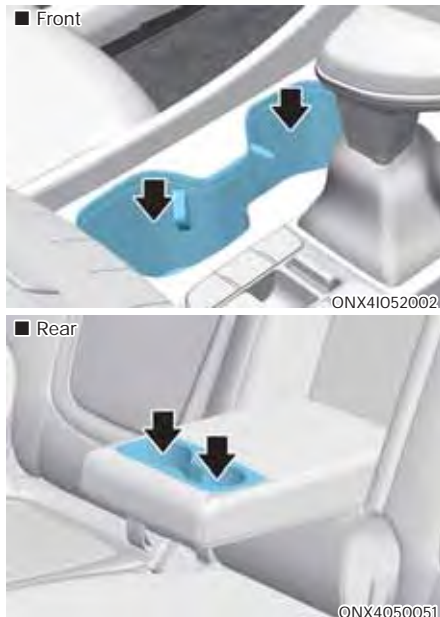

Cups or small beverages cups may be placed in the cup holders.



WARNING

- Avoid abrupt starting and braking when the cup holder is in use to prevent spilling your drink. If hot liquid spills, you could be burned. Such a burn to the driver could cause loss of vehicle control resulting in an accident.
- Do not place uncovered or unsecured cups, bottles, cans, etc., in the cup holder containing hot liquid while the vehicle is in motion. Injuries may result in the event of a sudden stop or collision.
- Only use soft cups in the cup holders. Hard objects can injure you in an accident.



WARNING

Keep cans or bottles out of direct sun light and do not put them in a hot vehicle. It may explode.

NOTICE

- Keep your drinks sealed while driving to prevent spilling your drink. If liquid spills, it may get into the vehicle's electrical/electronic system and damage electrical/electronic parts.
- When cleaning spilled liquids do not use hot air to blow out or dry the cup holder. This may damage the interior.

Sunvisor



To use the sunvisor, pull it downward. To use the sunvisor to block the sun from the side window, pull it downward, release it from the bracket (1) and swing it to the side (2) towards the window. To use the vanity mirror, pull down the sunvisor and slide the mirror cover (3). Adjust the sunvisor forward or backward (4) as needed (if equipped). Use the ticket holder (5) to hold tickets. Close the vanity mirror cover securely and return the sunvisor to its original position after use.

WARNING

For your safety, do not block your view when using the sunvisor.

NOTICE

The tab (5) adjacent to the vanity mirror on the sunvisor can be used for toll road tickets or self parking tickets. Use caution when inserting tickets into the ticket holder to avoid damage. Refrain from putting several tickets in the ticket holder as this could damage the retaining tab.

Power outlet



The power outlet is designed to provide power for mobile telephones or other devices designed to operate with vehicle electrical systems. The devices should draw less than 180 watts with the engine running.



WARNING

Avoid electrical shocks. Do not place your fingers or foreign objects (pin, etc.) into a power outlet or touch the power outlet with a wet hand.



CAUTION

To prevent damage to the power outlets:

- Use the power outlet only when the engine is running and remove the accessory plug after use. Using the accessory plug for prolonged periods of time with the engine off could cause the battery to discharge.
- Only use 12 volts electric accessories which are less than 180 watts in electric capacity.
- Adjust the air-conditioner or heater to the lowest operating level when using the power outlet.
- Close the cover when not in use.
- Some electronic devices can cause electronic interference when plugged into a vehicle's power outlet. These devices may cause excessive audio static and malfunctions in other electronic systems or devices used in your vehicle.
- Push the plug in as far as it will go. If good contact is not made, the plug may overheat and the fuse may open.
- Plug in battery equipped electrical/electronic devices with reverse current protection. The current from the battery may flow into the vehicle's electrical/electronic system and cause system malfunction.

USB charger



The USB charger is designed to recharge batteries of small size electrical devices using a USB cable.

The electrical devices can be recharged when the ignition switch or Engine Start/Stop button is in the ACC or ON (or START) position.

The battery charging state may be monitored on the electrical device.

Disconnect the USB cable from the USB port after use.

- A smart phone or a tablet PC may get warmer during the re-charging process. It does not indicate any malfunction with the charging system.
- A smart phone or a tablet PC, which adopts a different re-charging method, may not be properly re-charged. In this case, use an exclusive charger of your device.
- The charging terminal is only to recharge a device. Do not use the charging terminal either to turn ON an audio or to play media In the infotainment system.

Wireless smart phone charging system (if equipped)



[A] : Indicator light, [B] : Charging pad

On certain models, the vehicle comes equipped with a wireless smart phone charger.

The system is available when all doors are closed, and when the ignition switch or Engine Start/Stop button is in the ON (or START) position.

Charging smart phone

The wireless smart phone charging system charges only the Qi-enabled smart phones (Qi). Read the label on the smart phone accessory cover or visit your smart phone manufacturer's website to check whether your smart phone supports the Qi technology.

The wireless charging process starts when you put a Qi-enabled smart phone on the wireless charging unit.

1. Remove other items, including the remote key or smart key, from the wireless charging unit. If not, the wireless charging process may be interrupted. Place the smart phone on the center of the charging pad.
2. The indicator light is orange when the smart phone is charging. The indicator light will turn blue when phone charging is complete.
3. You can turn ON or OFF the wireless charging function from the Settings menu on the instrument cluster.
Select:
 - Setup → User settings → Convenience → Wireless Charging

If your smart phone is not charging:

- Slightly change the position of the smart phone on the charging pad.
- Make sure the indicator light is orange.

The indicator light will blink orange for 10 seconds if there is a malfunction in the wireless charging system.

In this case, temporarily stop the charging process, and re-attempt to charge your smart phone again.

The system warns you with a message on the LCD display if the smart phone is still on the wireless charging unit after the vehicle is turned OFF and the front door is opened.

For some manufacturer's smart phones, the system may not warn you even though the smart phone is left on the wireless charging unit. This is due to the particular characteristic of the smart phone and not a malfunction of the wireless charging.

NOTICE

- The wireless smart phone charging system may not support certain smart phones, which are not verified for the Qi specification (Qi).
- When placing your smart phone on the charging pad, position the phone in the middle of the mat for optimal charging performance. If your smart phone is off to the side, the charging rate may be less and in some cases the smart phone may experience higher heat conduction.
- In some cases, the wireless charging may stop temporarily when the remote key or smart key is used, either when starting the vehicle or locking/unlocking the doors, etc.
- When charging certain smart phones, the charging indicator may not change to blue when the smart phone is fully charged.
- The wireless charging process may temporarily stop, when temperature abnormally increases inside the wireless smart phone charging system. The wireless charging process restarts, when temperature falls to a certain level.
- The wireless charging process may temporarily stop when there is any metallic item, such as a coin, between the wireless smart phone charging system and smart phone.

- When charging some smart phones with a self-protection feature, the wireless charging speed may decrease and the wireless charging may stop.
- If the smart phone has a thick cover, the wireless charging may not be possible.
- If the smart phone is not completely contacting the charging pad, wireless charging may not operate properly.
- Some magnetic items like credit cards, phone cards or rail tickets may be damaged if left with the smart phone during the charging process.
- When any smart phone without a wireless charging function or a metallic object is placed on the charging pad, a small noise may sound. This small sound is due to the vehicle discerning compatibility of the object placed on the charging pad. It does not affect your vehicle or the smart phone in any way.

Information

If the ignition switch or Engine Start/Stop button is in the OFF position, the charging also stops.

Clock

The clock can be set from the infotainment system.

For detailed information, refer to the separately supplied infotainment system manual.



WARNING

Do not attempt to adjust the clock while driving. Doing so may result in distracted driving which may lead to an accident involving personal injury or death.

Coat hook



These hooks are not designed to hold large or heavy items.



WARNING



Do not hang other objects such as hangers or hard objects except clothes. Also, do not put heavy, sharp or breakable objects in the clothes pockets. In an accident or when the curtain air bag is inflated, it may cause vehicle damage or personal injury.

Floor mat anchor(s)

ALWAYS use the Floor Mat Anchors to attach the front floor mats to the vehicle. The anchors on the front floor carpet keep the floor mats from sliding forward.



WARNING

Do not overlay additional mats or liners over the floor mats. If using All Weather mats, remove the carpeted floor mats before installing them. Only use floor mats designed to connect to the anchors.

⚠️ WARNING

The following must be observed when installing ANY floor mat to the vehicle.

- Ensure to remove a protective film attached on the carpet before attaching a floor mat on the front floor carpet. Otherwise, the floor mat may move freely on the protective film and it could result in unintentional braking or acceleration.
- Ensure that the floor mats are securely attached to the vehicle's floor mat anchor(s) before driving the vehicle.
- Do not use ANY floor mat that cannot be firmly attached to the vehicle's floor mat anchors.
- Do not stack floor mats on top of one another (for example, all-weather rubber mat on top of a carpeted floor mat). Only a single floor mat should be installed in each position.

IMPORTANT - Your vehicle was manufactured with driver's side floor mat anchors that are designed to securely hold the floor mat in place. To avoid any interference with pedal operation, HYUNDAI recommends that the HYUNDAI floor mat designed for use in your vehicle be installed.

Side curtain (if equipped)



To use the side curtain:

1. Lift the curtain by the hook (1).
2. Hang the curtain on both sides of the hook.

⚠️ CAUTION

- Always hang both sides of the curtain on the hook. This could cause damage to the side curtain if only one side of the curtain is hooked.
- Do not let any foreign material get in between the vehicle and side curtain. The side curtain may not be lifted up.

Luggage net holder



To keep items from shifting in the luggage compartment, you can use the 4 holders located in the luggage side trim to attach the luggage net.

Make sure the luggage net is securely attached to the holders in the luggage board.

If necessary, we recommend that you contact your authorized HYUNDAI dealer to obtain a luggage net.



WARNING

Avoid eye injury. DO NOT overstretch the luggage net. ALWAYS keep your face and body out of the luggage net's recoil path. DO NOT use the luggage net when the strap has visible signs of wear or damage.

Use the luggage net to keep only light items from shifting in the luggage compartment.

Cargo security screen (if equipped)



Use the cargo security screen to cover items stored in the cargo area.

Using the cargo security screen



1. Pull the cargo security screen towards the rear of the vehicle by the handle (1).
2. Insert the guide pin (2) into the guide (3).



Information

Pull out the cargo security screen with the handle in the center to prevent the guide pin from falling out of the guide.

When the cargo security screen is not in use:

1. Pull the cargo security screen backward and up to release it from the guides.
2. The cargo security screen will automatically slide back in.

i Information

The cargo security screen may not automatically slide back in if the cargo security screen is not fully pulled out. Pull the cargo screen out all the way and then slowly allow the screen to retract back in.

NOTICE

Since the cargo security screen may be damaged or malformed, do not put luggage on it when it is used.

⚠ WARNING

- Do not place objects on the cargo security screen. Such objects may be thrown about inside the vehicle and possibly injure vehicle occupants during an accident or when braking.
- Never allow anyone to ride in the luggage compartment. It is designed for luggage only.
- Maintain the balance of the vehicle and locate the weight as forward as possible.

Removing the cargo security screen



1. Push one side of the cargo screen inward to compress the spring and release the screen from the vehicle.
2. While the spring is compressed, pull out the cargo security screen.
3. Open the luggage tray and keep the cargo security screen in the tray.

Roof rack



If the vehicle has a roof rack, you can load cargo on top of your vehicle.

NOTICE

If the vehicle is equipped with a sunroof, be sure not to position cargo onto the roof rack in such a way that it could interfere with sunroof operation.

NOTICE

- When carrying cargo on the roof rack, take the necessary precautions to make sure the cargo does not damage the roof of the vehicle.
- When carrying large objects on the roof rack, make sure they do not exceed the overall roof length or width.



WARNING

- The following specification is the maximum weight that can be loaded onto the roof rack.

Distribute the load as evenly as possible onto the roof rack and secure the load firmly.

ROOF RACK	100 kg (220 lbs.) EVENLY DISTRIBUTED
-----------	---

Loading cargo or luggage in excess of the specified weight limit on the roof rack may damage your vehicle.

- The vehicle center of gravity will be higher when items are loaded onto the roof rack.
Avoid sudden starts, braking, sharp turns, abrupt maneuvers or high speeds that may result in loss of vehicle control or rollover resulting in an accident.
- Always drive slowly and turn corners carefully when carrying items on the roof rack.
Severe wind updrafts, caused by passing vehicles or natural causes, can cause sudden upward pressure on items loaded on the roof rack. This is especially true when carrying large, flat items such as wood panels or mattresses.
This could cause the items to fall off the roof rack and cause damage to your vehicle or others around you.
- To prevent damage or loss of cargo while driving, check frequently before or while driving to make sure the items on the roof rack are securely fastened.

INFOTAINMENT SYSTEM

NOTICE

- If you install an aftermarket HID head lamp, your vehicle's audio and electronic devices may not function properly.
- Prevent chemicals such as perfume, cosmetic oil, sun cream, hand cleaner, and air freshener from contacting the interior parts because they may cause damage or discoloration.

USB Port



You can use a USB cable to connect audio devices to the vehicle USB port.

i Information

When using a portable audio device connected to the power outlet, noise may occur during playback. If this happens, use the portable audio device's power source.

Antenna

Shark fin antenna



The roof antenna transmits and receives wireless signals such as AM/FM, GNSS etc.

The signals which antenna can transmit and receive vary by the vehicle option.

Steering wheel remote controls



NOTICE

Do not operate multiple audio remote control buttons simultaneously.

VOLUME (VOL + / VOL -) (1)

- Rotate the VOLUME scroll up to increase volume.
- Rotate the VOLUME scroll down to decrease volume.

SEEK/PRESET (∧ / ∨) (2)

If the SEEK/PRESET switch is pressed up or down and held for 0.8 second or more, it will function in the following modes:

- **RADIO mode**
It will function as the AUTO SEEK select button. It will SEEK until you release the button.
- **MEDIA mode**
It will function as the FF/RW button.

If the SEEK/PRESET switch is pressed up or down, it will function in the following modes:

- **RADIO mode**
It will function as the PRESET STATION UP/DOWN button.
- **MEDIA mode**
It will function as the TRACK UP/DOWN button.

MODE (3)

Press the MODE button to toggle through Radio or Media modes.

MUTE (M) (4)

- Press the MUTE button to mute the sound.
- Press the MUTE button again to activate the sound.

 Information

Detailed information for audio control buttons are described in the following pages in this chapter or in a separately supplied infotainment system manual.

Infotainment system (if equipped)

For detailed information, refer to the separately supplied infotainment system manual.

Voice recognition (if equipped)

For detailed information, refer to the separately supplied infotainment system manual.

Bluetooth® Wireless Technology

■ Type A



OCN7050075

■ Type B



ONX4050062



©NX4E050174

- (1) Call / Answer button
- (2) Call end button
- (3) Microphone

- Audio : For detailed information, refer to “AUDIO” in this chapter.
- Navigation : Detailed information for the Bluetooth® Wireless Technology hands-free is described in the manual supplied separately



CAUTION

To avoid driver distractions, do not excessively operate the device while driving the vehicle which may lead to an accident.

How vehicle radio works

FM reception

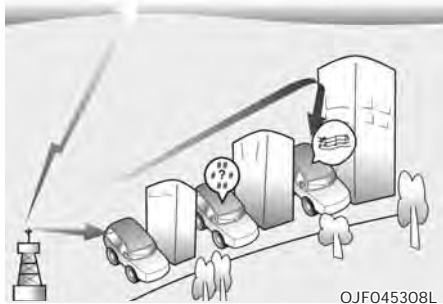

OJF045308L

AM and FM radio signals are broadcast from transmitter towers located around your city. They are intercepted by the radio antenna on your vehicle. This signal is then received by the radio and sent to your vehicle speakers.

When a strong radio signal has reached your vehicle, the precise engineering of your audio system ensures the best possible quality reproduction. However, in some cases the signal coming to your vehicle may not be strong and clear.

This can be due to factors, such as the distance from the radio station, closeness of other strong radio stations or the presence of buildings, bridges or other large obstructions in the area.

AM (MW, LW) reception



AM broadcasts can be received at greater distances than FM broadcasts. This is because AM radio waves are transmitted at low frequencies. These long, low frequency radio waves can follow the curvature of the earth rather than travelling straight out into the atmosphere.

In addition, they curve around obstructions so that they can provide better signal coverage.

FM radio station

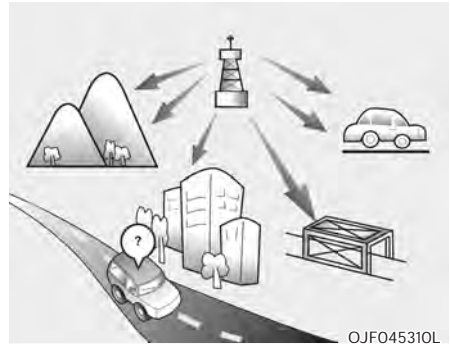

FM broadcasts are transmitted at high frequencies and do not bend to follow the earth's surface. Because of this, FM broadcasts generally begin to fade at short distances from the station. Also, FM signals are easily affected by buildings, mountains, or other obstructions. These can result in certain listening conditions which might lead you to believe a problem exists with your radio.

The following conditions are normal and do not indicate radio trouble :

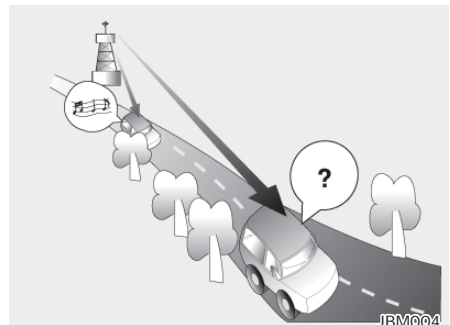

- **Fading** - As your vehicle moves away from the radio station, the signal will weaken and sound will begin to fade. When this occurs, we suggest that you select another stronger station.

- Flutter/Static - Weak FM signals or large obstructions between the transmitter and your radio can disturb the signal causing static or fluttering noises to occur. Reducing the treble level may lessen this effect until the disturbance clears.

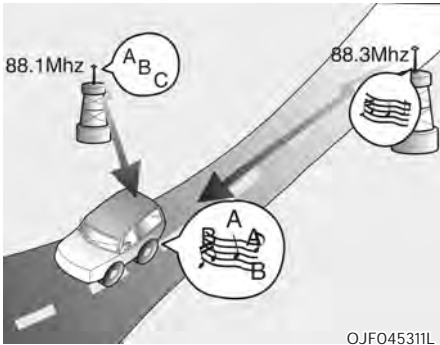

- Station Swapping - As a FM signal weakens, another more powerful signal near the same frequency may begin to play. This is because your radio is designed to lock onto the clearest signal. If this occurs, select another station with a stronger signal.
- Multi-Path Cancellation - Radio signals being received from several directions can cause distortion or fluttering. This can be caused by a direct and reflected signal from the same station, or by signals from two stations with close frequencies. If this occurs, select another station until the condition has passed.

Using a cellular phone or a twoway radio

When a cellular phone is used inside the vehicle, noise may be produced from the audio system. This does not mean that something is wrong with the audio equipment. In such a case, use the cellular phone at a place as far as possible from the audio equipment.

NOTICE

When using a communication system such as a cellular phone or a radio set inside the vehicle, a separate external antenna must be fitted. When a cellular phone or a radio set is used with an internal antenna alone, it may interfere with the vehicle's electrical system and adversely affect safe operation of the vehicle.



WARNING

Do not use a cellular phone while driving. Stop at a safe location to use a cellular phone.

iPod®

iPod® is a registered trademark of Apple Inc.

Bluetooth® Wireless Technology

The Bluetooth® word mark and logos are registered trademarks owned by Bluetooth SIG, Inc. and any use of such marks by HYUNDAI is under license.

Other trademarks and trade names are those of their respective owners.

A Bluetooth® Wireless Technology enabled cell phone is required to use Bluetooth® Wireless Technology.



6. Driving Your Vehicle

Before driving.....	6-4
Before entering the vehicle	6-4
Before starting.....	6-4
Ignition switch.....	6-5
Key ignition switch	6-5
Engine Start/Stop button.....	6-9
Automatic transmission	6-15
Parking	6-19
Good driving practices.....	6-20
Braking system.....	6-21
Power-assist brakes	6-21
Disc brakes wear indicator	6-21
Electronic Parking Brake (EPB).....	6-22
Auto Hold	6-26
Anti-lock Brake System (ABS).....	6-30
Electronic Stability Control (ESC)	6-31
Vehicle Stability Management (VSM)	6-34
Trailer Stability Assist (TSA)	6-35
Hill-Start Assist Control (HAC).....	6-35
Emergency Stop Signal (ESS)	6-36
Brake Assist System (BAS)	6-36
Downhill Brake Control (DBC).....	6-37
Good braking practices.....	6-39
Four Wheel Drive (4WD) selection	6-40
Emergency precautions.....	6-43
Reducing the risk of a rollover.....	6-45
Drive Mode Integrated Control System (2WD)	6-47
Drive Mode Integrated Control System (4WD)	6-51
Drive mode	6-51
Multi terrain mode	6-53

Special driving conditions.....	6-54
Hazardous driving conditions	6-54
Rocking the vehicle.....	6-54
Smooth cornering	6-55
Driving at night.....	6-55
Driving in the rain	6-55
Driving in flooded areas.....	6-56
Highway driving	6-56
Reducing the risk of a rollover.....	6-56
Winter driving.....	6-57
Snow or icy conditions.....	6-57
Winter precautions.....	6-60
Trailer towing.....	6-62
If you decide to pull a trailer?	6-63
Trailer towing equipment.....	6-66
Driving with a trailer	6-67
Maintenance when towing a trailer	6-70
Vehicle weight.....	6-71
Overloading	6-71

**WARNING**

Carbon monoxide (CO) gas is toxic. Breathing CO can cause unconsciousness and death.

Engine exhaust contains carbon monoxide which cannot be seen or smelled.

Do not inhale engine exhaust.

If at any time you smell engine exhaust inside the vehicle, open the windows immediately. Exposure to CO can cause unconsciousness and death by asphyxiation.

Be sure the exhaust system does not leak.

The exhaust system should be checked whenever the vehicle is raised to change the oil or for any other purpose. If you hear a change in the sound of the exhaust or if you drive over something that strikes the underneath side of the vehicle, we recommend that the exhaust system be checked as soon as possible by an authorized HYUNDAI dealer.

Do not run the engine in an enclosed area.

Letting the engine idle in your garage, even with the garage door open, is a hazardous practice. Run the engine only long enough to start the engine and to move the vehicle out of the garage.

Avoid idling the engine for prolonged periods with people inside the vehicle.

If it is necessary to idle the engine for a prolonged period with people inside the vehicle, be sure to do so only in an open area with the air intake set at "Fresh" and fan control set to high so fresh air is drawn into the interior.

Keep the air intakes clear.

To assure proper operation of the ventilation system, keep the ventilation air intakes located in front of the windshield clear of snow, ice, leaves, or other obstructions.

If you must drive with the tailgate open:

Close all windows.

Open instrument panel air vents.

Set the air intake control at "Fresh", the air flow control at "Floor" or "Face", and the fan control set to high.

BEFORE DRIVING

Before entering the vehicle

- Be sure all windows, outside mirror(s), and outside lights are clean and unobstructed.
- Remove frost, snow, or ice.
- Visually check the tires for uneven wear and damage.
- Check under the vehicle for any sign of leaks.
- Be sure there are no obstacles behind you if you intend to back up.

Before starting

- Make sure the hood, the tailgate, and the doors are securely closed and locked.
- Adjust the position of the seat and steering wheel.
- Adjust the inside and outside rearview mirrors.
- Verify all the lights work.
- Fasten your seat belt. Check that all passengers have fastened their seat belts.
- Check the gauges and indicators in the instrument panel and the messages on the instrument display when the ignition switch is in the ON position.
- Check that any items you are carrying are stored properly or fastened down securely.



WARNING

To reduce the risk of **SERIOUS INJURY** or **DEATH**, take the following precautions:

- **ALWAYS** wear your seat belt. All passengers must be properly belted whenever the vehicle is moving. For more information, refer to “Seat Belts” section in chapter 3.
- Always drive defensively. Assume other drivers or pedestrians may be careless and make mistakes.
- Stay focused on the task of driving. Driver distraction can cause accidents.
- Leave plenty of space between you and the vehicle in front of you.



WARNING

NEVER drink or take drugs and drive.

Drinking or taking drugs and driving is dangerous and may result in an accident and **SERIOUS INJURY** or **DEATH**.

Drunk driving is the number one contributor to the highway death toll each year. Even a small amount of alcohol will affect your reflexes, perceptions and judgment. Just one drink can reduce your ability to respond to changing conditions and emergencies and your reaction time gets worse with each additional drink.

Driving while under the influence of drugs is as dangerous as or more dangerous than driving under the influence of alcohol.

You are much more likely to have a serious accident if you drink or take drugs and drive. If you are drinking or taking drugs, don't drive. Do not ride with a driver who has been drinking or taking drugs. Choose a designated driver or call a taxi.

IGNITION SWITCH



WARNING

To reduce the risk of **SERIOUS INJURY** or **DEATH**, take the following precautions:

- **NEVER** allow children or any person who is unfamiliar with the vehicle to touch the ignition switch or related parts. Unexpected and sudden vehicle movement can occur.
- **NEVER** reach through the steering wheel for the ignition switch, or any other control, while the vehicle is in motion. The presence of your hand or arm in this area may cause a loss of vehicle control resulting in an accident.

Key ignition switch

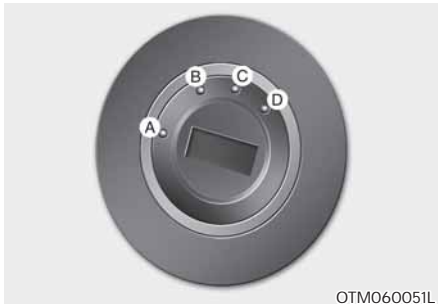

OTM060051L

[A] : LOCK, [B] : ACC

[C] : ON, [D] : START

Whenever the front door is opened, the ignition switch will illuminate, provided the ignition switch is not in the ON position. The light will go off immediately when the ignition switch is turned on or go off after about 30 seconds when the door is closed.



WARNING

- **NEVER** turn the ignition switch to the LOCK or ACC position while the vehicle is in motion except in an emergency.
This will result in the engine turning off and loss of power assist for the steering and brake systems. This may lead to loss of directional control and braking function, which could cause an accident.
- Before leaving the driver's seat, always make sure the vehicle is in P (Park) gear (for automatic transmission vehicle), apply the parking brake, and turn the ignition switch to the LOCK position.
Unexpected vehicle movement may occur if these precautions are not followed.

NOTICE

Never use aftermarket keyhole covers. This may generate start-up failure due to communication failure.

Key ignition switch positions

Switch Position	Action	Notes
LOCK	To turn the ignition switch to the LOCK position, push the key in at the ACC position and turn the key towards the LOCK position. The ignition key can be removed in the LOCK position. The steering wheel locks to protect the vehicle from theft.	
ACC	Some electrical accessories are usable. The steering wheel unlocks.	If difficulty is experienced turning the ignition switch to the ACC position, turn the key while turning the steering wheel right and left to release.
ON	This is the normal key position when the engine has started. All features and accessories are usable. The warning lights can be checked when you turn the ignition switch from ACC to ON.	Do not leave the ignition switch in the ON position when the engine is not running to prevent the battery from discharging.
START	To start the engine, turn the ignition switch to the START position. The switch returns to the ON position when you let go of the key.	The engine will crank until you release the key.

Starting the engine



WARNING

- Always wear appropriate shoes when operating your vehicle. Unsuitable shoes, such as high heels, ski boots, sandals, flip-flops, etc., may interfere with your ability to use the brake, accelerator and clutch pedals.
- Do not start the vehicle with the accelerator pedal depressed. The vehicle can move which can lead to an accident.
- Wait until the engine rpm is normal. The vehicle may suddenly move if the brake pedal is released when the rpm is high.

Starting the gasoline engine

Vehicle with Automatic transmission:

1. Make sure the parking brake is applied.
2. Make sure the gear is shifted to P (Park).
3. Depress the brake pedal.
4. Turn the ignition switch to the START position. Hold the key (maximum of 10 seconds) until the engine starts and release it.

i Information

- **Do not wait for the engine to warm up while the vehicle remains stationary. Start driving at moderate engine speeds. (Steep accelerating and decelerating should be avoided.)**
- **Always start the vehicle with your foot on the brake pedal. Do not depress the accelerator while starting the vehicle. Do not race the engine while warming it up.**

NOTICE

To prevent damage to the vehicle:

- Do not hold the ignition key in the START position for more than 10 seconds. Wait 5 to 10 seconds before trying again.
- Do not turn the ignition switch to the START position with the engine running. It may damage the starter.
- If traffic and road conditions permit, you may put the gear in N (Neutral) while the vehicle is still moving and turn the ignition switch to the START position in an attempt to restart the engine.
- Do not push or tow your vehicle to start the engine.

Starting the diesel engine

To start the diesel engine when the engine is cold, it has to be pre-heated before starting the engine and then have to be warmed up before starting to drive.

Vehicle with Automatic transmission:

1. Make sure the parking brake is applied.
2. Make sure the gear is shifted to P (Park).
3. Depress the brake pedal.
4. Turn the ignition switch to the ON position to pre-heat the engine. The glow indicator light (🔥) will illuminate.
5. When the glow indicator light (🔥) goes out, turn the key ignition switch to the START position. Hold the key (maximum of 10 seconds) until the engine starts and release it.

NOTICE

If the engine does not start within 10 seconds after preheating is completed, turn the ignition switch once more to the LOCK position and wait for 10 seconds. Then turn the ignition switch to the ON position in order to preheat the engine again.

Starting and stopping the engine for turbocharger intercooler

1. Do not race or accelerate the engine immediately after starting the engine. If the engine is cold, idle for several seconds before sufficient lubrication is ensured in the turbo charger unit.
2. After high speed or extended driving that requires heavy engine load, idle the engine about 1 minute before turning the engine off. This idle time will allow the turbocharger to cool prior to shutting the engine off.

NOTICE

Do not turn off the engine immediately after it has been subjected to a heavy load. Doing so may cause severe damage to the engine or turbo charger unit.

NOTICE

To prevent damage to the vehicle:

- Do not hold the ignition key in the START position for more than 10 seconds. Wait 5 to 10 seconds before trying again.
- Do not turn the ignition switch to the START position with the engine running. It may damage the starter.
- If traffic and road conditions permit, you may put the gear in N (Neutral) while the vehicle is still moving and turn the ignition switch to the START position in an attempt to restart the engine.
- Do not push or tow your vehicle to start the engine.

Engine Start/Stop button (if equipped)



ONX4E060042R

Whenever the front door is opened, the Engine Start/Stop button will illuminate and will go off 30 seconds after the door is closed.

WARNING

To turn the vehicle off in an emergency:
Press and hold the Engine Start/Stop button for more than two seconds OR Rapidly press and release the Engine Start/Stop button three times (within three seconds).

If the vehicle is still moving, you can restart the vehicle without depressing the brake pedal by pressing the Engine Start/Stop button with the gear in the N (Neutral) position.

WARNING

- NEVER press the Engine Start/Stop button while the vehicle is in motion except in an emergency. This will result in the vehicle turning off and loss of power assist for the steering and brake systems. This may lead to loss of directional control and braking function, which could cause an accident.
- Before leaving the driver's seat, always make sure the gear is in the P (Park) position, set the parking brake, press the Engine Start/Stop button to the OFF position, and take the Smart Key with you. Unexpected vehicle movement may occur if these precautions are not followed.
- NEVER reach through the steering wheel for the Engine Start/Stop button or any other control while the vehicle is in motion. The presence of your hand or arm in this area may cause a loss of vehicle control resulting in an accident.

Engine Stop/Start button positions - Vehicle with automatic transmission

Button Position	Action	Notes
OFF	To turn off the engine, press the Engine Start/Stop button with the vehicle shifted to P (Park). Note if the Engine Start/Stop button is pressed with the vehicle shifted to D (Drive) or R (Reverse), the gear will automatically shift to P (Park). If the Engine Start/Stop button is pressed with the gear shifted to N (Neutral), the Engine Start/Stop button will change to the ACC position. The steering wheel locks to protect the vehicle from theft.	If the steering wheel is not locked properly when you open the driver's door, the warning chime will sound.
ACC	Press the Engine Start/Stop button when the button is in the OFF position without depressing the brake pedal. Some of the electrical accessories are usable. The steering wheel unlocks.	<ul style="list-style-type: none"> • If you leave the Engine Start/Stop button in the ACC position for more than one hour, the battery power will turn off automatically to prevent the battery from discharging. • If the steering wheel doesn't unlock properly, the Engine Start/Stop button will not work. Press the Engine Start/Stop button while turning the steering wheel right and left to release.
ON	Press the Engine Start/Stop button while it is in the ACC position without depressing the brake pedal. The warning lights can be checked before the engine is started.	Do not leave the Engine Start/Stop button in the ON position when the engine is not running to prevent the battery from discharging.
START	To start the engine, depress the brake pedal and press the Engine Start/ Stop button with the gear shifted to the P (Park) or the N (Neutral) position. For your safety, start the engine with the gear shifted to the P (Park) position.	If you press the Engine Start/Stop button without depressing the brake pedal, the engine does not start and the Engine Start/Stop button changes as follows: OFF → ACC → ON → OFF or ACC

Starting the engine



WARNING

- Always wear appropriate shoes when operating your vehicle. Unsuitable shoes, such as high heels, ski boots, sandals, flipflops, etc., may interfere with your ability to use the brake and accelerator pedals.
- Do not start the vehicle with the accelerator pedal depressed.
The vehicle can move which can lead to an accident.
- Wait until the engine rpm is normal. The vehicle may suddenly move if the brake pedal is released when the rpm is high.



Information

- **The vehicle will start by pressing the Engine Start/Stop button, only when the smart key is in the vehicle.**
- When if the smart key is in the vehicle, if it is far away from the driver, the engine may not start.
- When the Engine Start/Stop button is in the ACC or ON position, if any door is open, the system checks for the smart key. When the smart key is not in the vehicle, the “” indicator will blink and the warning 'Key not in vehicle' will come on. When all doors are closed, the chime will also sound for about 5 seconds. Keep the smart key in the vehicle.



Starting the gasoline engine

Vehicle with Automatic transmission:

1. Always carry the smart key with you.
2. Make sure the parking brake is applied.
3. Make sure the gear is shifted to P (Park).
4. Depress the brake pedal.
5. Press the Engine Start/Stop button.



Information

- **Do not wait for the engine to warm up while the vehicle remains stationary.**
Start driving at moderate engine speeds. Steep accelerating and decelerating should be avoided.
- **Always start the vehicle with your foot on the brake pedal. Do not depress the accelerator while starting the vehicle. Do not race the engine while warming it up.**

Starting the diesel engine

To start the diesel engine when the engine is cold, it has to be pre-heated and then it has to be warmed up, before starting to drive.

If you press the ENGINE START/STOP button to the START position without depressing the brake pedal and clutch pedal, the engine will not start, and it will be displayed on the cluster as in the following pop-up.



When the shift lever is not placed in N (Neutral), the following pop-up will be displayed on the cluster.

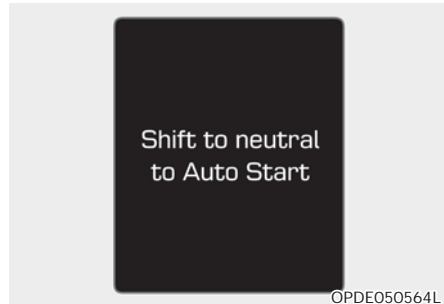

Vehicle with Automatic transmission:

1. Always carry the smart key with you.
2. Make sure the parking brake is applied.
3. Make sure the gear is shifted to P (Park).
4. Depress the brake pedal.
5. Press the Engine Start/Stop button.
6. Continue depressing the brake pedal until the glow indicator light (⏏) goes out.
7. When the glow indicator light (⏏) goes out, the engine will start.

Information

If the Engine Start/Stop button is pressed while the engine is pre-heating, the engine may start.

Starting and stopping the engine with turbocharger intercooler

1. Do not race or accelerate the engine immediately after starting the engine. If the engine is cold, idle for several seconds before sufficient lubrication is ensured in the turbo charger unit.
2. After high speed or extended driving that requires heavy engine load, idle the engine about 1 minute before turning the engine off. This idle time will allow the turbocharger to cool prior to shutting the engine off.

NOTICE

Do not turn off the engine immediately after it has been subjected to a heavy load. Doing so may cause severe damage to the engine or turbo charger unit.

NOTICE

To prevent damage to the vehicle:

- If the engine stalls while you are in motion, do not attempt to shift the gear to the P (Park) position.
If traffic and road conditions permit, you may put the gear in N (Neutral) while the vehicle is still moving and press the Engine Start/Stop button in an attempt to restart the engine.
- Do not push or tow your vehicle to start the vehicle.

NOTICE

To prevent damage to the vehicle:

Do not press the Engine Start/Stop button for more than 10 seconds except when the stop lamp fuse is blown.

When the stop lamp fuse is blown, you cannot start the engine in the normal way. Replace the fuse with a new one. If you are not able to replace the fuse, you can start the engine by pressing and holding the Engine Start/Stop button for 10 seconds with the Engine Start/Stop button in the ACC position.

For your safety always depress the brake pedal before starting the vehicle.



i Information

If the smart key battery is weak or the smart key does not work correctly, you can start the vehicle by pressing the Engine Start/Stop button with the smart key in the direction of the picture above.

Turning off the engine

1. Stop the vehicle and depress the brake pedal fully.
2. Make sure the gear is shifted to P (Park).
3. Press the Engine Start/Stop button to the OFF position and apply the parking brake.

Remote start (if equipped)



You can start the vehicle using the Remote Start button of the smart key.

To start the vehicle remotely:

1. Press the door lock button within 10 m (32 feet) from the vehicle.
 2. Press the remote start (HOLD) button for over 2 seconds within 4 seconds after locking the doors.
 3. To turn off the remote start function, press the remote start (HOLD) button once.
- The remote start (HOLD) button may not operate if the smart key is not within 10 m (32 feet).
 - The vehicle will not remotely start if the engine hood or tailgate is opened.
 - The vehicle must be in P (Park) for the remote start function to start.
 - The engine turns off if you get in the vehicle without a registered smart key.
 - The engine turns off if you do not get in the vehicle within 10 minutes after remotely starting the vehicle.
 - Do not idle the engine for a long period.

AUTOMATIC TRANSMISSION

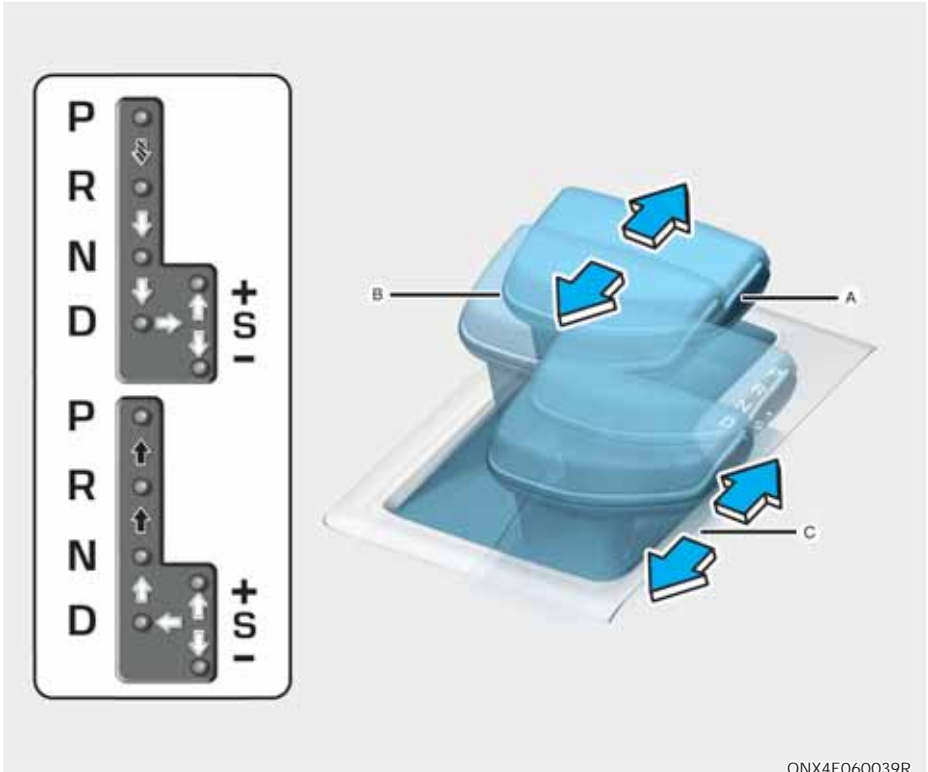

ONX4E060039R

[A] : Shift lever, [B] : Shift release button, [C] : Manual shift mode

 Depress the brake pedal and press the Shift release button while moving the shift lever.

 Press the Shift release button while moving the shift lever.

 The shift lever can freely operate.

The indicator in the instrument cluster displays the shift lever position when the ignition switch is in the ON position.

 **WARNING**

To reduce the risk of serious injury or death:

- **ALWAYS check the surrounding areas near your vehicle for people, especially children, before shifting a vehicle into D (Drive) or R (Reverse).**
- **Before leaving the driver's seat, always make sure the vehicle is shifted to the P (Park) position, then set the parking brake, and place the ignition switch or Engine Start/Stop button in the LOCK/OFF position. Unexpected and sudden vehicle movement can occur if these precautions are not followed.**

Transmission ranges

The indicator in the instrument cluster displays the shift lever/button position when the ignition switch is in the ON position.

P (Park)

Always come to a complete stop before shifting into P (Park).

To shift from P (Park), you must depress firmly on the brake pedal and make sure your foot is off the accelerator pedal.

If you have done all of the above and still cannot shift the lever out of P (Park), see "Shift-Lock Release" in this chapter. (shift lever type)

The shift lever/button must be in P (Park) before turning the engine off.

 **WARNING**

- **Shifting into P (Park) while the vehicle is in motion may cause you to lose control of the vehicle.**
- **After the vehicle has stopped, always make sure the vehicle is in P (Park), apply the parking brake, and turn the engine off.**
- **When parking on an incline, shift the gear to P (Park) and apply the parking brake to prevent the vehicle from rolling downhill.**
- **Do not use the P (Park) position in place of the parking brake.**

R (Reverse)

Use this position to drive the vehicle backward.

NOTICE

Always come to a complete stop before shifting into or out of R (Reverse); you may damage the transmission if you shift into R (Reverse) while the vehicle is in motion.

N (Neutral)

The wheels and transmission are not engaged.

Use N (Neutral) if you need to restart a stalled engine, or if it is necessary to stop with the engine ON. Shift into P (Park) if you need to leave your vehicle for any reason.

Always depress the brake pedal when you are shifting from N (Neutral) to another gear.

**WARNING**

Do not shift into gear unless your foot is firmly on the brake pedal. Shifting into gear when the engine is running at high speed can cause the vehicle to move very rapidly. You could lose control of the vehicle and hit people or objects.

D (Drive)

This is the normal driving position. The transmission will automatically shift through a 6(or 8)-gear sequence, providing the best fuel economy and power.

Then depress the accelerator pedal smoothly.

For extra power when passing another vehicle or driving uphill, depress the accelerator more. Then, the transmission will automatically downshift to the next lower gear (or gears, as appropriate).

The DRIVE MODE switch, allows the driver to switch from NORMAL mode to SPORT or ECO mode.

For more Details, refer to "Drive Mode Integrated Control System" later in this chapter.

NOTICE

With the gear in N (Neutral) the Engine Start/Stop button will be in the ACC position. Note that the doors cannot be locked in the ACC position or the battery may discharge if left in the ACC position for a long period.



OCN7060007AU

DS mode (Drive Sporty)

To shift into Ds mode, move the shift lever from D (Drive) to the center of the manual shift mode. The engine and transmission control logic is automatically optimized for sporty driving.

In Ds mode, if you move the shift lever to + (up) or - (down), the gear will change to manual shift mode. If the shift lever is moved back into D (Drive), it will change to D (Drive). The vehicle will perform according to the mode selected from drive mode (NORMAL, ECO, SPORT).

Shift-lock release

If the shift lever cannot be moved from the P (Park) position into R (Reverse) position with the brake pedal depressed, continue depressing the brake, and then do the following:



ONX4E060037R

1. Place the ignition switch in the LOCK/OFF position.
2. Apply the parking brake.
3. Carefully remove the shift lever boots.
4. Move the Shift lever while holding the release button (1) with a tool (for example, flathead screw-driver).

If you need to use the shift-lock release, we recommend that the system be inspected by an authorized HYUNDAI dealer immediately.

Shift-lock system

For your safety, the automatic transmission has a shift-lock system which prevents shifting the transmission from P (Park) into R (Reverse) unless the brake pedal is depressed.

To shift the transmission from P (Park) into R (Reverse):

1. Depress and hold the brake pedal.
2. Start the engine or place the ignition switch in the ON position.
3. Depress the brake pedal and move the shift lever to R (Reverse).

Parking

Always come to a complete stop and continue to depress the brake pedal. Shift the gear to P (Park), apply the parking brake, and place the ignition switch or Engine Start/Stop button in the LOCK/OFF position. Take the Key with you when exiting the vehicle.



WARNING

When you stay in the vehicle with the engine running, be careful not to depress the accelerator pedal for a long period of time. The engine or exhaust system may overheat and start a fire.

The exhaust gas and the exhaust system are very hot. Keep away from the exhaust system components.

Do not stop or park over flammable materials, such as dry grass, paper or leaves. They may ignite and cause a fire.

Good driving practices

- Never shift the gear from P (Park) or N (Neutral) to any other position with the accelerator pedal depressed.
- Never shift the gear into P (Park) when the vehicle is in motion.

Be sure the vehicle is completely stopped before you attempt to shift into R (Reverse) or D (Drive).

- Do not shift the gear to N (Neutral) when driving. If the gear is shifted to N (Neutral) while driving, the vehicle loses the ability to provide engine braking. Doing so may increase the risk of an accident. Also, shift the gear back to D (Drive) while the vehicle is moving may severely damage the transmission.
- Driving uphill or downhill, always shift to D (Drive) when driving forward or to R (Reverse) when driving backwards, and check the gear position indicated on the cluster before driving. If you drive in the opposite direction of the selected gear, the engine will turn off and a serious accident might be occurred due to the degraded brake performance.
- Do not drive with your foot resting on the brake pedal. Even light, but consistent pedal pressure can result in the brakes overheating, brake wear and possibly even brake failure.
- When driving in manual shift mode, slow down before shifting to a lower gear. Otherwise, the lower gear may not be engaged if the engine rpms are outside of the allowable range.
- Always apply the parking brake when leaving the vehicle. Do not depend on placing the transmission in P (Park) to keep the vehicle from moving.

- Exercise extreme caution when driving on a slippery surface. Be especially careful when braking, accelerating or shifting gears. On a slippery surface, an abrupt change in vehicle speed can cause the drive wheels to lose traction and may cause loss of vehicle control resulting in an accident.
- Optimum vehicle performance and economy is obtained by smoothly depressing and releasing the accelerator.



WARNING

To reduce the risk of **SERIOUS INJURY** or **DEATH**:

- **ALWAYS wear your seatbelt. In a collision, an unbelted occupant is significantly more likely to be seriously injured or killed than a properly belted occupant.**
- **Avoid high speeds when cornering or turning.**
- **Do not make quick steering wheel movements, such as sharp lane changes or fast, sharp turns.**
- **The risk of rollover is greatly increased if you lose control of your vehicle at highway speeds.**
- **Loss of control often occurs if two or more wheels drop off the roadway and the driver over steers to reenter the roadway.**
- **In the event your vehicle leaves the roadway, do not steer sharply. Instead, slow down before pulling back into the travel lanes.**
- **HYUNDAI recommends you follow all posted speed limits.**

BRAKING SYSTEM

Power-assist brakes

Your vehicle has power-assisted brakes that adjust automatically through normal usage.

If the engine is not running or is turned off while driving, the power assist for the brakes will not work. You can still stop your vehicle by applying greater force to the brake pedal than typical. The stopping distance, however, will be longer than with power brakes.

When the engine is not running, the reserve brake power is partially depleted each time the brake pedal is applied. Do not pump the brake pedal when the power assist has been interrupted.



Information

- **When the brake pedal is depressed under certain driving conditions or weather conditions, you may temporarily hear a noise. This is normal and does not indicate a problem with your brakes.**
- **While driving on a road with deicing chemicals, brake noise or abnormal tire wear may occur due to deicing chemicals. In a safe traffic condition, additionally apply the brakes to remove deicing chemicals on the brake discs and pads.**



WARNING

Take the following precautions:

- Do not drive with your foot resting on the brake pedal. This will create abnormal high brake temperatures, excessive brake lining and pad wear, and increased stopping distances.

- When descending down a long or steep hill, downshift to a lower gear in order to control your speed without using the brake pedal excessively. Applying the brakes continuously will cause the brakes to overheat and could result in a temporary loss of braking performance.
- Wet brakes may impair the vehicle's ability to safely slow down; the vehicle may also pull to one side when the brakes are applied. Applying the brakes lightly will indicate whether they have been affected in this way. Always test your brakes in this fashion after driving through deep water. To dry the brakes, lightly tap the brake pedal to heat up the brakes while maintaining a safe forward speed until brake performance returns to normal. Avoid driving at high speeds until the brakes function correctly.

Disc brakes wear indicator

When your brake pads are worn and new pads are required, you will hear a high pitched warning sound from your front or rear brakes. You may hear this sound come and go or it may occur whenever you depress the brake pedal.

NOTICE

To avoid costly brake repairs, do not continue to drive with worn brake pads.



Information

Always replace brake pads as complete front or rear axle sets.

Electronic Parking Brake (EPB)

Applying the parking brake

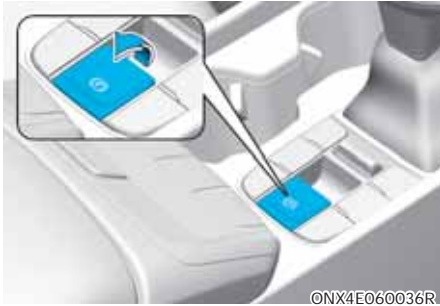

To apply EPB (Electronic Parking Brake):

1. Depress and hold the brake pedal.
2. Pull up the EPB switch.

Make sure the Parking Brake warning light comes on.

EPB (Electronic Parking Brake) may be automatically applied when:

- Requested by other systems
- The driver turns the vehicle off while Auto Hold is operating.

Emergency braking

If there is a problem with the brake pedal while driving, emergency braking is possible by pulling up and holding the EPB switch. Braking is possible only while you are holding the EPB switch. However, braking distance will be longer than normal.

WARNING

To reduce the risk of **SERIOUS INJURY** or **DEATH**, do not operate the EPB while the vehicle is moving except in an emergency situation. It could damage the brake system and lead to an accident.

Information

During emergency braking, the Parking Brake warning light will illuminate to indicate that the system is operating.

NOTICE

If you continuously notice a noise or burning smell when the EPB is used for emergency braking, we recommend that you have the system checked by an authorized HYUNDAI dealer.

Releasing the parking brake



To release EPB (Electronic Parking Brake):

1. Press the ignition switch or Engine Start/Stop button to the ON or START position.
2. Press the EPB switch while depressing the brake pedal.

Make sure the Parking Brake warning light goes off.

To release EPB (Electronic Parking Brake) automatically:

- Gear in P (Park) (vehicle equipped with shift lever)
With the engine running depress the brake pedal and shift out of P (Park) to R (Reverse) or D (Drive).
- Gear in N (Neutral) (vehicle equipped with shift lever)
With the engine running depress the brake pedal and shift out of N (Neutral) to R (Reverse) or D (Drive).

Make sure the Parking Brake warning light goes off.

i Information

- For your safety, you can engage EPB even though the Engine Stop/Start button is in the OFF position (only if battery power is available), but you cannot release it.
- For your safety, depress the brake pedal and release the parking brake manually with the EPB switch when you drive downhill or when backing up the vehicle.

NOTICE

- If the Parking Brake warning light is still on even though the EPB has been released, we recommend that you have the system checked by an authorized HYUNDAI dealer.
- Do not drive your vehicle with EPB applied. It may cause excessive brake pad and brake rotor wear.

Warning messages



To release EPB, fasten seatbelt, close door, hood and tailgate

- If you try to drive with EPB applied, a warning will sound and a message will appear.
- If the driver's seat belt is unfastened and the engine hood or tailgate is opened, a warning will sound and a message will appear.
- If there is a problem with the vehicle, a warning may sound and a message may appear.

If the situation occurs, depress the brake pedal and release EPB by pressing the EPB switch.

WARNING

- Whenever leaving the vehicle or parking, always come to a complete stop and continue to depress the brake pedal.

Shift the gear into P (Park), pull up the EPB switch, and press the ignition switch or Engine Start/Stop button to the LOCK/OFF position. Take the Key with you when leaving the vehicle.

Vehicles not fully engaged in P (Park) with the parking brake set are at risk for moving inadvertently and causing injury to yourself or others.

- NEVER allow anyone who is unfamiliar with the vehicle to touch the EPB switch. If EPB is released unintentionally, serious injury may occur.
- Only release EPB when you are seated inside the vehicle with your foot firmly on the brake pedal.

NOTICE

- Do not apply the accelerator pedal while the parking brake is engaged. If you depress the accelerator pedal with EPB engaged, a warning will sound and a message will appear. Damage to the parking brake may occur.
- Driving with the parking brake on can overheat the braking system and cause premature wear or damage to brake parts. Make sure EPB is released and the Parking Brake warning light is off before driving.

Information

- A clicking sound may be heard while operating or releasing the EPB. These conditions are normal and indicate that EPB is functioning properly.
- When leaving your keys with a parking attendant or assistant, make sure to inform him/her how to operate EPB.

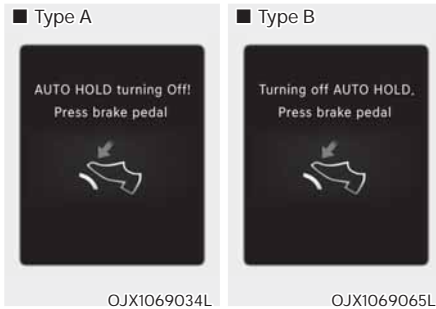

AUTO HOLD turning Off! Press brake pedal /Turning off AUTO HOLD. Press brake pedal

When the conversion from Auto Hold to EPB is not working properly a warning will sound and a message will appear.

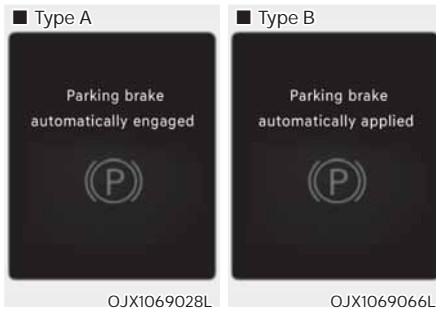

Parking brake automatically engaged / Parking brake automatically applied

When EPB is applied while Auto Hold is activated, a warning will sound and a message will appear.

EPB malfunction

Electronic Parking Brake (EPB) warning light illuminates if the ignition switch or Engine Start/Stop button is pressed to the ON position and goes off in approximately 3 seconds if the system is operating normally.

If the EPB warning light remains on, comes on while driving, or does not come on when the ignition switch or Engine Start/Stop button is pressed to the ON position, this indicates that the EPB may have malfunctioned.

If this occurs, we recommend that you have the system checked by an authorized HYUNDAI dealer.

The EPB warning light may illuminate when the ESC indicator comes on to indicate that ESC is not working properly, but it does not indicate a malfunction of EPB.

NOTICE

- If the EPB warning light is still on, we recommend that you have the system checked by an authorized HYUNDAI dealer.
- If the Parking Brake warning light does not illuminate or blinks even though the EPB switch was pulled up, EPB may not be applied.
- If the Parking Brake warning light blinks when the EPB warning light is on, press the switch, and then pull it up. Repeat this one more time. If the EPB warning does not go off, we recommend that you have the system checked by an authorized HYUNDAI dealer.

Parking brake warning light

- Type A Check the Parking Brake Warning Light by placing the ignition switch or Engine Start/Stop button to the ON position (do not start the engine).
- Type B



This light will be illuminated when the parking brake is applied with the Engine Stop/Start button in the START or ON position.

Before driving, be sure the parking brake is released and the Parking Brake warning light is OFF.

If the Parking Brake warning light remains on after the parking brake is released while the engine is running, there may be a malfunction in the brake system. Immediate attention is necessary.

If at all possible, cease driving the vehicle immediately. If that is not possible, use extreme caution while operating the vehicle and only continue to drive the vehicle until you can reach a safe location.

When the EPB (Electronic Parking Brake) does not release

If the EPB does not release normally, we recommend that you contact an authorized HYUNDAI dealer by loading the vehicle on a flatbed tow truck and have the system checked.

Auto Hold

Auto Hold maintains the vehicle in a standstill even though the brake pedal is not depressed after the driver brings the vehicle to a complete stop by depressing the brake pedal.

To apply:



1. With the driver's door, engine hood and tailgate (vehicle equipped with shift button) closed, depress the brake pedal and then press the AUTO HOLD switch. The white AUTO HOLD indicator will come on and the system will be in the standby position.



2. When you stop the vehicle completely by depressing the brake pedal, Auto Hold maintains the brake pressure to hold the vehicle stationary. The indicator changes from white to green.
3. The vehicle will remain stationary even if you release the brake pedal.
4. If EPB is applied, Auto Hold will be released.

To release:

If you depress the accelerator pedal with the gear in D (Drive) or Manual shift mode or R (Reverse), the Auto Hold will be released automatically and the vehicle will start to move. The AUTO HOLD indicator changes from green to white.

⚠ WARNING

When Auto Hold is automatically released by depressing the accelerator pedal, always take a look around your vehicle.

Slowly depress the accelerator pedal for a smooth start.

To cancel:



1. Depress and hold the brake pedal.
 2. Press the AUTO HOLD switch.
- The AUTO HOLD indicator will turn off.

⚠ WARNING

To prevent, unexpected and sudden vehicle movement, **ALWAYS** press your foot on the brake pedal to cancel the Auto Hold before you:

- Drive downhill.
- Drive the vehicle in R (Reverse).
- Park the vehicle.

i Information

- The Auto Hold does not operate when:
 - The driver's door is opened
 - The engine hood is opened
 - The tailgate is opened
 - The gear is in P (Park)
 - The gear is in P (Park) or R (Reverse)
 - EPB is applied
- For your safety, the Auto Hold automatically switches to EPB when:
 - The driver's door is opened
 - The engine hood is opened
 - The vehicle is in a standstill for more than 10 minutes
 - The vehicle is standing on a steep slope
 - The vehicle moved several times

In these cases, the Parking Brake warning light comes on, the AUTO HOLD indicator changes from green to white, and a warning sound and a message will appear to inform you that EPB has been automatically engaged. Before driving off again, depress the brake pedal, check the surrounding area near your vehicle and release the parking brake manually with the EPB switch.

- While operating Auto Hold, you may hear mechanical noise. However, it is normal operating noise.
- If the vehicle is restarted with the Auto Hold system in the standby position or operating, the Auto hold system will continue to operate in the standby position.

NOTICE

If the AUTO HOLD indicator changes to yellow, Auto Hold is not working properly. We recommend that you contact an authorized HYUNDAI dealer.



WARNING

- Depress the accelerator pedal slowly when you start the vehicle.
- For your safety, cancel Auto Hold when you drive downhill, back up the vehicle or park the vehicle.

NOTICE

If there is a malfunction with the driver's door or engine hood open detection system, Auto Hold may not work properly.

We recommend that you contact an authorized HYUNDAI dealer.

Warning messages

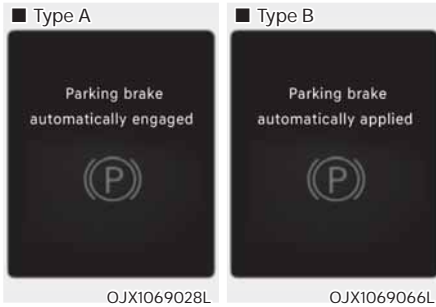

Parking brake automatically engaged / Parking brake automatically applied

When EPB is applied while Auto Hold is activated, a warning will sound and a message will appear.

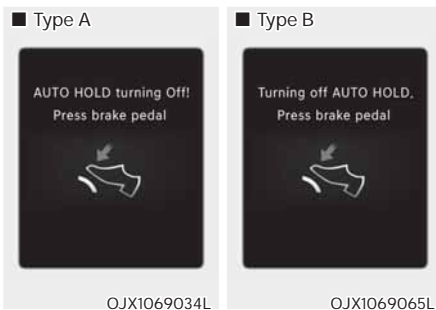

AUTO HOLD turning Off! Press brake pedal /Turning off AUTO HOLD. Press brake pedal

When the conversion from Auto Hold to EPB is not working properly a warning will sound and a message will appear.

When this message is displayed, Auto Hold and EPB may not operate. For your safety, depress the brake pedal.

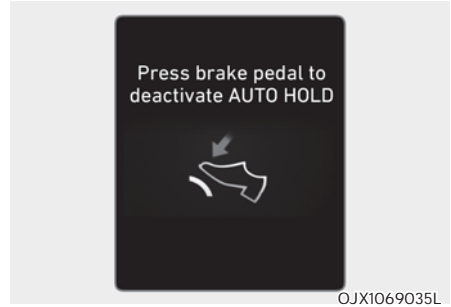

Press brake pedal to deactivate AUTO HOLD

If you did not apply the brake pedal when you release Auto Hold by pressing the AUTO HOLD switch, a warning will sound and a message will appear.



AUTO HOLD conditions not met. Close door, hood and tailgate.

When you press the AUTO HOLD switch, if the driver's door and engine hood are not closed, a warning will sound and a message will appear on the cluster LCD display.

Press the AUTO HOLD switch after closing the driver's door and hood.

Anti-lock Brake System (ABS)



WARNING

Anti-Lock Braking System (ABS) or Electronic Stability Control (ESC) system will not prevent accidents due to improper or dangerous driving maneuvers. Even though vehicle control is improved during emergency braking, always maintain a safe distance between you and objects ahead of you. Vehicle speeds should always be reduced during extreme road conditions. The braking distance for vehicles equipped with ABS or ESC may be longer than for those without these systems in the following road conditions.

Drive your vehicle at reduced speeds during the following conditions:

- Rough, gravel or snow-covered roads.
- On roads where the road surface is pitted or has different surface height.
- Tire chains are installed on your vehicle.

The safety features of ABS or ESC equipped vehicle should not be tested by high speed driving or cornering. This could endanger the safety of yourself or others.

ABS is an electronic braking system that helps prevent a braking skid. ABS allows the driver to steer and brake at the same time.

Using ABS

To obtain the maximum benefit from your ABS in an emergency situation, do not attempt to modulate your brake pressure and do not try to pump your brakes. Depress your brake pedal as hard as possible.

When you apply your brakes under conditions which may lock the wheels, you may hear sounds from the brakes, or feel a corresponding sensation in the brake pedal. This is normal and it means your ABS is active.

ABS does not reduce the time or distance it takes to stop the vehicle.

Always maintain a safe distance from the vehicle in front of you.

ABS will not prevent a skid that results from sudden changes in direction, such as trying to take a corner too fast or making a sudden lane change. Always drive at a safe speed for the road and weather conditions.

ABS cannot prevent a loss of stability. Always steer moderately when braking hard. Severe or sharp steering wheel movement can still cause your vehicle to veer into oncoming traffic or off the road.

On loose or uneven road surfaces, operation of the anti-lock brake system may result in a longer stopping distance than for vehicles equipped with a conventional brake system.

The ABS ((ABS)) warning light will stay on for several seconds after the ignition switch or Engine Start/Stop button is in the ON position.

During that time, ABS will go through self-diagnosis and the light will go off if everything is normal. If the light stays on, you may have a problem with your ABS. We recommend that you contact an authorized HYUNDAI dealer as soon as possible.



WARNING

If the ABS ((ABS)) warning light is on and stays on, you may have a problem with the ABS. Your power brakes will work normally. To reduce the risk of serious injury or death, we recommend you to contact the nearest authorized HYUNDAI dealer as soon as possible.

NOTICE

When you drive on a road having poor traction, such as an icy road, and apply your brakes continuously, ABS will be active continuously and the ABS ((ABS)) warning light may illuminate. Pull your vehicle over to a safe place and turn the vehicle off.

Restart the vehicle. If the ABS warning light is off, then your ABS system is normal.

Otherwise, you may have a problem with your ABS system. We recommend that you contact an authorized HYUNDAI dealer as soon as possible.



Information

When you jump start your vehicle because of a drained battery, the ABS ((ABS)) warning light may turn on at the same time. This happens because of the low battery voltage. It does not mean your ABS is malfunctioning. Have the battery recharged before driving the vehicle.

Electronic Stability Control (ESC)



Electronic Stability Control helps to stabilize the vehicle during cornering maneuvers.

ESC checks where you are steering and where the vehicle is actually going. ESC applies braking pressure to any one of the vehicle's brakes and intervenes in the engine management system to assist the driver with keeping the vehicle on the intended path. It is not a substitute for safe driving practices. Always adjust your speed and driving to the road conditions.



WARNING

Never drive too fast for the road conditions when cornering. ESC will not prevent accidents.

Excessive speed in turns, abrupt maneuvers, and hydroplaning on wet surfaces can result in severe accidents.

ESC operation

ESC ON condition

When the ignition switch or Engine Start/Stop button is in the ON position, ESC and the ESC OFF indicator lights illuminate for approximately three seconds. After both lights go off, ESC is enabled.

When operating



When ESC is in operation, the ESC indicator light blinks:

- When you apply your brakes under conditions which may lock the wheels, you may hear sounds from the brakes, or feel a corresponding sensation in the brake pedal. This is normal and it means your ESC is active.
- When ESC activates, the engine may not respond to the accelerator as it does under routine conditions.
- If Cruise Control was in use when ESC activates, Cruise Control automatically disengages. Cruise Control can be reengaged when the road conditions allow. See **"Cruise Control System"** section in chapter 7.

- When moving out of the mud or driving on a slippery road, the engine rpm (revolutions per minute) may not increase even if you press the accelerator pedal deeply. This is to maintain the stability and traction of the vehicle and does not indicate a problem.

ESC OFF condition



To cancel ESC operation:

- State 1
Press the ESC OFF button briefly. The ESC OFF indicator light and/or message 'Traction Control disabled' will illuminate. In this state, the traction control function of ESC (engine management) is disabled, but the brake control function of ESC (braking management) still operates.
- State 2
Press and hold the ESC OFF button continuously for more than 3 seconds. The ESC OFF indicator light and/or message 'Traction & Stability Control disabled' illuminates and a warning chime sounds. In this state, both the traction control function of ESC (engine management) and the brake control function of ESC (braking management) are disabled.
If the ignition switch or Engine Start/Stop button is pressed to the OFF position when ESC is off, ESC remains off. Upon restarting the vehicle, ESC will automatically turn on again.

Indicator lights

- ESC indicator light (blinks)



- ESC OFF indicator light (comes on)



When the ignition switch or Engine Start/Stop button is pressed to the ON position, the ESC indicator light illuminates, then goes off if the ESC system is operating normally.

The ESC indicator light blinks whenever ESC is operating.

If the ESC indicator light stays on, your vehicle may have a malfunction with the ESC system. When this warning light illuminates we recommend that the vehicle be checked by an authorized HYUNDAI dealer as soon as possible.

The ESC OFF indicator light comes on when ESC is turned off.



WARNING

When ESC is blinking, this indicates ESC is active:

Drive slowly and NEVER attempt to accelerate. NEVER turn ESC off while the ESC indicator light is blinking or you may lose control of the vehicle resulting in an accident.

NOTICE

Driving with wheels and tires with different sizes may cause the ESC system to malfunction. Before replacing tires, make sure all four tires and wheels are the same size. Never drive the vehicle with different sized wheels and tires installed.

ESC OFF usage

When Driving

The ESC OFF mode should only be used briefly to help free the vehicle if stuck in snow or mud, by temporarily stopping operation of ESC, to maintain wheel torque.

To turn ESC off while driving, press the ESC OFF button while driving on a flat road surface.

NOTICE

To prevent damage to the transmission:

- Do not allow wheel(s) of one axle to spin excessively while the ESC, ABS, and Parking Brake warning lights are displayed. The repairs would not be covered by the vehicle warranty. Reduce engine power and do not spin the wheel(s) excessively while these lights are displayed.
- When operating the vehicle on a dynamometer, make sure ESC is turned off (ESC OFF light illuminated).



Information

Turning ESC off does not affect ABS or standard brake system operation.

Vehicle Stability Management (VSM)

Vehicle Stability Management is a function of the Electronic Stability Control (ESC) system. It helps the vehicle stay stable when accelerating or braking suddenly on wet, slippery and rough roads where traction over the four tires can suddenly become uneven.



WARNING

Take the following precautions when using Vehicle Stability Management:

- **ALWAYS** check the speed and the distance to the vehicle ahead. VSM is not a substitute for safe driving practices.
- Never drive too fast for the road conditions. VSM will not prevent accidents. Excessive speed in bad weather, on slippery and uneven roads can result in severe accidents.

VSM operation

VSM ON condition

VSM operates when:

Electronic Stability Control (ESC) is on.

When operating

When you apply your brakes under conditions which may activate ESC, you may hear sounds from the brakes, or feel a corresponding sensation in the brake pedal. This is normal and it means your VSM is active.



Information

VSM does not operate when:

- **Driving on a banked road such as gradient or incline.**
- **Driving in reverse.**
- **The ESC OFF indicator light is on.**
- **The EPS (Electric power steering) warning light (⚠) is on or blinks.**

VSM OFF condition

To cancel VSM operation, press the ESC OFF button. ESC OFF (OFF) indicator light will illuminate.

To turn on VSM, press the ESC OFF button again. The ESC OFF indicator light will go out.



WARNING

If the ESC (⚠) indicator light or EPS (⚠) warning light stays illuminated or blinks, your vehicle may have a malfunction with the VSM system. When the warning light illuminates we recommend that the vehicle be checked by an authorized HYUNDAI dealer as soon as possible.

NOTICE

Driving with wheels and tires with different sizes may cause the VSM system to malfunction. Before replacing tires, make sure all four tires and wheels are the same size. Never drive the vehicle with different sized tires and wheels installed.

Trailer Stability Assist (TSA)

Trailer stability assist is operated as vehicle stability control system. The trailer stability assist system has an effort to stabilize the vehicle and trailer when the trailer sways or oscillates. There are various reasons making vehicle sway and oscillate. Almost case it happens at high speed however, if the trailer is affected by crosswinds, buffeting, and improper overloading, it may be a risk of swaying.

Factors of swaying such as:

- High speed
- Strong crosswinds
- Improper overloading
- Sudden controlling of steering wheel
- Uneven road

The trailer stability assist system continuously analyzes the vehicle and trailer instability. When the Trailer stability assist system detects some sway, the brakes are applied automatically to stabilize the vehicle on the front wheel. However, if it is not enough to stabilize, the brakes are applied on all wheels automatically and engine power is properly reduced. When the vehicle is stable from swaying, the trailer stability assist system does not operate.

Hill-Start Assist Control (HAC)

Hill-Start Assist Control helps prevent the vehicle from rolling backwards when starting a vehicle from a stop on a hill. The system operates the brakes automatically for approximately 2 seconds and releases when the accelerator pedal is depressed.



WARNING

Always be ready to depress the accelerator pedal when starting off an incline. Hill-Start Assist Control activates only for approximately 2 seconds.



Information

- **Hill-Start Assist Control does not operate when the gear is shifted to P (Park) or N (Neutral).**
- **Hill-Start Assist Control activates even when the ESC (Electronic Stability Control) is off. However, it does not activate, when ESC does not operate normally.**

Emergency Stop Signal (ESS) (if equipped)

Emergency Stop Signal alerts the driver behind by blinking the stop lights, while sharply and severely braking.

The system is activated when:

- The vehicle suddenly stops. (The deceleration power exceeds 7 m/s^2 , and the driving speed exceeds 55 km/h (34 mph).)
- ABS is activated and the driving speed exceeds 55 km/h (34 mph).

The hazard warning flasher automatically turns ON after blinking the stop lights:

- When driving speed is under 40 km/h (25 mph),
- When ABS is deactivated, and
- When the sudden braking situation is over.

The hazard warning flasher turns OFF:

- When the vehicle drives at a low speed for a certain period of time.
The driver can manually turn OFF the hazard warning flasher by pressing the button.

Information

Emergency Stop Signal will not activate, when the hazard warning flashers are already on.

Brake Assist System (BAS)

Brake Assist System is to reduce or to avoid accident risk. It recognizes the distance from the vehicle ahead or the pedestrian through the sensors (for example, radar and camera), and, if necessary, warns the driver of accident risk with the warning message or the warning alarms.

Limitations of the system

Brake Assist System is a supplemental system and is not a substitute for safe driving practices. It is the responsibility of the driver to always check the speed and distance to the vehicle ahead to ensure it is safety to use the AEB system.

Take the following precautions when using Brake Assist System :

This system is only a supplemental system and it is not intended to, nor does it replace the need for extreme care and attention of the driver. The sensing range and objects detectable by the sensors are limited. Pay attention to the road conditions at all times.

NEVER drive too fast in accordance with the road conditions or while cornering.

Always drive cautiously to prevent unexpected and sudden situations from occurring. Brake Assist System does not stop the vehicle completely and does not avoid collisions.

System off

- Brake Assist System is canceled in the following situations:
 - The accelerator pedal is depressed over a certain level.
 - The vehicle stops.
 - ESC (Electronic Stability Control) or electronic devices has malfunctioned.
 - In a situation the system cannot operate normally.
 - Ten seconds have passed since the brake has been controlled automatically by The brake Assist System.



WARNING

- **The brake Assist System decreases vehicle speed after a collision and reduces the risk of a second collision, but it does not prevent a second collision. You may drive away from the collision spot to avoid other dangerous situations by depressing the accelerator pedal.**
- **After the vehicle is stopped by the brake Assist System, the system stops controlling the brakes.**
Depending on the situation, the driver should depress the brake or the accelerator pedal to prevent a further accident.

Downhill Brake Control (DBC) (if equipped)







Downhill Brake Control assists the driver to descend down a steep hill without having to depress the brake pedal.

The system automatically applies the brakes to maintain vehicle speed below a certain speed and allows the driver to concentrate on steering the vehicle down hill.

The system is turned off whenever the engine is turned off.

Press the button to turn on the system and press the button again to turn it off.

System operation

Mode	Indicator	Description
Standby	 Green light on	Press the Downhill Brake Control button when vehicle speed is under 60 km/h (37 mph). Downhill Brake Control will turn on and enter the standby mode. The system does not turn on if vehicle speed is over 60 km/h (37 mph).
Activated	 Green light blink	In the standby mode, Downhill Brake Control will activate under the following conditions: <ul style="list-style-type: none"> • The hill is steep enough. • The brake pedal or accelerator pedal is not depressed. Within the activation speed range 4 ~ 40 km/h (2 ~ 25 mph), the driver can control the vehicle speed by depressing the brake pedal or accelerator pedal.
Deactivated	 Green light off	Downhill Brake Control will turn off under the following conditions: <ul style="list-style-type: none"> • The Downhill Brake Control button is pressed again. • Vehicle speed is over 60 km/h (37 mph).
	 Green light on	Downhill Brake Control will be deactivated but maintain the standby mode under the following conditions: <ul style="list-style-type: none"> • The hill is not steep enough. • Vehicle speed is between 40 ~ 60 km/h (25 ~ 37 mph).
System malfunction	 Yellow light on	The yellow warning light illuminates when the system may have malfunctioned or may not work properly during activation. If this occurs, Downhill Brake Control is deactivated. We recommend that the system be inspected by an authorized HYUNDAI dealer as soon as possible.



Downhill Brake Control disabled. Control vehicle speed (manually)

When Downhill Brake Control is not working properly this warning message will appear on the cluster LCD display and you will hear a warning sound. If this occurs, control vehicle speed by depressing the brake pedal.

⚠️ WARNING

Always turn off Downhill Brake Control on normal roads. The system might activate inadvertently from the standby mode when driving through speed bumps or making sharp curves.

i Information

- **Downhill Brake Control may not deactivate on steep inclines even though the brake pedal or accelerator pedal is depressed.**
- **Downhill Brake Control may not always maintain vehicle speed at a certain speed.**
- **Downhill Brake Control does not operate when:**
 - **The gear is in P (Park).**
 - **ESC is activated.**
- **Noise or vibration may occur from the brakes when Downhill Brake Control is activated.**
- **The rear stop light comes on when Downhill Brake Control is activated.**

Good braking practices

⚠️ WARNING

Whenever leaving the vehicle or parking, always come to a complete stop and continue to depress the brake pedal. Shift the gear to the P (Park) position, then apply the parking brake, and press the ignition switch or Engine Start/Stop button to the OFF position.

Vehicles parked with the parking brake not applied or not fully engaged may roll inadvertently and may cause injury to the driver and others. ALWAYS apply the parking brake before exiting the vehicle.

Wet brakes can be dangerous! The brakes may get wet if the vehicle is driven through standing water or if it is washed. Your vehicle will not stop as quickly if the brakes are wet. Wet brakes may cause the vehicle to pull to one side.

To dry the brakes, apply the brakes lightly until the braking action returns to normal. If the braking action does not return to normal, stop as soon as it is safe to do so and we recommend that you call an authorized HYUNDAI dealer for assistance.

DO NOT drive with your foot resting on the brake pedal. Even light, but constant pedal pressure can result in the brakes overheating, brake wear, and possibly even brake failure.

If a tire goes flat while you are driving, apply the brakes gently and keep the vehicle pointed straight ahead while you slow down. When you are moving slowly enough for it to be safe to do so, pull off the road and stop in a safe location.

Keep your foot firmly on the brake pedal when the vehicle is stopped to prevent the vehicle from rolling forward.

FOUR WHEEL DRIVER (4WD) SELECTION (IF EQUIPPED)



Press the DRIVE/TERRAIN button to change from normal driving mode to multi terrain mode. After the button is pressed, rotate the knob within 4 seconds to select SNOW, MUD or SAND.

Selected mode		Description
Auto AWD (Normal driving)	-	<ul style="list-style-type: none"> Use this mode when driving on normal roads. Under normal operating conditions, the vehicle operates similar to conventional 2WD vehicles. If the system determines there is a need for four wheel drive, the engine's driving power is distributed to all four wheels automatically.
SNOW		<ul style="list-style-type: none"> Use this mode when driving on slippery roads. The engine's driving power is properly distributed to the wheels, to help start the vehicle stably on slippery roads or keep tires from slipping.
MUD		<ul style="list-style-type: none"> Use this mode when driving on muddy, unpaved or uneven roads The engine's driving power is properly distributed to the wheels, to secure sufficient driving force that will help start the vehicle.
SAND		<ul style="list-style-type: none"> Use this mode when driving on smooth, dry sand or deep gravel and unpaved roads. The engine's driving power is properly distributed to the wheels, to help drive safely on smooth, dry sand or deep gravel and unpaved roads.

Be sure to maintain Auto AWD mode when driving on normal roads. If you drive with the Multi Terrain mode on normal roads or curved roads, it may damage AWD parts and cause vibration and noise. However, vibration and noise are normal conditions that will disappear when Auto AWD mode is selected. Also, when the vehicle is changed from Multi Terrain mode (SNOW, MUD or SAND) to Auto AWD, a sensation may be felt as driving power is delivered to the rear wheels.

WARNING

If the AWD warning light stays on the instrument cluster, your vehicle may have a malfunction with the AWD system. Whenever the AWD warning light illuminates we recommend that you consult an authorized HYUNDAI dealer.

For safe AWD operation

Before driving

- Make sure all passengers are wearing seat belts.
- Sit upright and closer to the steering wheel than usual. Adjust the steering wheel to a position comfortable for you to drive.

Driving on snow-covered or icy roads

- Start off slowly by applying the accelerator pedal gently.
- Use snow tires or tire chains.
- Keep sufficient distance between your vehicle and the vehicle in front of you.
- Apply engine braking during deceleration by manually selecting a lower gear.
- Avoid speeding, rapid acceleration, sudden brake applications, and sharp turns to prevent skids.



Information

When using Snow Tires, mount them on all four wheels.

When using tire chains, install them on the rear tires. However, driving speed must be below 30 km/h (20 mph) and minimize the driving distance. High-speed or long-term driving with tire chains installed may malfunction or damage the AWD system.

For more details on Snow Tires and Tire Chains, refer to "Winter Driving" section later in this chapter.

Driving in sand or mud

- Maintain slow and constant speed.
- Use tire chains driving in mud if necessary.
- Keep sufficient distance between your vehicle and the vehicle in front of you.
- Reduce vehicle speed and always check the road condition.
- Avoid speeding, rapid acceleration, sudden brake applications, and sharp turns to prevent getting stuck.

NOTICE

When the vehicle is stuck in snow, sand or mud, place a nonslip material under the drive wheels to provide traction OR slowly spin the wheels in forward and reverse directions which causes a rocking motion that may free the vehicle.

However, avoid running the engine continuously at high rpm, doing so may damage the AWD system.

Driving up or down hills

- Driving uphill
 - Before starting off, check if it is possible to drive uphill.
 - Drive as straight as possible.
- Driving downhill
 - Do not change gear while driving downhill. Select gear before driving downhill.
 - Drive slowly using engine braking while driving downhill.
 - Drive straight as possible.



WARNING

Exercise extreme caution driving up or down steep hills. The vehicle may flip over depending on the grade, terrain, water and mud conditions.



WARNING

Do not drive across the contour of steep hills. A slight change in the wheel angle can destabilize the vehicle, or a stable vehicle may lose stability if the vehicle stops its forward motion. Your vehicle may roll over and lead to a serious injury or death.

Driving through water

- Try to avoid driving in deep standing water. It may stall your engine and clog your exhaust pipes.
- If you need to drive in water, stop your vehicle, set the vehicle in Multi Terrain mode and drive under 8 km/h (5 mph).
- Do not change gear while driving in water.



CAUTION

Always drive slowly in water. If you drive too fast, water may get into the engine compartment and wet the ignition system causing your vehicle to suddenly stop.

Additional driving conditions

- Become familiar with the off-road conditions before driving.
- Always pay attention when driving off-road and avoid dangerous areas.
- Drive slowly when driving in heavy wind.
- Reduce vehicle speed when cornering. The center of gravity of AWD vehicles is higher than conventional 2WD vehicles, making them more likely to roll over when you rapidly turn corners.
- Always hold the steering wheel firmly when you are driving off-road.



WARNING

Do not grab the inside of the steering wheel when you are driving off-road. You may hurt your arm by a sudden steering maneuver or from steering wheel rebound due to an impact with objects on the ground. You could lose control of the steering wheel which may lead to serious injury or death.

Emergency precautions

Tires

When replacing tires, be sure to equip all four tires with the same size, type, tread patterns, brand and load-carrying capacity.



WARNING

Do not use tire and wheel with different size and type from the one originally installed on your vehicle. It can affect the safety and performance of your vehicle, which could lead to steering failure or rollover causing serious injury.

In an emergency situation, a compact spare tire or Tire Mobility Kit may be used. But, do not use the compact spare tire continuously. Repair or replace the original tire as soon as possible to avoid failure of the differential or 4WD system.



WARNING

Never start or run the engine while an 4WD vehicle is raised on a jack. The vehicle can slip or roll off of a jack causing serious injury or death to you or those nearby.

Towing

4WD vehicles must be towed with a wheel lift and dollies or flatbed equipment with all the wheels off the ground. **For more details, refer to "Towing" section in chapter 8.**

Vehicle inspection

- If the vehicle needs to be operated on a vehicle lift do not attempt to stop any of the four wheels from turning. This could damage the 4WD system.
- Never engage the parking brake while running the engine on a car lift. This may damage the 4WD system.

Dynamometer testing

A 4WD vehicle must be tested on a special four wheel chassis dynamometer.

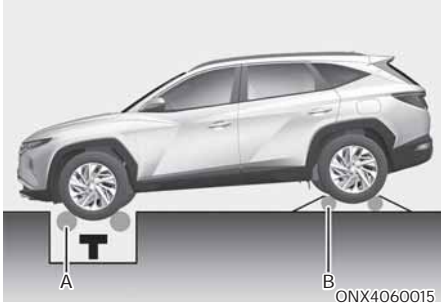

[A] : Roll tester (Speedometer),

[B] : Temporary free roller

An 4WD vehicle should not be tested on a 2WD roll tester. If a 2WD roll tester must be used, perform the following procedure:

1. Check the tire pressures recommended for your vehicle.
2. Place the front wheels on the roll tester for a speedometer test as shown in the illustration.
3. Release the parking brake.
4. Place the rear wheels on the temporary free roller as shown in the illustration.



CAUTION

- Never engage the parking brake while performing the test.
- When the vehicle is lifted up, do not operate the front and rear wheel separately. All four wheels should be operated.



WARNING

Keep away from the front of the vehicle while the vehicle is in gear on the dynamometer. The vehicle can jump forward and cause serious injury or death.

Reducing the risk of a rollover

This multi-purpose passenger vehicle is defined as a Sports Utility Vehicle (SUV). SUV's have higher ground clearance and a narrower track to make them capable of performing in a wide variety of off-road applications. Specific design characteristics give them a higher center of gravity than ordinary vehicles. An advantage of the higher ground clearance is a better view of the road, which allows you to anticipate problems. They are not designed for cornering at the same speeds as conventional passenger vehicles, any more than low-slung sports cars are designed to perform satisfactorily in off-road conditions. Due to this risk, driver and passengers are strongly recommended to buckle their seat belts. In a rollover crash, an unbelted person is more likely to die than a person wearing a seat belt. There are steps that a driver can make to reduce the risk of a rollover. If at all possible, avoid sharp turns or abrupt maneuvers, do not load your roof rack with heavy cargo, and never modify your vehicle in any way.



WARNING

Rollover

As with other Sports Utility Vehicle (SUV), failure to operate this vehicle correctly may result in loss of control, an accident or vehicle rollover.

- **Utility vehicles have a significantly higher rollover rate than other types of vehicles.**
- **Specific design characteristics (higher ground clearance, narrower track, etc.) give this vehicle a higher center of gravity than ordinary vehicles.**
- **A SUV is not designed for cornering at the same speeds as conventional vehicles.**
- **Avoid sharp turns or abrupt maneuvers.**
- **In a rollover crash, an unbelted person is significantly more likely to die than a person wearing a seat belt. Make sure everyone in the vehicle is properly buckled up.**



WARNING

Your vehicle is equipped with tires designed to provide safe ride and handling capability. Do not use a size and type of tire and wheel that is different from the one that is originally installed on your vehicle. It can affect the safety and performance of your vehicle, which could lead to steering failure or rollover and serious injury. When replacing the tires, be sure to equip all four tires with the tire and wheel of the same size, type, tread, brand and load-carrying capacity. If you nevertheless decide to equip your vehicle with any tire/wheel combination not recommended by HYUNDAI for off road driving, you should not use these tires for highway driving.



WARNING

Jacked vehicle

While a full-time 4WD vehicle is being raised on a jack, never start the engine or cause the tires to rotate.

There is a danger that rotating tires touching the ground could cause the vehicle to fall off the jack and to jump forward or rearward.

DRIVE MODE INTEGRATED CONTROL SYSTEM (2WD)



The drive mode may be selected according to the driver's preference or road condition.

The system resets to be in the NORMAL mode, when the engine is restarted.

When the engine is restarted, Drive Mode is set to ECO by default.

i Information

If there is a problem with the instrument cluster, the drive mode will be in NORMAL mode and may not change to SPORT mode.

The mode changes, as below, whenever the DRIVE MODE button is pressed or toggled.

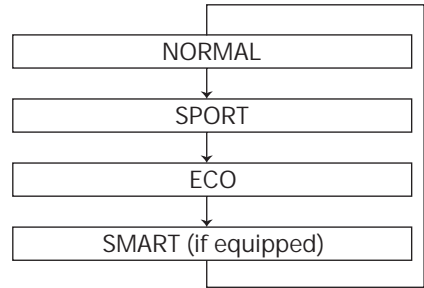

When NORMAL mode is selected, it is not displayed on the instrument cluster.

ECO mode : ECO mode helps improve fuel efficiency for eco-friendly driving.

NORMAL mode : NORMAL mode provides smooth driving and comfortable riding.

SPORT mode : SPORT mode provides sporty but firm riding.

The drive mode will change to NORMAL mode when the engine is restarted.

However, except when it is in ECO mode and SMART mode. ECO mode and SMART mode will be maintained, as selected when the engine is restarted.

ECO mode



When the Drive Mode is set to ECO mode, the engine and transmission control logic are changed to maximize fuel efficiency.

- When the ECO mode is selected by using the DRIVE MODE button, the ECO indicator will illuminate.
- If the vehicle is set to ECO mode, when the engine is turned OFF and restarted, the Drive Mode setting will change to NORMAL mode.

Information

Fuel efficiency depends on the driver's driving habit and road condition.

When ECO mode is activated:

- The acceleration response may be slightly reduced as the accelerator pedal is depressed moderately.
- The air conditioner performance may be limited.
- The shift pattern of the automatic transmission may change.
- The engine noise may get louder.

The above situations are normal conditions when ECO mode is activated, to improve fuel efficiency.

Limitation of ECO mode operation:

If the following conditions occur while ECO mode is operating, the system operation is limited even though there is no change in ECO indicator.

- When driving the vehicle with the automatic transmission gear shift gear in DS mode (Drive Sporty), the system will be limited according to the shift location.

SPORT mode

SPORT

SPORT mode manages the driving dynamics by automatically adjusting the steering effort, the engine and transmission control logic for enhanced driving performance.

- When SPORT mode is selected by using the DRIVE MODE button, the SPORT indicator will illuminate.
- Whenever the engine is restarted, the Drive Mode will revert back to COMFORT mode. If SPORT mode is desired, re-select SPORT mode from the DRIVE MODE button.
- When SPORT mode is activated:
 - The engine rpm will tend to remain raised over a certain length of time even after releasing the accelerator
 - Upshifts are delayed when accelerating

i Information

In SPORT mode, the fuel efficiency may decrease.

i Information

- **When you dynamically drive the vehicle in SMART mode by abruptly decelerating or sharply turning while driving, driving mode changes to SPORT mode.**
- **When you dynamically drive the vehicle in SMART mode by abruptly decelerating or sharply turning the driving mode changes to SPORT mode. However, it may**

SMART mode (if equipped)

SMART

SMART mode selects the proper driving mode among ECO, COMFORT and SPORT by judging the driver's driving habits (for example, mild or dynamic) from the brake pedal depression or the steering wheel operation.

- Press the DRIVE MODE button to activate SMART mode. When SMART mode is activated, the indicator illuminates on the instrument cluster.
- The vehicle starts in SMART mode, when the engine was turned OFF in SMART mode.
- SMART mode automatically controls gear shifting patterns, engine torque, in accordance with the driver's driving habits.

i Information

- **When you mildly drive the vehicle in SMART mode, the driving mode changes to ECO mode to improve fuel efficiency. However, the actual fuel efficiency may differ in accordance with your driving situations (for example, upward/downward slope, vehicle deceleration/acceleration).**
- **When you dynamically drive the vehicle in SMART mode by abruptly decelerating or sharply curving, the driving mode changes to SPORT mode. However, it may adversely affect fuel economy.**

Various driving situations, which you may encounter in SMART mode

- The driving mode automatically changes to ECO mode after a certain period of time, when you gently depress the accelerator pedal (Your driving is categorized to be mild.).
- The driving mode automatically changes from SMART ECO mode to SMART SPORT mode after a certain period of time, when you sharply or repetitively depress the accelerator pedal.
- The driving mode automatically changes to SMART SPORT mode with the same driving patterns, when the vehicle starts to drive on an upward slope of a certain angle. The driving mode automatically returns to SMART ECO mode, when the vehicle enters a leveled road.
- The driving mode automatically changes to SMART SPORT, when you abruptly accelerate the vehicle or repetitively operate the steering wheel (Your driving is categorized to be sporty.). In this mode, your vehicle drives in a lower gear for abrupt accelerating/decelerating and increases the engine brake performance.
- You may still sense the engine brake performance, even when you release the accelerator pedal in SMART SPORT mode. It is because your vehicle remains to be in a lower gear over a certain period of time for next acceleration. Thus, it is a normal driving situation, not indicating any malfunction.
- The driving mode automatically changes to SMART SPORT mode only in harsh driving situations. In most of the normal driving situations, the driving mode sets to be either in SMART ECO mode.

Limitation of SMART mode

The SMART mode may be limited in following situations. (The OFF indicator illuminates in those situations.)

- Smart Cruise Control is activated :
Smart Cruise Control may deactivate SMART mode when the vehicle is controlled by the set speed of Smart Cruise Control. (SMART mode is not deactivated just by turning on Smart Cruise Control)
- The transmission oil temperature is either extremely low or extremely high :
The SMART mode can be active in most of the normal driving situations. However, an extremely high/ low transmission oil temperature may temporarily deactivate the SMART mode, because the transmission condition is out of normal operation condition.

DRIVE MODE INTEGRATED CONTROL SYSTEM (4WD) (IF EQUIPPED)

Drive mode

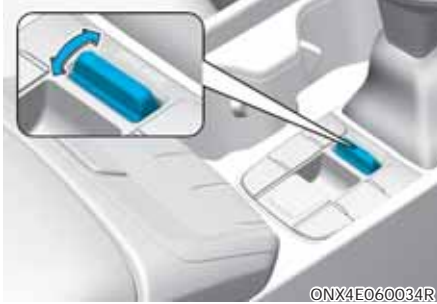

Drive mode may be selected according to the driver's preference or road condition.

NORMAL mode

NORMAL mode provides smooth driving and comfortable riding.

ECO mode



ECO mode helps improve fuel efficiency for eco-friendly driving.

Fuel efficiency varies according to the driver's driving habit and road condition.

- When ECO mode is selected, the ECO indicator will illuminate on the instrument cluster.
- When ECO mode is activated:
 - The acceleration response may be slightly reduced if the accelerator pedal is depressed moderately.
 - The air conditioner performance may be limited.
 - The shift pattern of the automatic transmission may change.
 - Engine noise may be louder at some automatic transmission shifts as down-shift requires pressing down more on the accelerator.

The above situations are normal conditions when ECO mode is activated to help improve fuel efficiency.

Limitations of ECO mode

If the following conditions occur while ECO mode is operating, the system operation is limited even though there is no change in the ECO indicator.

- When coolant temperature is low:
The system will be limited until engine performance becomes normal.
- When driving up a hill:
The system will be limited to gain power when driving uphill because engine torque is restricted.

The system will be limited according to the shift location.

SPORT mode



SPORT mode provides sporty but firm riding.

In SPORT mode, the fuel efficiency may decrease.

- When SPORT mode is selected, the SPORT indicator will illuminate on the instrument cluster.
- Whenever the engine is restarted, the drive mode will revert back to COMFORT mode. If SPORT mode is desired, re-select SPORT mode.
- When SPORT mode is activated:
 - The engine rpm will tend to remain raised over a certain length of time even after releasing the accelerator
 - Upshifts are delayed when accelerating

SMART mode

SMART SMART mode selects the proper driving mode among ECO, COMFORT and SPORT by judging the driver's driving habits (i.e. mild or dynamic) from the brake pedal depression or the steering wheel operation.

- Press the DRIVE MODE button to activate SMART mode. When SMART mode is activated, the indicator illuminates on the instrument cluster.
- The vehicle starts in SMART mode, when the engine was turned OFF in SMART mode.
- SMART mode automatically controls gear shifting patterns, engine torque, in accordance with the driver's driving habits.

i Information

- **When you mildly drive the vehicle in SMART mode, the driving mode changes to ECO mode to improve fuel efficiency. However, the actual fuel efficiency may differ in accordance with your driving situations (for example, upward/downward slope, vehicle deceleration/acceleration).**
- **When you dynamically drive the vehicle in SMART mode by abruptly decelerating or sharply curving, the driving mode changes to SPORT mode. However, it may adversely affect fuel economy.**

Various driving situations, which you may encounter in SMART mode

- The driving mode automatically changes to ECO mode after a certain period of time, when you gently depress the accelerator pedal (Your driving is categorized to be mild.).
- The driving mode automatically changes from SMART ECO mode to SMART SPORT mode after a certain period of time, when you sharply or repetitively depress the accelerator pedal.
- The driving mode automatically changes to SMART SPORT mode with the same driving patterns, when the vehicle starts to drive on an upward slope of a certain angle. The driving mode automatically returns to SMART ECO mode, when the vehicle enters a leveled road.
- The driving mode automatically changes to SMART SPORT, when you abruptly accelerate the vehicle or repetitively operate the steering wheel (Your driving is categorized to be sporty.). In this mode, your vehicle drives in a lower gear for abrupt accelerating/decelerating and increases the engine brake performance.
- You may still sense the engine brake performance, even when you release the accelerator pedal in SMART SPORT mode. It is because your vehicle remains to be in a lower gear over a certain period of time for next acceleration. Thus, it is a normal driving situation, not indicating any malfunction.
- The driving mode automatically changes to SMART SPORT mode only in harsh driving situations. In most of the normal driving situations, the driving mode sets to be either in SMART ECO mode.

Limitation of SMART mode

The SMART mode may be limited in following situations. (The OFF indicator illuminates in those situations.)

- Smart Cruise Control is activated : Smart Cruise Control may deactivate SMART mode when the vehicle is controlled by the set speed of Smart Cruise Control. (SMART mode is not deactivated just by turning on Smart Cruise Control)
- The transmission oil temperature is either extremely low or extremely high : The SMART mode can be active in most of the normal driving situations. However, an extremely high/ low transmission oil temperature may temporarily deactivate the SMART mode, because the transmission condition is out of normal operation condition.

Multi terrain mode



Multi terrain mode may be selected according to the driver's preference or road condition.

Press the DRIVE/TERRAIN button to change from Drive mode to Multi terrain mode. After the button is pressed, rotate the knob within 4 seconds to select SNOW, MUD or SAND. When the DRIVE/TERRAIN button is pressed again, the previous Drive mode will be reselected.

For more details on Terrain mode, refer to "Four wheel drive" section in this chapter.

SPECIAL DRIVING CONDITIONS

Hazardous driving conditions

When hazardous driving elements are encountered such as water, snow, ice, mud and sand, take the following precautions:

- Drive cautiously and maintain a longer braking distance.
- Avoid abrupt braking or steering.
- When your vehicle is stuck in snow, mud, or sand, use second gear. Accelerate slowly to avoid unnecessary wheel spin.
- Put sand, rock salt, tire chains or other non-slip materials under the wheels to provide additional traction while the vehicle becomes stuck in ice, snow, or mud.



WARNING

Downshifting with an automatic transmission while driving on slippery surfaces can cause an accident. The sudden change in tire speed could cause the tires to skid. Be careful when downshifting on slippery surfaces.

Rocking the vehicle

If it is necessary to rock the vehicle to free it from snow, sand, or mud, first turn the steering wheel right and left to clear the area around your front wheels. Then, shift back and forth between R (Reverse) and a forward gear.

Try to avoid spinning the wheels, and do not race the engine.

To prevent transmission wear, wait until the wheels stop spinning before shifting gears. Release the accelerator pedal while shifting, and press lightly on the accelerator pedal while the transmission is in gear. Slowly spinning the wheels in forward and reverse directions causes a rocking motion that may free the vehicle.



WARNING

If the vehicle is stuck and excessive wheel spin occurs, the temperature in the tires can increase very quickly. If the tires become damaged, a tire blow out or tire explosion can occur. This condition is dangerous - you and others may be injured. Do not attempt this procedure if people or objects are anywhere near the vehicle.

If you attempt to free the vehicle, the vehicle can overheat quickly, possibly causing an engine compartment fire or other damage. Try to avoid spinning the wheels as much as possible to prevent overheating of either the tires or the engine. **DO NOT** allow the vehicle to spin the wheels above 56 km/h (35 mph).



Information

The ESC system must be turned OFF before rocking the vehicle.

NOTICE

If you are still stuck after rocking the vehicle a few times, have the vehicle pulled out by a tow vehicle to avoid engine overheating, possible damage to the transmission, and tire damage. See “Towing” section in chapter 8.

Smooth cornering

Avoid braking or gear changing in corners, especially when roads are wet. Ideally, corners should always be taken under gentle acceleration.

Driving at night

Night driving presents more hazards than driving in the daylight. Here are some important tips to remember:

- Slow down and keep more distance between you and other vehicles, as it may be more difficult to see at night, especially in areas where there may not be any street lights.
- Adjust your mirrors to reduce the glare from other drivers' headlamps.
- Keep your headlamps clean and properly aimed. Dirty or improperly aimed headlamps will make it much more difficult to see at night.
- Avoid staring directly at the headlamps of oncoming vehicles. You could be temporarily blinded, and it will take several seconds for your eyes to readjust to the darkness.

Driving in the rain

Rain and wet roads can make driving dangerous. Here are a few things to consider when driving in the rain or on slick pavement:

- Slow down and allow extra following distance. A heavy rainfall makes it harder to see and increases the distance needed to stop your vehicle.
- Turn OFF your Cruise Control.
- Replace your windshield wiper blades when they show signs of streaking or missing areas on the windshield.
- Be sure your tires have enough tread. If your tires do not have enough tread, making a quick stop on wet pavement can cause a skid and possibly lead to an accident. See “Tire Tread” section in chapter 9.
- Turn on your headlamps to make it easier for others to see you.
- Driving too fast through large puddles can affect your brakes. If you must go through puddles, try to drive through them slowly.
- If you believe your brakes may be wet, apply them lightly while driving until normal braking operation returns.

Hydroplaning

If the road is wet enough and you are going fast enough, your vehicle may have little or no contact with the road surface and actually ride on the water. The best advice is SLOW DOWN when the road is wet.

The risk of hydroplaning increases as the depth of tire tread decreases, refer to “Tire Tread” section in chapter 9.

Driving in flooded areas

Avoid driving through flooded areas unless you are sure the water is no higher than the bottom of the wheel hub. Drive through any water slowly. Allow adequate stopping distance because brake performance may be reduced.

After driving through water, dry the brakes by gently applying them several times while the vehicle is moving slowly.

Highway driving

Tires

Adjust the tire inflation, as specified. Under-inflation may overheat or damage the tires.

Do not install worn-out or damaged tires, which may reduce traction or fail the braking operation.

Information

Never over-inflate your tires above the maximum inflation pressure, as specified on your tires.

Fuel, engine coolant and engine oil

Driving at higher speeds on the highway consumes more fuel and is less efficient than driving at a slower, more moderate speed. Maintain a moderate speed in order to conserve fuel when driving on the highway.

Be sure to check both the engine coolant level and the engine oil before driving.

Drive belt

A loose or damaged drive belt may overheat the engine.

Reducing the risk of a rollover

Your multi-purpose passenger vehicle is defined as a Sports Utility Vehicle (SUV). SUV's have higher ground clearance and a narrower track to make them capable of performing in a wide variety of off-road applications. The specific design characteristics give them a higher center of gravity than ordinary vehicles making them more likely to roll over if you make abrupt turns. Utility vehicles have a significantly higher rollover rate than other types of vehicles. Due to this risk, driver and passengers are strongly recommended to buckle their seat belts. In a rollover crash, an unbelted person is significantly more likely to die than a person wearing a seat belt.

There are steps that a driver can make to reduce the risk of a rollover. If at all possible, avoid sharp turns or abrupt maneuvers, do not load your vehicle with heavy cargo on the roof, and never modify your vehicle in any way.

WARNING

Utility vehicles have a significantly higher rollover rate than other types of vehicles. To prevent rollovers or loss of control:

- Take corners at slower speeds than you would with a passenger vehicle.
- Avoid sharp turns and abrupt maneuvers.
- Do not modify your vehicle in any way that you would raise the center of gravity.
- Keep tires properly inflated.
- Do not carry heavy cargo on the roof.

WARNING

In a rollover crash, an unbelted person is significantly more likely to die than a person wearing a seat belt. Make sure all passengers are wearing their seat belts.

WINTER DRIVING

The severe weather conditions of winter quickly wear out tires and cause other problems. To minimize winter driving problems, you should take the following suggestions:

Information

Information for Snow Tires and Tire Chains in the national language(Icelandic) is provided in the Appendix.

Snow or icy conditions

You need to keep sufficient distance between your vehicle and the vehicle in front of you.

Apply the brakes gently. Speeding, rapid acceleration, sudden brake applications, and sharp turns are potentially very hazardous practices. During deceleration, use engine braking to the fullest extent. Sudden brake applications on snowy or icy roads may cause the vehicle to skid.

To drive your vehicle in deep snow, it may be necessary to use snow tires or to install tire chains on your tires.

Always carry emergency equipment. Some of the items you may want to carry include tire chains, tow straps or chains, a flashlight, emergency flares, sand, a shovel, jumper cables, a window scraper, gloves, ground cloth, coveralls, a blanket, etc.

Snow tires



WARNING

Snow tires should be equivalent in size and type to the vehicle's standard tires. Otherwise, the safety and handling of your vehicle may be adversely affected.

We recommend that you use snow tires when road temperature is below 7°C (45°F). Refer to the below chart, and mount the recommended snow tire for your vehicle.

If you mount snow tires on your vehicle, make sure to use the same Inflation pressure as the original tires. Mount snow tires on all four wheels to balance your vehicle's handling in all weather conditions. The traction provided by snow tires on dry roads may not be as high as your vehicle's original equipment tires. Check with the tire dealer for maximum speed recommendations.

Tire chains



Since the sidewalls of radial tires are thinner than other types of tires, they may be damaged by mounting some types of tire chains on them. Therefore, the use of snow tires is recommended instead of tire chains. If tire chains must be used, use genuine HYUNDAI Parts or the equivalent specified for your vehicle and install the tire chain after reviewing the instructions provided with the tire chains. Damage to your vehicle caused by improper tire chain use is not covered by your vehicle manufacturer's warranty.

When using tire chains, attach them to the drive wheels as follows.

2WD : Front wheels

4WD : All four wheels

If a full set of chains is not available for an 4WD vehicle, chains may be installed on the front wheels only.

WARNING

The use of tire chains may adversely affect vehicle handling:

- Drive less than 30 km/h (20 mph) or the chain manufacturer's recommended speed limit, whichever is lower.
- Drive carefully and avoid bumps, holes, sharp turns, and other road hazards, which may cause the vehicle to bounce.
- Avoid sharp turns or locked wheel braking.

Information

- **Install tire chains only in pairs and on the front tires. It should be noted that installing tire chains on the tires will provide a greater driving force, but will not prevent side skids.**
- **Do not install studded tires without first checking local and municipal regulations for possible restrictions against their use.**

Chain Installation

When installing tire chains, follow the manufacturer's instructions and mount them as tightly possible. Drive slowly (less than 30 km/h (20 mph)) with chains installed. If you hear the chains contacting the body or chassis, stop and tighten them. If they still make contact, slow down until the noise stops. Remove the tire chains as soon as you begin driving on cleared roads.

When mounting snow chains, park the vehicle on level ground away from traffic. Turn on the vehicle Hazard Warning Flasher and place a triangular emergency warning device behind the vehicle (if available). Always place the vehicle in P (Park), apply the parking brake and turn off the engine before installing snow chains.

NOTICE

When using tire chains:

- Wrong size chains or improperly installed chains can damage your vehicle's brake lines, suspension, body and wheels.
- If you hear noise caused by chains contacting the body, retighten the chain to prevent contact with the vehicle body.
- To prevent body damage, retighten the chains after driving 0.5~1.0 km (0.3~0.6 miles).
- Do not use tire chains on vehicles equipped with aluminum wheels. If unavoidable, use a wire type chain.
- Use wire chains less than 12 mm (0.47 in.) thick to prevent damage to the chain's connection.

Winter precautions

Use high quality ethylene glycol coolant

Your vehicle is delivered with high quality ethylene glycol coolant in the cooling system. It is the only type of coolant that should be used because it helps prevent corrosion in the cooling system, lubricates the water pump and prevents freezing. Be sure to replace or replenish your coolant in accordance with the maintenance schedule in chapter 9. Before winter, have your coolant tested to assure that its freezing point is sufficient for the temperatures anticipated during the winter.

Check battery and cables

Winter temperatures affect battery performance. **Inspect the battery and cables, as specified in chapter 9.** We recommend the battery charging cables be checked by contact an authorized HYUNDAI or in a service station.

Change to “winter weight” oil if necessary

In some regions during winter, it is recommended to use the “winter weight” oil with lower viscosity. In addition, replace the engine oil and filter if it is close to the next maintenance interval. Fresh engine oil ensures optimum engine operation during the winter months. For further information, refer to chapter 2. When you are not sure about a type of winter weight oil, we recommend that you consult an authorized HYUNDAI dealer.

Check spark plugs and ignition system

Inspect the spark plugs, as specified in chapter 8. If necessary, replace them. Also check all ignition wirings and components for any cracks, wear-out, and damage.

To prevent locks from freezing

To prevent the locks from being frozen, spray approved de-icing fluid or glycerin into key holes. When a lock opening is already covered with ice, spray approved de-icing fluid over the ice to remove it. When an internal part of a lock freezes, try to thaw it with a heated key. Carefully use the heated key to avoid an injury.

Use approved window washer anti-freeze solution in system

To prevent the window washer from being frozen, add authorized window washer anti-freeze solution, as specified on the window washer container.

Window washer anti-freeze solution is available from an authorized HYUNDAI dealer, and most vehicle accessory outlets. Do not use engine coolant or other types of anti-freeze solution, to prevent any damage to the vehicle paint.

Do not let your parking brake freeze

Under some conditions your parking brake can freeze in the engaged position. This is most likely to happen when there is an accumulation of snow or ice around or near the rear brakes or if the brakes are wet. When there is the risk that your parking brake may freeze, temporarily apply it with the gear in P (Park). Also, block the rear wheels in advance, so the vehicle may not roll. Then, release the parking brake.

Do not let ice and snow accumulate underneath

Under some conditions, snow and ice can build up under the fenders and interfere with the steering. When driving in such conditions during the severe winter, you should check underneath the vehicle on a regular basis, to ensure that the front wheels and the steering components is unblocked.

Carry emergency equipment

In accordance with weather conditions, you should carry appropriate emergency equipment, while driving. Some of the items you may want to carry include tire chains, tow straps or chains, flashlight, emergency flares, sand, shovel, jumper cables, window scraper, gloves, ground cloth, coveralls, blanket, etc.

Do not place objects or materials in the engine compartment

Putting objects or materials in the engine compartment may cause an engine failure or combustion, because they may block the engine cooling. Such damage will not be covered by the manufacturer's warranty.

Drive your vehicle when water vapor condenses and accumulates inside the exhaust pipes

When the vehicle is stopped for a long time in winter while the engine is running, water vapor may condense and accumulate inside the exhaust pipes. Water in the exhaust pipes may cause noise, etc., but it is drained driving at medium to high speed.

TRAILER TOWING

If you are considering to tow with your vehicle, you should first check your country's legal requirements. As laws vary the requirements for towing trailers, cars, or other types of vehicles or apparatus may differ. When you are not sure about a type of winter weight oil, we recommend that you consult an authorized HYUNDAI dealer.

Remember that trailering is different than just driving your vehicle by itself. Trailering means changes in handling, durability, and fuel economy. Successful, safe trailering requires correct equipment, and it has to be used properly. Damage to your vehicle caused by improper trailer towing is not covered by your vehicle manufacturer's warranty.

This section contains many time-tested, important trailering tips and safety rules. Many of these are important for your safety and that of your passengers. Please read this section carefully before you pull a trailer.



WARNING

Take the following precautions:

- If you don't use the correct equipment and/or drive improperly, you can lose control of the vehicle when you are pulling a trailer. For example, if the trailer is too heavy, the braking performance may be reduced. You and your passengers could be seriously or fatally injured. Pull a trailer only if you have followed all the steps in this section.
- Before towing, make sure the total trailer weight, GCW (Gross Combination Weight), GVW (Gross Vehicle Weight), GAW (Gross Axle Weight) and trailer tongue load are all within the limits.
- When you tow a trailer, make sure to turn off the Idle Stop and Go system.



Information

- **The technically permissible maximum load on the rear axle(s) may be exceeded by not more than 15 % and the technically permissible maximum laden mass of the vehicle may be exceeded by not more than 10% or 100 kg (220.4 lbs), whichever value is lower. In this case, do not exceed 100 km/h (62.1 mph) for vehicle of category M1 or 80 km/h (49.7 mph) for vehicle of category N1.**
- **When a vehicle of category M1 is towing a trailer, the additional load imposed at the trailer coupling device may cause the tire maximum load ratings to be exceeded, but not by more than 15%. In this case, do not exceed 100 km/h (62.1 mph) and increase the tire inflation pressure by at least 0.2 bar.**
- * M1 : passenger vehicle (9-seater or under)
- * N1 : commercial vehicle (3.5 ton or under)

If you decide to pull a trailer?

Here are some important points if you decide to pull a trailer:

- Consider using a sway control. You can ask a trailer hitch dealer about sway control.
- Do not do any towing with your vehicle during its first 2,000 km (1,200 miles) in order to allow the engine to properly break in. Failure to heed this caution may result in serious engine or transmission damage.
- When towing a trailer, we recommend that you consult an authorized HYUNDAI dealer for further information on additional requirements such as a towing kit, etc.
- Always drive your vehicle at a moderate speed (less than 100 km/h (60 mph)) or posted towing speed limit.
- On a long uphill grade, do not exceed 70 km/h (45 mph) or the posted towing speed limit, whichever is lower.
- Carefully observe the weight and load limits provided in the following pages.

Trailer weight

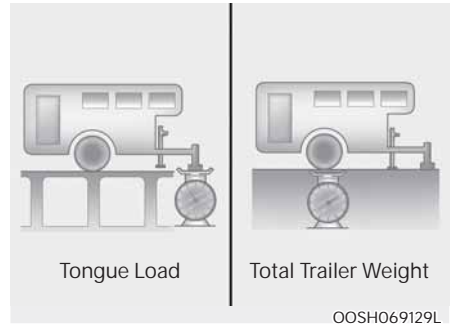

What is the maximum safe weight of a trailer? It should never weigh more than the maximum trailer weight with trailer brakes. But even that can be too heavy. It depends on how you plan to use your trailer. For example, speed, altitude, road grades, outside temperature and how often your vehicle is used to pull a trailer are all important. The ideal trailer weight can also depend on any special equipment that you have on your vehicle.

Tongue load

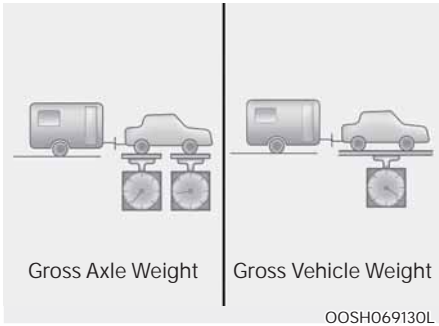

The tongue load is an important weight to measure because it affects the total Gross Vehicle Weight (GVW) of your vehicle. The trailer tongue should weigh a maximum of 10% of the total loaded trailer weight, within the limits of the maximum trailer tongue load permissible.

After you've loaded your trailer, weigh the trailer and then the tongue, separately, to see if the weights are proper. If they aren't, you may be able to correct them simply by moving some items around in the trailer.

WARNING

Take the following precautions:

- Never load a trailer with more weight in the rear than in the front. The front should be loaded with approximately 60% of the total trailer load; the rear should be loaded with approximately 40% of the total trailer load.
- Never exceed the maximum weight limits of the trailer or trailer towing equipment. Improper loading can result in damage to your vehicle and/or personal injury. Check weights and loading at a commercial scale or highway patrol office equipped with scales.

Information

With increasing altitude the engine performance decreases. From 1,000 m above sea level and for every 1,000 m thereafter 10% of vehicle/trailer weight (trailer weight + gross vehicle weight) must be deducted.

Reference weight and distance when towing a trailer

Item		Smartstream G2.0	Smartstream D2.0
		A/T	A/T
Maximum trailer weight kg (lbs.)	Without brake system	750 (1,653)	
	With brake system	1,650 (3,638)	1,900 (4,189)
Maximum permissible static vertical load on the coupling device kg (lbs.)		100 (220)	
Recommended distance from rear wheel center to coupling point mm (inch)		1,025 (43)	

Trailer towing equipment

Hitches

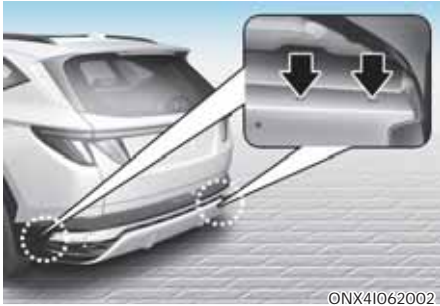

i Information

The mounting hole for hitches are located on both sides of the underbody behind the rear tires.

It's important to have the correct hitch equipment. Crosswinds, large trucks going by, and rough roads are a few reasons why you'll need the right hitch. Here are some rules to follow:

- Do you have to make any holes in the body of your vehicle when you install a trailer hitch? If you do, then be sure to seal the holes later when you remove the hitch. If you don't seal them, carbon monoxide (CO) from your exhaust can get into your vehicle, as well as dirt and water.
- The bumpers on your vehicle are not intended for hitches. Do not attach rental hitches or other bumper-type hitches to them. Use only a frame-mounted hitch that does not attach to the bumper.

- Any part of the rear number plate or lighting devices of the vehicle must not be obscured by the mechanical coupling device.

If the rear number plate and/or lighting devices can be obscured partially by any part of the mechanical coupling device, mechanical coupling devices that can not be easily removed or repositioned without use of any tools, except an easily operated (for example, an effort not exceeding 20Nm) release key which is supplied by the manufacturer of the coupling device, are not permitted for use.

Please note that the mechanical coupling device that is fitted and not in use must always be removed or repositioned if the rear number plate and/or rear lighting devices are obscured by any part of the mechanical coupling device.

- A HYUNDAI trailer hitch accessory is available at an authorized HYUNDAI dealer.

Safety chains

You should always attach chains between your vehicle and your trailer.

Instructions about safety chains may be provided by the hitch manufacturer or trailer manufacturer. Follow the manufacturer's recommendation for attaching safety chains. Always leave just enough slack so you can turn with your trailer. And, never allow safety chains to drag on the ground.

Trailer brakes

If your trailer is equipped with a braking system, make sure it conforms to your country's regulations and that it is properly installed and operating correctly.

If your trailer weighs more than the maximum trailer weight without trailer brakes loaded, then it needs its own brakes and they must be adequate. Be sure to read and follow the instructions for the trailer brakes so you'll be able to install, adjust and maintain them properly. Be sure not to modify your vehicle's brake system.



WARNING

Do not use a trailer with its own brakes unless you are absolutely certain that you have properly set up the brake system. This is not a task for amateurs. Use an experienced, competent trailer shop for this work.

Driving with a trailer

Towing a trailer requires a certain amount of experience. Before setting out for the open road, you must get to know your trailer. Acquaint yourself with the feel of handling and braking with the added weight of the trailer. And always keep in mind that the vehicle you are driving is now longer and not nearly as responsive as your vehicle is by itself.

Before you start, check the trailer hitch and platform, safety chains, electrical connector(s), lights, tires and brakes.

During your trip, occasionally check to be sure that the load is secure, and that the lights and trailer brakes are still working.

Distance

Stay at least twice as far behind the vehicle ahead as you would when driving your vehicle without a trailer. This can help you avoid situations that require heavy braking and sudden turns.

Passing

You will need more passing distance up ahead when you're towing a trailer. And, because of the increased vehicle length, you'll need to go much farther beyond the passed vehicle before you can return to your lane.

Backing up

Hold the bottom of the steering wheel with one hand. Then, to move the trailer to the left, move your hand to the left. To move the trailer to the right, move your hand to the right. Always back up slowly and, if possible, have someone guide you.

Making turns

When you're turning with a trailer, make wider turns than normal. Do this so your trailer won't strike soft shoulders, curbs, road signs, trees, or other objects. Avoid jerky or sudden maneuvers. Signal well in advance.

Turn signals

When you tow a trailer, your vehicle has to have a different turn signal flasher and extra wiring. The green arrows on your instrument panel will flash whenever you signal a turn or lane change. Properly connected, the trailer lights will also flash to alert other drivers you're about to turn, change lanes, or stop.

When towing a trailer, the green arrows on your instrument panel will flash for turns even if the bulbs on the trailer are burned out. Thus, you may think drivers behind you are seeing your signals when, in fact, they are not. It's important to check occasionally to be sure the trailer bulbs are still working. You must also check the lights every time you disconnect and then reconnect the wires.



WARNING

Do not connect a trailer lighting system directly to your vehicle's lighting system. Use an approved trailer wiring harness. Failure to do so could result in damage to the vehicle electrical system and/or personal injury. We recommend that you consult an authorized HYUNDAI dealer for assistance.

Driving on hills

Reduce speed and shift to a lower gear before you start down a long or steep downgrade. If you don't shift down, you might have to use your brakes so much that they would get overheated and may not operate efficiently.

On a long uphill grade, shift down and reduce your speed to around 70 km/h (45 mph) to reduce the possibility of engine and transmission overheating.

If your trailer weighs more than the maximum trailer weight without trailer brakes and you have an automatic transmission, you should drive in D (Drive) when towing a trailer.

Operating your vehicle in D (Drive) when towing a trailer will minimize heat build-up and extend the life of your transmission.

NOTICE

To prevent engine and/or transmission overheating:

- When towing a trailer on steep grades (in excess of 6%) pay close attention to the engine coolant temperature gauge to ensure the engine does not overheat. If the needle of the coolant temperature gauge moves towards "H" (HOT), pull over and stop as soon as it is safe to do so, and allow the engine to idle until it cools down. You may proceed once the engine has cooled sufficiently.
- If you tow a trailer with the maximum gross vehicle weight and maximum trailer weight, it can cause the engine or transmission to overheat. When driving in such conditions, allow the engine to idle until it cools down. You may proceed once the engine or transmission has cooled sufficiently.
- When towing a trailer, your vehicle speed may be much slower than the general flow of traffic, especially when climbing an uphill grade. Use the right hand lane when towing a trailer on an uphill grade. Choose your vehicle speed according to the maximum posted speed limit for vehicles with trailers, the steepness of the grade, and your trailer weight.

Parking on hills

Generally, if you have a trailer attached to your vehicle, you should not park your vehicle on a hill.

However, if you ever have to park your trailer on a hill, here's how to do it:

1. Pull the vehicle into the parking space. Turn the steering wheel in the direction of the curb (right if headed down hill, left if headed up hill).
2. Shift the gear to P (Park).
3. Set the parking brake and shut off the vehicle.
4. Place wheel chocks under the trailer wheels on the down hill side of the wheels.
5. Start the vehicle, hold the brakes, shift to neutral, release the parking brake and slowly release the brakes until the trailer chocks absorb the load.
6. Reapply the brakes and parking brakes.
7. Shift the gear to P (Park) when the vehicle is parked on a uphill grade and in R (Reverse) on a downhill.
8. Shut off the vehicle and release the vehicle brakes but leave the parking brake set.

**WARNING**

To prevent serious or fatal injury:

- Do not get out of the vehicle without the parking brake firmly set. If you have left the engine running, the vehicle can move suddenly. You and others could be seriously or fatally injured.
- Do not apply the accelerator pedal to hold the vehicle on an uphill.

Driving the vehicle after it has been parked on a hill

1. With the gear in P (Park), apply your brakes and hold the brake pedal down while you:
 - Start your engine;
 - Shift into gear; and
 - Release the parking brake.
2. Slowly remove your foot from the brake pedal.
3. Drive slowly until the trailer is clear of the chocks.
4. Stop and have someone pick up and store the chocks.

Maintenance when towing a trailer

Your vehicle will need service more often when you regularly pull a trailer. Important items to pay particular attention to include engine oil, transmission fluid, axle lubricant and cooling system fluid. Brake condition is another important item to frequently check. If you're trailering, it's a good idea to review these items before you start your trip. Don't forget to also maintain your trailer and hitch. Follow the maintenance schedule that accompanied your trailer and check it periodically. Preferably, conduct the check at the start of each day's driving. Most importantly, all hitch nuts and bolts should be tight.

NOTICE

To prevent vehicle damage:

- Due to higher load during trailer usage, overheating might occur on hot days or during uphill driving. If the coolant gauge indicates over-heating, switch off the air conditioner and stop the vehicle in a safe area to cool down the engine.
- Do not switch off the engine while the coolant gauge indicates over-heating.
(Keep the engine idle to cool down the engine)
- When towing check transmission fluid more frequently.
- If your vehicle is not equipped with an air conditioner, you should install a condenser fan to improve engine performance when towing a trailer.

VEHICLE WEIGHT

Two labels on your driver's door sill show how much weight your vehicle was designed to carry: the Tire and Loading Information Label and the Certification Label.

Before loading your vehicle, familiarize yourself with the following terms for determining your vehicle's weight ratings, from the vehicle's specifications and the Certification Label:

Base Curb Weight

This is the weight of the vehicle including a full tank of fuel and all standard equipment. It does not include passengers, cargo, or optional equipment.

Vehicle Curb Weight

This is the weight of your new vehicle when you picked it up from your dealer plus any aftermarket equipment.

Cargo Weight

This figure includes all weight added to the Base Curb Weight, including cargo and optional equipment.

GAW (Gross Axle Weight)

This is the total weight placed on each axle (front and rear) - including vehicle curb weight and all payload.

GAWR (Gross Axle Weight Rating)

This is the maximum allowable weight that can be carried by a single axle (front or rear). These numbers are shown on the Certification Label. The total load on each axle must never exceed its GAWR.

GVW (Gross Vehicle Weight)

This is the Base Curb Weight plus actual Cargo Weight plus passengers.

GVWR (Gross Vehicle Weight Rating)

This is the maximum allowable weight of the fully loaded vehicle (including all options, equipment, passengers and cargo). The GVWR is shown on the Certification Label located on the driver's door sill.

Overloading



WARNING

The Gross Axle Weight Rating (GAWR) and the Gross Vehicle Weight Rating (GVWR) for your vehicle are on the Certification Label attached to the driver's (or front passenger's) door. Exceeding these ratings can cause an accident or vehicle damage. You can calculate the weight of your load by weighing the items (and people) before putting them in the vehicle. Be careful not to overload your vehicle.

7. Driver Assistance System

The description of each feature of the driver assistance system may differ from the owner's manual depending on the infotainment software update. Refer to the web manual that you can access with the QR code in the infotainment system quick reference.

Driving Safety	
Forward Collision–Avoidance Assist (FCA) (Sensor fusion)	7-3
Lane Keeping Assist (LKA)	7-19
Blind-Spot Collision-Avoidance Assist (BCA)	7-25
Safe Exit Warning (SEW)	7-38
Manual Speed Limit Assist (MSLA)	7-43
Driver Attention Warning (DAW)	7-46
Blind-Spot View Monitor (BVM)	7-52
Driving Convenience	
Cruise Control (CC)	7-54
Smart Cruise Control (SCC)	7-58
Lane Following Assist (LFA)	7-74
Parking Safety	
Rear View Monitor (RVM)	7-78
Surround View Monitor (SVM)	7-82
Rear Cross-Traffic Collision-Avoidance Assist (RCCA)	7-88
Reverse Parking Distance Warning (PDW)	7-98
Forward/Reverse Parking Distance Warning (PDW)	7-102

DRIVER ASSISTANCE SYSTEM

NOTICE

- The Advance Driver Assistance System uses camera and radar system to give signals and controls to improve the safety surroundings and comfort of the driver. It should be noted that ADAS only assists the driver and it does not interchange or substitute with the driver.
- The ADAS delivers vast benefits to driver, but the driver shall be only accountable for driving the car. Driver must be attentive while driving and should follow the traffic rules and regulations.

FORWARD COLLISION-AVOIDANCE ASSIST (FCA) (SENSOR FUSION) (IF EQUIPPED)

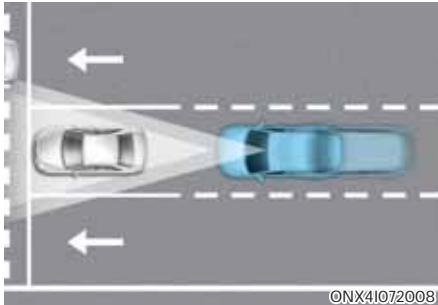

Forward Collision-Avoidance Assist is designed to help detect and monitor the vehicle ahead or help detect a pedestrian or cyclist in the roadway and warn the driver that a collision is imminent with a warning message, an audible warning and application of emergency braking.

Junction Turning function

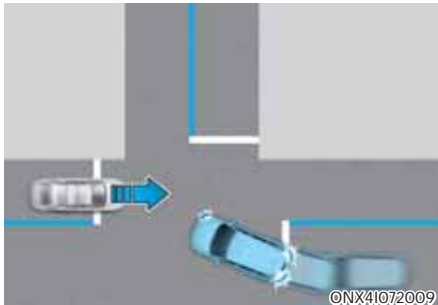

Junction Turning function can help avoid a collision with an oncoming vehicle in an adjacent lane when turning left or right at a crossroad with the turn signal on by applying emergency braking.

Detecting sensor



- [1] : Front view camera,
- [2] : Front radar

Refer to the picture above for the detailed location of the detecting sensors.



CAUTION

Take the following precautions to maintain optimal performance of the detecting sensor:

- Never disassemble the detecting sensor or sensor assembly, or cause any damage to it.
- If the detecting sensors have been replaced or repaired, we recommend that you have your vehicle inspected by an authorized HYUNDAI dealer.
- Never install any accessories or stickers on the front windshield, or tint the front windshield.
- Pay extreme caution to keep the front view camera dry.
- Never place any reflective objects (for example, white paper, mirror) over the dashboard.
- Do not place any objects near the front windshield or install any accessories on the front windshield. It can affect the performance of the defogging and defrosting function of the climate control system, which may prevent the Driver Assistance systems from operating.
- Do not apply license plate frame or objects, such as a bumper sticker, film or a bumper guard, near the front radar cover.
- Always keep the front radar and cover clean and free of dirt and debris.

Use only a soft cloth to wash the vehicle. Do not spray pressurized water directly on the sensor or sensor cover.

- If the radar or around the radar has been damaged or impacted in any way Forward Collision-Avoidance Assist may not properly operate even though a warning message does not appear on the cluster. We recommend that the vehicle be inspected by an authorized HYUNDAI dealer.
- Use only genuine parts or the equivalent specified for your vehicle to repair or replace a damaged front radar cover. Do not apply paint to the front radar cover.

Forward Collision-Avoidance Assist settings

Forward Safety

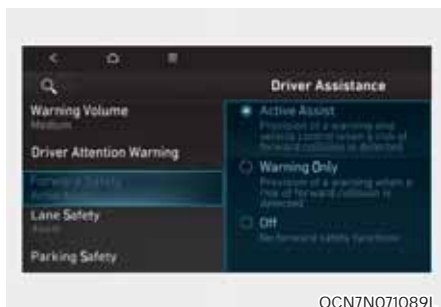

OCN7N071089L

With the engine on, select or deselect 'Driver Assistance → Forward Safety' from the Settings menu to set whether to use each function.

- If 'Active Assist' is selected, Forward Collision-Avoidance Assist will warn the driver with a warning message, an audible warning depending on the collision risk levels. Braking assist will be applied depending on the collision risk.
- If 'Warning Only' is selected, Forward Collision-Avoidance Assist will warn the driver with a warning message, an audible warning depending on the collision risk levels. Braking will not be assisted. The driver must apply the brake pedal or steer the vehicle if necessary.
- If 'Off' is selected, Forward Collision-Avoidance Assist will turn off. The  warning light will illuminate on the instrument cluster.

The driver can monitor Forward Collision-Avoidance Assist selected or deselected status from the Settings menu. If the  warning light remains On when Forward Collision-Avoidance Assist is On, we recommend that the vehicle be inspected by an authorized HYUNDAI dealer.

WARNING

When the engine is restarted, Forward Collision-Avoidance Assist will always turn on. However, if Forward Safety is deselected, the driver should always be aware of the surroundings and drive safely.

CAUTION

- If 'Warning Only' is selected, braking is not assisted.
- The settings for Forward Safety include 'Basic function' and 'Junction Turning'.

Information

Forward Collision-Avoidance Assist will turn off when ESC is turned off by pressing and holding the ESC Off button. The  warning light will illuminate on the cluster.

Warning Timing



With the engine on, select 'Driver Assistance → Driving Safety → Warning Timing' from the Settings menu to change the initial warning activation time for Forward Collision-Avoidance Assist.

When the vehicle is first delivered, Warning Timing is set to 'Normal'. If you change the Warning Timing, the Warning Timing of other Driver Assistance systems may change.

- Use 'Normal' in normal driving conditions. If the Warning Timing seems sensitive, change it to 'Late'.
- If 'Late' is selected, Blind-Spot Collision-Avoidance Assist, warns the driver more slowly.

Warning Volume



With the engine on, select 'Driver Assistance → Warning Volume' from the Settings menu to change the Warning Volume to 'High', 'Medium' or 'Low' for Forward Collision-Avoidance Assist.

If you change the Warning Volume, the Warning Volume of other Driver Assistance systems may change.

CAUTION

- The setting of the Warning Timing and Warning Volume applies to all functions of Forward Collision-Avoidance Assist.
- Even though 'Normal' is selected for Warning Timing, if the front vehicle suddenly stops, the warning may seem late.
- Select 'Late' for Warning Timing when traffic is light and when driving speed is slow.

Information

If the engine is restarted, Warning Timing and Warning Volume will maintain the last setting.

Forward Collision-Avoidance Assist operation

Basic function

Forward Collision-Avoidance Assist is to warn and help control the vehicle depending on the collision risk level: 'Collision Warning', 'Emergency Braking' and 'Stopping vehicle and ending brake control'.



Collision Warning

- To warn the driver of a collision, the 'Collision Warning' warning message will appear on the cluster, an audible warning will sound.
- If a vehicle is detected in front, the function will operate when your vehicle speed is between approximately 10-180 km/h (6-112 mph).
- If a pedestrian or cyclist is detected in front, the function will operate when your vehicle speed is between approximately 10-85 km/h (6-53 mph).
- If 'Active Assist' is selected, braking may be assisted.



Emergency Braking

- To warn the driver that emergency braking will be assisted, the 'Emergency Braking' warning message will appear on the cluster, an audible warning will sound.
- The function will operate under the following conditions, depending on the target and the degree of risk.
 - Target vehicle (weak braking):
Your vehicle speed is between approximately 10-180 km/h (6-112 mph)
 - Target vehicle (strong braking):
Your vehicle speed is between approximately 10-85 km/h (6-53 mph)
- If a pedestrian or cyclist is detected in front, the function will operate when your vehicle speed is between approximately 10-65 km/h (6-40 mph).
- In emergency braking situation, braking is assisted with strong braking power by the function to help prevent collision with the vehicle, pedestrian or cyclist ahead.



Stopping vehicle and ending brake control

- When the vehicle is stopped due to emergency braking, the 'Drive carefully' warning message will appear on the cluster.
For your safety, the driver should depress the brake pedal immediately and check the surroundings.
- Brake control will end after the vehicle is stopped by emergency braking for approximately 2 seconds.

Junction Turning function

Junction Turning function will warn and help control the vehicle depending on the collision risk level: 'Collision Warning', 'Emergency Braking' and 'Stopping vehicle and ending brake control'



Collision Warning

- To warn the driver of a collision, the 'Collision Warning' warning message will appear on the cluster, an audible warning will sound.
- The function will operate when your vehicle speed is between approximately 10-30 km/h (6-19 mph) and the oncoming vehicle speed is between approximately 30-70 km/h (19-44 mph).
- If 'Active Assist' is selected, braking may be assisted.



Emergency Braking

- To warn the driver that emergency braking will be assisted, the 'Emergency Braking' warning message will appear on the cluster, an audible warning will sound.
- The function will operate when your vehicle speed is between approximately 10-30 km/h (6-19 mph) and the oncoming vehicle speed is between approximately 30-70 km/h (19-44 mph).
- In emergency braking situations, braking is assisted with strong braking power by the function to help prevent collision with the oncoming vehicle.

Information

If the driver's seat is on the left side, Junction Turning function will operate only when you turn left. If the driver's seat position is on the right side, the function will operate only when you turn right.



Stopping vehicle and ending brake control

- When the vehicle is stopped due to emergency braking, the 'Drive carefully' warning message will appear on the cluster.
For your safety, the driver should depress the brake pedal immediately and check the surroundings.
- Brake control will end after the vehicle is stopped by emergency braking for approximately 2 seconds.



WARNING

Take the following precautions when using Forward Collision-Avoidance Assist:

- For your safety, only change the Settings after parking the vehicle at a safe location.
- With 'Active Assist' or 'Warning Only' selected, when ESC is turned off by pressing and holding the ESC OFF button, Forward Collision-Avoidance Assist will turn off automatically. In this case, Forward Collision-Avoidance Assist cannot be set from the Settings menu and the warning light will illuminate on the cluster which is normal. If ESC is turned on by pressing the ESC OFF button, Forward Collision-Avoidance Assist will maintain the last setting.
- Forward Collision-Avoidance Assist does not operate in all situations and cannot avoid all collisions.
- The driver has the responsibility to control the vehicle. Do not solely depend on Forward Collision-Avoidance Assist. Rather, maintain a safe braking distance, and if necessary, depress the brake pedal to reduce driving speed or to stop the vehicle.
- Never deliberately operate Forward Collision-Avoidance Assist on people, objects, etc. It may cause serious injury or death.
- Forward Collision-Avoidance Assist may not operate if the driver depresses the brake pedal to avoid a collision.

- Depending on the road and driving conditions, Forward Collision-Avoidance Assist may warn the driver late or may not warn the driver.
- During Forward Collision-Avoidance Assist operation, the vehicle may stop suddenly injuring passengers and shifting loose objects. Always have the seat belt on and keep loose objects secured.
- If any other function's warning message is displayed or audible warning is generated, Forward Collision-Avoidance Assist warning message may not be displayed and audible warning may not be generated.
- You may not hear the warning sound of Forward Collision-Avoidance Assist if the surrounding is noisy.
- Forward Collision-Avoidance Assist may turn off or may not operate properly or may operate unnecessarily depending on the road conditions and the surroundings.



WARNING

- Even if there is a problem with Forward Collision-Avoidance Assist, the vehicle's basic braking will function normally.
- During emergency braking, braking control by Forward Collision-Avoidance Assist will automatically cancel when the driver excessively depresses the accelerator pedal or sharply steers the vehicle.



CAUTION

- Depending on the condition of the vehicle, pedestrian and cyclist in front and the surroundings, the speed range to operate Forward Collision-Avoidance Assist may reduce. Forward Collision-Avoidance Assist may only warn the driver, or it may not operate.
- Forward Collision-Avoidance Assist will operate under certain conditions by judging the risk level based on the condition of the oncoming vehicle, driving direction, speed and surroundings.





Information

- In a situation where collision is imminent, braking may be assisted by Forward Collision-Avoidance Assist when braking is insufficient by the driver.**
- The images and colors in the instrument cluster may differ depending on the cluster type or theme selected from the instrument cluster.**

Forward Collision-Avoidance Assist malfunction and limitations

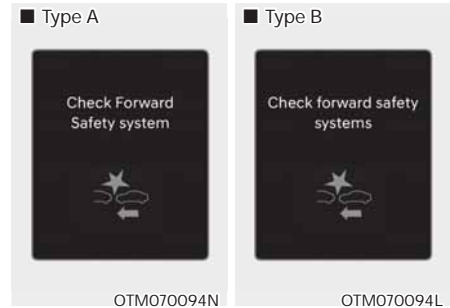
Forward Collision-Avoidance Assist malfunction





When Forward Collision-Avoidance Assist is not working properly, the 'Check Forward Safety system' (or 'Check forward safety systems') warning message will appear, and the  and  warning lights will illuminate on the cluster. We recommend that the vehicle be inspected by an authorized HYUNDAI dealer.

Forward Collision-Avoidance Assist disabled



When the front windshield where the front view camera is located, front radar cover or sensor is covered with foreign material, such as snow or rain, it can reduce the detecting performance and temporarily limit or disable Forward Collision-Avoidance Assist.

If this occurs the 'Forward Safety system(s)' disabled. Camera obscured' or the 'Forward Safety system' disabled. Radar blocked' warning message, and the  and  warning lights will illuminate on the cluster.

Forward Collision-Avoidance Assist will operate properly when such snow, rain or foreign material is removed.

If Forward Collision-Avoidance Assist does not operate properly after obstruction (snow, rain, or foreign material) is removed, we recommend that the vehicle be inspected by an authorized HYUNDAI dealer.

WARNING

- Even though the warning message or warning light does not appear on the cluster, Forward Collision-Avoidance Assist may not properly operate.
- Forward Collision-Avoidance Assist may not properly operate in an area (for example, open terrain), where any objects are not detected after turning ON the vehicle.

Limitations of the Forward Collision-Avoidance Assist

Forward Collision-Avoidance Assist may not operate properly, or it may operate unexpectedly under the following circumstances:

- The detecting sensor or the surroundings are contaminated or damaged
- The temperature around the front view camera is high or low due to surrounding environment
- The camera lens is contaminated due to tinted, filmed or coated windshield, damaged glass, or sticky foreign material (sticker, bug, etc.) on the glass
- Moisture is not removed or frozen on the windshield
- Washer fluid is continuously sprayed, or the wiper is on
- Driving in heavy rain or snow, or thick fog
- The field of view of the front view camera is obstructed by sun glare
- Street light or light from an oncoming traffic is reflected on the wet road surface, such as a puddle on the road
- An object is placed on the dashboard

- Your vehicle is being towed
- The surrounding is very bright
- The surrounding is very dark, such as in a tunnel, etc.
- The brightness changes suddenly, for example when entering or exiting a tunnel
- The brightness outside is low, and the headlamps are not on or are not bright
- Driving through steam, smoke or shadow
- Only part of the vehicle, pedestrian or cyclist is detected
- The vehicle in front is a bus, heavy truck, truck with an unusually shaped cargo, trailer, etc.
- The vehicle in front has no tail lights, tail lights are located unusually, etc.
- The brightness outside is low, and the tail lamps are not on or are not bright
- The rear of the front vehicle is small or the vehicle does not look normal, such as when the vehicle is tilted, overturned, or the side of the vehicle is visible, etc.
- The front vehicle's ground clearance is low or high
- A vehicle, pedestrian or cyclist suddenly cuts in front
- The bumper around the front radar is impacted, damaged or the front radar is out of position
- The temperature around the front radar is high or low
- Driving through a tunnel or iron bridge
- Driving in vast areas where there are few vehicles or structures (for example, desert, meadow, suburb, etc.)
- Driving near areas containing metal substances, such as a construction zone, railroad, etc.
- A material is near that reflects very well on the front radar, such as a guardrail, nearby vehicle, etc.
- The cyclist in front is on a bicycle made of material that does not reflect on the front radar
- The vehicle in front is detected late
- The vehicle in front is suddenly blocked by an obstacle
- The vehicle in front suddenly changes lane or suddenly reduces speed
- The vehicle in front is bent out of shape
- The front vehicle's speed is fast or slow
- The vehicle in front steers in the opposite direction of your vehicle to avoid a collision
- With a vehicle in front, your vehicle changes lane at low speed
- The vehicle in front is covered with snow
- You are departing or returning to the lane
- Unstable driving
- You are on a roundabout and the vehicle in front is not detected
- You are continuously driving in a circle
- The vehicle in front has an unusual shape
- The vehicle in front is driving uphill or downhill
- The pedestrian or cyclist is not fully detected, for example, if the pedestrian is leaning over or is not fully walking upright
- The pedestrian or cyclist is wearing clothing or equipment that makes it difficult to detect



The illustration above shows the image the front view camera and front radar are capable of detecting as a vehicle, pedestrian and cyclist.

- The pedestrian or cyclist in front is moving very quickly
- The pedestrian or cyclist in front is short or is posing a low posture
- The pedestrian or cyclist in front has impaired mobility
- Front view camera and front radar are capable of detecting is moving intersected with the driving direction
- There is a group of pedestrians, cyclists or a large crowd in front
- The pedestrian or cyclist is wearing clothing that easily blends into the background, making it difficult to detect
- The pedestrian or cyclist is difficult to distinguish from the similarly shaped structure in the surroundings
- You are driving by a pedestrian, cyclist, traffic sign, structure, etc., near the intersection
- Driving in a parking lot
- Driving through a tollgate, construction area, unpaved road, partial paved road, uneven road, speed bumps, etc.
- Driving on an incline road, curved road, etc.
- Driving through a roadside with trees or streetlights
- The adverse road conditions cause excessive vehicle vibrations while driving
- Your vehicle height is low or high due to heavy loads, abnormal tire pressure, etc.
- Driving through a narrow road where trees or grass are overgrown
- There is interference by electromagnetic waves, such as driving in an area with strong radio waves or electrical noise



WARNING

- Driving on a curved road

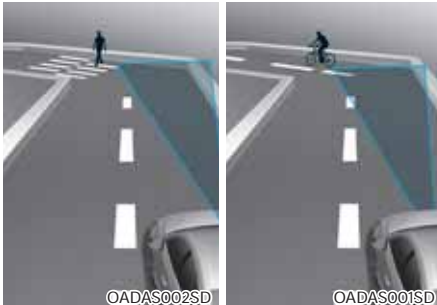

Forward Collision-Avoidance Assist may not detect other vehicles, pedestrians or cyclists in front of you on curved roads adversely affecting the performance of the sensors. This may result in no warning or braking assist when necessary.

When driving on a curved road, you must maintain a safe braking distance, and if necessary, steer the vehicle and depress the brake pedal to reduce your driving speed in order to maintain a safe distance.

Forward Collision-Avoidance Assist may detect a vehicle, pedestrian or cyclist in the next lane or outside the lane when driving on a curved road.

If this occurs, Forward Collision-Avoidance Assist may unnecessarily warn the driver and control the brake. Always check the traffic conditions around the vehicle.

- Driving on an inclined road



Forward Collision-Avoidance Assist may not detect other vehicles, pedestrians or cyclists in front of you while driving uphill or downhill adversely affecting the performance of the sensors.

This may result in unnecessary warning or braking assist, or no warning or braking assist when necessary.

Also, vehicle speed may rapidly decrease when a vehicle, pedestrian or cyclist ahead is suddenly detected.

Always have your eyes on the road while driving uphill or downhill and if necessary, steer your vehicle and depress the brake pedal to reduce your driving speed in order to maintain a safe distance.

- Changing lanes

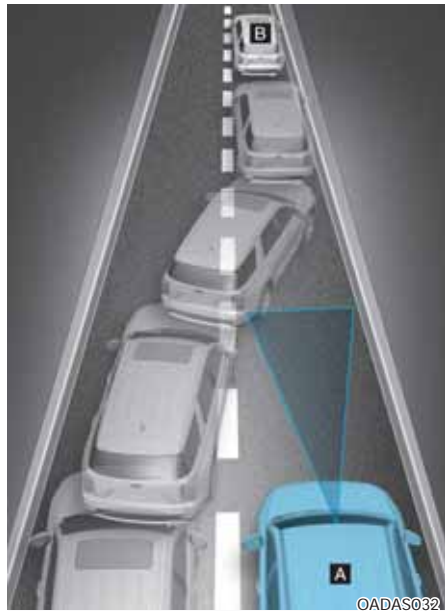

[A] : Your vehicle,
[B] : Lane changing vehicle

When a vehicle moves into your lane from an adjacent lane, it cannot be detected by the sensor until it is in the sensor's detection range. Forward Collision-Avoidance Assist may not immediately detect the vehicle when the vehicle changes lanes abruptly. In this case, you must maintain a safe braking distance, and if necessary, steer your vehicle and depress the brake pedal to reduce your driving speed in order to maintain a safe distance.



[A] : Your vehicle, [B] : Lane changing vehicle,
[C] : Same lane vehicle

When a vehicle in front of you merges out of the lane, Forward Collision-Avoidance Assist may not immediately detect the vehicle that is now in front of you. In this case, you must maintain a safe braking distance, and if necessary, steer your vehicle and depress the brake pedal to reduce your driving speed in order to maintain a safe distance.

- Detecting vehicle

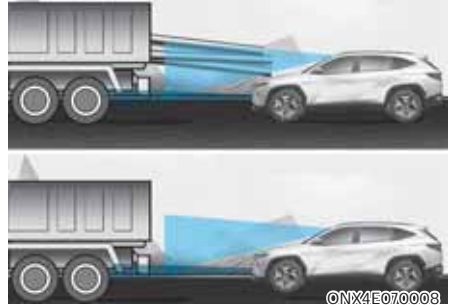

If the vehicle in front of you has cargo that extends rearward from the cab, or when the vehicle in front of you has higher ground clearance, additional special attention is required. Forward Collision-Avoidance Assist may not be able to detect the cargo extending from the vehicle. In these instances, you must maintain a safe braking distance from the rearmost object, and if necessary, steer your vehicle and depress the brake pedal to reduce your driving speed in order to maintain distance.



WARNING

- When you are towing a trailer or another vehicle, we recommend that Forward Collision-Avoidance Assist is turned off due to safety reasons.
- Forward Collision-Avoidance Assist may operate if objects that are similar in shape or characteristics to vehicles, pedestrians and cyclists are detected.
- Forward Collision-Avoidance Assist does not operate on bicycles, motorcycles, or smaller wheeled objects, such as luggage bags, shopping carts, or strollers.
- Forward Collision-Avoidance Assist may not operate normally if interfered by strong electromagnetic waves.
- Forward Collision-Avoidance Assist may not operate for 15 seconds after the vehicle is started, or the front view camera is initialized.

LANE KEEPING ASSIST (LKA) (IF EQUIPPED)

Lane Keeping Assist is designed to help detect lane markings (or road edges) while driving over a certain speed. Lane Keeping Assist will warn the driver if the vehicle leaves the lane without using the turn signal, or will automatically assist the driver's steering to help prevent the vehicle from departing the lane.

Detecting sensor



[1] : Front view camera

The front view camera is used as a detecting sensor to detect lane markings (or road edges).

Refer to the picture above for the detailed location of the detecting sensor.

CAUTION

For more details on the precautions of the front view camera, refer to "Forward Collision-Avoidance Assist (FCA)" section in chapter 7.

Lane Keeping Assist settings

Lane Safety



OOSN071028L

With the engine on, select or deselect 'Driver Assistance → Lane Safety' from the Settings menu to set whether to use each function.

- If 'Assist' is selected, Lane Keeping Assist will automatically assist the driver's steering when lane departure is detected to help prevent the vehicle from moving out of its lane.
- If 'Warning Only' is selected, Lane Keeping Assist will warn the driver with an audible warning when lane departure is detected. The driver must steer the vehicle.
- If 'Off' is selected, Lane Keeping Assist will turn off. The  indicator light will turn off on the cluster.

WARNING

- If 'Warning Only' is selected, steering is not assisted.
- Lane Keeping Assist does not control the steering wheel when the vehicle is driven in the middle of the lane.
- The driver should always be aware of the surroundings and steer the vehicle if Lane Safety is deselected.



Turning Lane Keeping Assist On/Off (Lane Driving Assist button)

With the engine on, press and hold the Lane Driving Assist button located on the steering wheel to turn on Lane Keeping Assist. The white or green  indicator light will illuminate on the cluster.

Press and hold the button again to turn off the function.

If the engine is restarted, Lane Keeping Assist will maintain the last setting.

 **CAUTION**

When the Lane Driving Assist button is pressed shortly, Lane Following Assist will turn on and deselected.

Warning Volume



With the Engine Start/Stop button in the ON position, select 'Driver Assistance → Warning Volume' from the Settings menu to change the Warning Volume to 'High', 'Medium' or 'Low' for Lane Keeping Assist.

If you change the Warning Volume, the Warning Volume of other Driver Assistance systems may change.

 **Information**

If you change the Warning Volume, the warning volume of other Driver Assistance systems may change.

Lane Keeping Assist operation

Lane Keeping Assist will warn and help control the vehicle with Lane Departure Warning and Lane Keeping Assist.

Warning and control

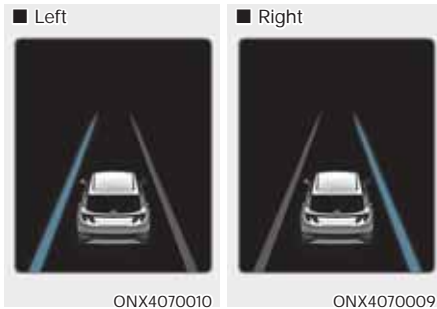

Lane Departure Warning

- To warn the driver that the vehicle is departing from the projected lane in front, the green  indicator light will blink on the cluster, the lane line will blink on the cluster depending on which direction the vehicle is veering, and an audible warning will sound.
- Lane Keeping Assist will operate when your vehicle speed is between approximately 60-200 km/h (40-120 mph).

Lane Keeping Assist

- To warn the driver that the vehicle is departing from the projected lane in front, the green  indicator light will blink on the cluster, and the steering wheel will make adjustments to keep the vehicle inside the lane.
- Lane Keeping Assist will operate when your vehicle speed is between approximately 60-200 km/h (40-120 mph).

Hands-off warning



If the driver takes their hands off the steering wheel for several seconds, the 'Place hands on the steering wheel' (or 'Keep hands on the steering wheel') warning message will appear on the cluster, and an audible warning will sound in stages.

⚠ WARNING

- The steering wheel may not be assisted if the steering wheel is held very tight or the steering wheel is steered over a certain degree.
- Lane Keeping Assist does not operate at all times. It is the responsibility of the driver to safely steer the vehicle and to maintain the vehicle in its lane.
- The hands-off warning message may appear late depending on road conditions. Always have your hands on the steering wheel while driving.
- If the steering wheel is held very lightly, the hands-off warning message may appear because Lane Keeping Assist may not recognize that the driver has their hands on the steering wheel.
- If you attach objects to the steering wheel, the hands-off warning may not work properly.

i Information

- You may change settings from the instrument cluster (User Settings) or infotainment function (Vehicle Settings), whichever option that is provided with your vehicle. For more details, see "User Settings" section in chapter 4, or "Vehicle Settings" section in supplied Infotainment Manual.
- When lane markings (or road edges) are detected, the lane lines on the cluster will change from grey to white and the green  indicator light will illuminate.

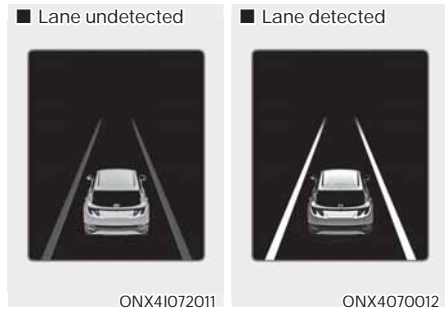

- The images and colors in the instrument cluster may differ depending on the cluster type or theme selected from the instrument cluster.
- Even though the steering is assisted by Lane Keeping Assist, the driver may control the steering wheel.
- The steering wheel may feel heavier or lighter when the steering wheel is assisted by Lane Keeping Assist than when it is not.

Lane Keeping Assist malfunction and limitations

Lane Keeping Assist malfunction



When Lane Keeping Assist is not working properly, the 'Check Lane Keeping Assist (LKA) function' warning message will appear and the yellow  indicator light will illuminate on the cluster. If this occurs, we recommend that the vehicle be inspected by an authorized HYUNDAI dealer.

Limitations of Lane Keeping Assist

Lane Keeping Assist may not operate properly or may operate unexpectedly under the following circumstances:

- The lane is contaminated or difficult to detect because:
 - The lane markings (or road edge) are covered with rain, snow, dirt, oil, etc.
 - The color of the lane marking (or road edge) is not distinguishable from the road
 - There are markings (or road edges) on the road near the lane or the markings (or road edges) on the road look similar to the lane markings (or road edge)
 - The lane marking (or road edge) is indistinct or damaged
 - The shadow is on the lane marking (or road edge) by a median strip, trees, guardrail, noise barriers, etc.
- The number of lanes change or the lanes merge
- There are more than two lane markings (or road edges) on the road
- The lane markings (or road edges) are complicated or a structure substitutes for the lines, such as a construction area
- There are road markings, such as zigzag lanes, crosswalk markings and road signs
- The lane suddenly disappears, such as at the intersection
- The lane (or road width) is very wide or narrow
- There is a road edge without a lane
- There is a boundary structure in the roadway, such as a tollgate, sidewalk, curb, etc.
- The distance to the front vehicle is extremely short or the vehicle in front is covering the lane marking (or road edge)

Information

For more details on the limitations of the front view camera, refer to “Forward Collision-Avoidance Assist (FCA)” section in chapter 7.

WARNING

Take the following precautions when using Lane Keeping Assist:

- The driver has the responsibility to safely drive and control the vehicle. Do not solely rely on Lane Keeping Assist and drive dangerously.
- The operation of Lane Keeping Assist can be cancelled or not work properly depending on road conditions and surroundings. Always be cautious while driving.
- Refer to “Limitations of Lane Keeping Assist” if the lane is not detected properly.
- When you are towing a trailer or another vehicle, we recommend that Lane Keeping Assist is turned off due to safety reasons.
- If the vehicle is driven at high speed, the steering wheel will not be controlled. The driver must always follow the speed limit when using Lane Keeping Assist.
- If any other function’s warning message is displayed or audible warning is generated, Lane Keeping Assist warning message may not be displayed and audible warning may not be generated.
- You may not hear the warning sound of Lane Keeping Assist if the surrounding is noisy.
- If you attach objects to the steering wheel, steering may not be assisted properly.
- Lane Keeping Assist may not operate for 15 seconds after the vehicle is started, or the front view camera is initialized.
- Lane Keeping Assist will not operate when:
 - The turn signal or hazard warning flasher is turned on
 - The vehicle is not driven in the center of the lane when Lane Keeping Assist is turned on or right after changing a lane
 - ESC (Electronic Stability Control) or VSM (Vehicle Stability Management) is activated
 - The vehicle is driven on a sharp curve
 - Vehicle speed is below 55 km/h (35 mph) or above 210 km/h (130 mph)
 - The vehicle makes sudden lane changes
 - The vehicle brakes suddenly

BLIND-SPOT COLLISION-AVOIDANCE ASSIST (BCA) (IF EQUIPPED)

Blind-Spot Collision-Avoidance Assist is designed to help detect and monitor approaching vehicles in the driver's blind spot area and warn the driver of a possible collision with a warning message and audible warning.

In addition, if there is a risk of collision when driving forward out of a parking space, Blind-Spot Collision-Avoidance Assist can help avoid a collision by applying the brake.

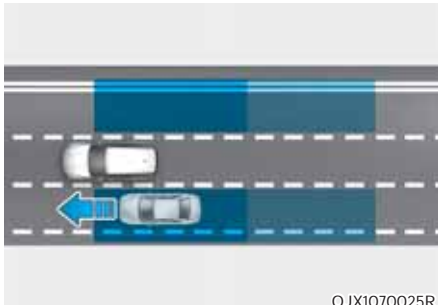

Blind-Spot Collision-Avoidance Assist helps detect and informs the driver that a vehicle is in the blind spot.

CAUTION

The detecting range may vary depending on the speed of your vehicle. Even if there is a vehicle in the blind spot area, Blind-Spot Collision-Avoidance Assist may not warn you when you pass by at high speeds.

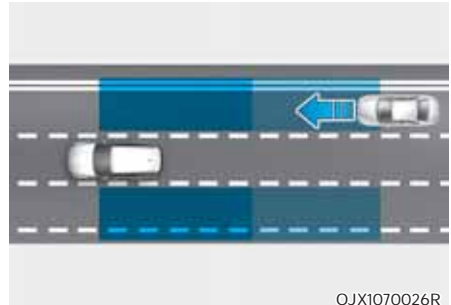

Blind-Spot Collision-Avoidance Assist helps detect and informs the driver that a vehicle is approaching at high speed from the blind spot area.

CAUTION

Warning timing may vary depending on the speed of the vehicle approaching at high speed.



When changing lanes by detecting the lane ahead, if Blind-Spot Collision-Avoidance Assist judges that there is a collision risk with an approaching vehicle in the blind spot, it can help avoid a collision by applying the brake.

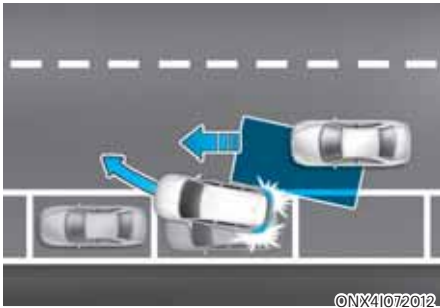

When you are driving forward out of a parking space, if Blind-Spot Collision-Avoidance Assist judges that there is a collision risk with an approaching vehicle in the blind spot, it can help avoid a collision by applying the brake.

Detecting sensor



- [1] : Front view camera,
- [2] : Rear corner radar

Refer to the picture above for the detailed location of the detecting sensors.



CAUTION

Take the following precautions to maintain optimal performance of the detecting sensor:

- Never disassemble the rear corner radar or radar assembly, or cause any damage to it.
- If the rear corner radar or near the radar has been damaged or impacted in any way, even though the warning message does not appear on the cluster, Blind-Spot Collision-Avoidance Assist may not operate properly. We recommend that the vehicle be inspected by an authorized HYUNDAI dealer.
- If the rear corner radars have been replaced or repaired, we recommend that the vehicle be inspected by an authorized HYUNDAI dealer.
- Use only genuine parts or the equivalent specified for your vehicle to repair the rear bumper where the rear corner radar is located.
- Do not apply license plate frame or objects, such as a bumper sticker, film or a bumper guard near the rear corner radar.
- Blind-Spot Collision-Avoidance Assist may not work properly if the bumper has been replaced, or the surroundings of the rear corner radar have been damaged or paint has been applied.
- If a trailer, carrier, etc., is installed, it may adversely affect the performance of the rear corner radar or Blind-Spot Collision-Avoidance Assist may not operate.
- For more details on the precautions of the front view camera, refer to "Forward Collision-Avoidance Assist (FCA)" section in chapter 7.

Blind-Spot Collision-Avoidance Assist settings

Blind-Spot Safety



OCN7N071097L

With the engine on, select or deselect 'Driver Assistance → Blind-Spot Safety' from the Settings menu to set whether or not to use each function.

- If 'Active Assist' is selected, Blind-Spot Collision-Avoidance Assist will warn the driver with a warning message, an audible warning and braking assist will be applied depending on the collision risk levels.
- If 'Warning Only' is selected, Blind-Spot Collision-Avoidance Assist will warn the driver with a warning message, an audible warning depending on the collision risk levels. Braking will not be assisted.
- If 'Off' is selected, Blind-Spot Collision-Avoidance Assist will turn off.



OTM070097N

When the engine is restarted with Blind-Spot Collision-Avoidance Assist off, the 'Blind-Spot Safety System is Off' message will appear on the cluster.

If you change the setting from 'Off' to 'Active Assist' or 'Warning Only', the warning light on the outside rearview mirror will blink for three seconds.

In addition, if the engine is turned on, when Blind-Spot Collision-Avoidance Assist is set to 'Active Assist' or 'Warning Only', the warning light on the outside rearview mirror will blink for three seconds.

 **WARNING**

If 'Blind-Spot Safety' is deselected, the driver should always be aware of the surroundings and drive safely.

 **Information**

If the engine is restarted, Blind-Spot Collision-Avoidance Assist will maintain the last setting.

Warning Timing

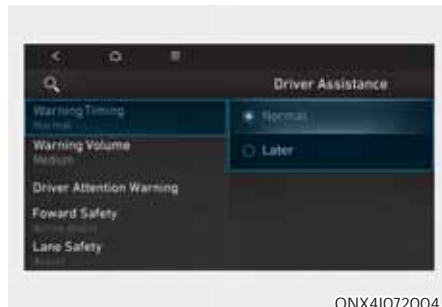

ONX4I072004

With the engine on, select 'Driver Assistance → Warning Timing' from the Settings menu to change the initial warning activation time for Blind-Spot Collision-Avoidance Assist.

When the vehicle is first delivered, Warning Timing is set to 'Normal'. If you change the Warning Timing, the warning time of other Driver Assistance systems may change.

- Use 'Normal' in normal driving conditions. If the Warning Timing seems sensitive, change it to 'Late'.
- If 'Late' is selected, Blind-Spot Collision-Avoidance Assist, warns the driver more slowly.

 **Information**

If you change the Warning Timing, the Warning Timing of other Driver Assistance systems may change.

Warning Volume



With the engine on, select 'Driver Assistance → Warning Volume' from the Settings menu to change the Warning Volume to 'High', 'Medium' or 'Low' for Blind-Spot Collision-Avoidance Assist.

If you change the Warning Volume, the Warning Volume of other Driver Assistance systems may change.



CAUTION

- The setting of the Warning Timing and Warning Volume applies to all functions of Blind-Spot Collision-Avoidance Assist.
- Even though 'Normal' is selected for Warning Timing, if a vehicle approaches at high speed, the initial warning may seem late.
- Select 'Late' for Warning Timing when traffic is light and when driving speed is slow.

Blind-Spot Collision-Avoidance Assist operation

Blind-Spot Collision-Avoidance Assist will warn and control the vehicle with Vehicle detection, Collision warning, Collision-avoidance assist.

Vehicle detection

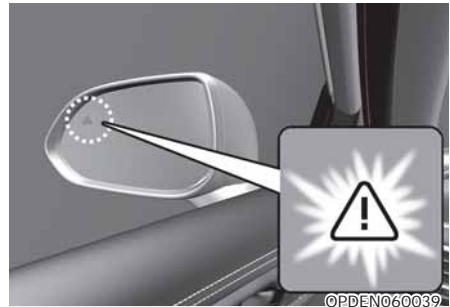

- To warn the driver a vehicle is detected, the warning light on the outside rearview mirror and head-up display (if equipped) will illuminate.
- Blind-Spot Collision-Avoidance Assist will operate when your vehicle speed is above 20 km/h (12 mph) and the speed of the vehicle in the blind spot area is above 10 km/h (7 mph).

Collision warning

- Collision warning will operate when the turn signal is turned on in the direction of the detected vehicle.
- If 'Warning Only' is selected from the Settings menu, the collision warning will operate when your vehicle approaches the lane the blind spot vehicle is detected.
- To warn the driver of a collision, the warning light on the outside rearview mirror will blink. At the same time, an audible warning will sound.
- When the turn signal is turned off, the collision warning will be cancelled and Blind-Spot Collision-Avoidance Assist will return to vehicle detection state.



WARNING

- The detecting range of the rear corner radar is determined by a standard road width, therefore, on a narrow road, Blind-Spot Collision-Avoidance Assist may detect other vehicles two lanes over and warn you. In contrast, on a wide road, Blind-Spot Collision-Avoidance Assist may not be able to detect a vehicle driving in the next lane and may not warn you.
- When the hazard warning flasher is on, the collision warning by the turn signal will not operate.



Information

- **If the driver's seat is on the left side, the collision warning may occur when you turn left. Maintain a proper distance with the vehicles in the left lane. If the driver's seat is on the right side, the collision warning may occur when you turn right. Maintain a proper distance with the vehicles in the right lane.**
- **If 'Active Assist' is selected from the Setting menu, the collision warning will operate when other vehicle approaches the lane the your vehicle.**
- **The images and colors in the instrument cluster may differ depending on the cluster type or theme selected from the settings menu.**

Collision-avoidance assist (while driving)



- To warn the driver of a collision, the warning light on the outside rearview mirror will blink and a warning message will appear on the cluster. At the same time, an audible warning will sound.
- The function will operate when your vehicle speed is between 60-200 km/h (40-120 mph) and both lane markings of the driving lane are detected.
- Emergency braking will be assisted to help prevent collision with the vehicle in the blind spot area.

WARNING

- Collision-avoidance assist will be cancelled under the following circumstances:
 - Your vehicle enters the next lane by a certain distance
 - Your vehicle is away from the collision risk
 - The steering wheel is sharply steered
 - The brake pedal is depressed
 - Forward Collision-Avoidance Assist is operating
- After Blind-Spot Collision-Avoidance Assist operation or lane change, you must drive to the center of the lane. Blind-Spot Collision-Avoidance Assist will not operate if the vehicle is not driven in the center of the lane.

Collision-avoidance assist (while departing)



- To warn the driver of a collision, the warning light on the outside rearview mirror will blink and a warning message will appear on the cluster. At the same time, an audible warning will sound.
- Blind-Spot Collision-Avoidance Assist will operate when your vehicle speed is below 3 km/h (2 mph) and the speed of the vehicle in the blind spot area is above 5 km/h (3 mph).
- Emergency braking will be assisted to help prevent collision with the vehicle in the blind spot area.



- When the vehicle is stopped due to emergency braking, the 'Drive carefully' warning message will appear on the cluster.
For your safety, the driver should depress the brake pedal immediately and check the surroundings.
- Brake control will end after the vehicle is stopped by emergency braking for approximately 2 seconds.



WARNING

Take the following precautions when using Blind-Spot Collision-Avoidance Assist:

- For your safety, only change the Settings after parking the vehicle at a safe location.
- If any other function's warning message is displayed or audible warning is generated, Blind-Spot Collision-Avoidance Assist warning message may not be displayed and audible warning may not be generated.
- You may not hear the warning sound of Blind-Spot Collision-Avoidance Assist if the surrounding is noisy.
- Blind-Spot Collision-Avoidance Assist may not operate if the driver applies the brake pedal to avoid collision.
- When Blind-Spot Collision-Avoidance Assist is operating, braking control by the function will automatically cancel when the driver excessively depresses the accelerator pedal or sharply steers the vehicle.
- During Blind-Spot Collision-Avoidance Assist operation, the vehicle may stop suddenly injuring passengers and shifting loose objects. Always have the seat belt on and keep loose objects secured.
- Even if there is a problem with Blind-Spot Collision-Avoidance Assist, the vehicle's basic braking will function normally.
- Blind-Spot Collision-Avoidance Assist does not operate in all situations or cannot avoid all collisions.

- Blind-Spot Collision-Avoidance Assist may warn the driver late or may not warn the driver depending on the road and driving conditions.
- Driver should maintain control of the vehicle at all times. Do not depend on Blind-Spot Collision-Avoidance Assist. Maintain a safe braking distance, and if necessary, depress the brake pedal to reduce driving speed or to stop the vehicle.
- Never operate Blind-Spot Collision-Avoidance Assist on people, animal, objects, etc., It may cause serious injury or death.



WARNING

The brake control may not operate properly depending on the status of ESC (Electronic Stability Control).

There will only be a warning when:

- The ESC (Electronic Stability Control) warning light is on
- ESC (Electronic Stability Control) is engaged in a different function

Blind-Spot Collision-Avoidance Assist malfunction and limitations

Blind-Spot Collision-Avoidance Assist malfunction



OTM070099N

When Blind-Spot Collision-Avoidance Assist is not working properly, the 'Check Blind-Spot Safety system(s)' warning message will appear on the cluster for several seconds, and the master  warning light will illuminate on the cluster. If this occurs, we recommend that the vehicle be inspected by an authorized HYUNDAI dealer.

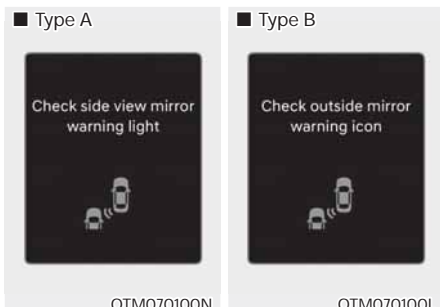

OTM070100N

OTM070100L

When the outside rearview mirror warning light is not working properly, the 'Check side view mirror warning light' (or 'Check outside mirror warning icon') warning message will appear on the cluster for several seconds, and the master  warning light will illuminate on the cluster. If this occurs, we recommend that the vehicle be inspected by an authorized HYUNDAI dealer.

Blind-Spot Collision-Avoidance Assist disabled



OTM070098N

When the rear bumper around the rear corner radar or sensor is covered with foreign material, such as snow or rain, or installing a trailer or carrier, it can reduce the detecting performance and temporarily limit or disable Blind-Spot Collision-Avoidance Assist.

If this occurs, the 'Blind-Spot Safety system(s) disabled. Radar blocked' warning message will appear on the cluster.

Blind-Spot Collision-Avoidance Assist will operate properly when such foreign material or trailer, etc., is removed, and then the engine is restarted.

If Blind-Spot Collision-Avoidance Assist does not operate properly after it is removed, we recommend that the vehicle be inspected by an authorized HYUNDAI dealer.

WARNING

- Even though the warning message does not appear on the cluster, Blind-Spot Collision-Avoidance Assist may not properly operate.
- Blind-Spot Collision-Avoidance Assist may not properly operate in an area (for example, open terrain) where any objects are not detected right after the engine is turned on, or when the detecting sensor is blocked with foreign material right after the engine is turned on.



CAUTION

Turn off Blind-Spot Collision-Avoidance Assist to install or remove a trailer, carrier, or another attachment. Turn on Blind-Spot Collision-Avoidance Assist when finished.

Limitations of Blind-Spot Collision-Avoidance Assist

Blind-Spot Collision-Avoidance Assist may not operate properly, or it may operate unexpectedly under the following circumstances:

- There is inclement weather, such as heavy snow, heavy rain, etc.
- The rear corner radar is covered with snow, rain, dirt, etc.
- The temperature around the rear corner radar is high or low
- Driving on a highway (or motorway) ramp
- The road pavement (or the peripheral ground) abnormally contains metallic components (for example, possibly due to subway construction)
- There is a fixed object near the vehicle, such as sound barriers, guardrails, central dividers, entry barriers, street lamps, signs, tunnels, walls, etc. (including double structures)
- Driving in vast areas where there are few vehicles or structures (for example, desert, meadow, suburb, etc.)
- Driving through a narrow road where trees or grass are overgrown
- Driving on a wet road surface, such as a puddle on the road
- The other vehicle drives very close behind your vehicle, or the other vehicle passes by your vehicle in close proximity
- The speed of the other vehicle is very fast that it passes by your vehicle in a short time
- Your vehicle passes by the other vehicle
- Your vehicle changes lane
- Your vehicle has started at the same time as the vehicle next to you and has accelerated
- The vehicle in the next lane moves two lanes away from you, or when the vehicle two lanes away moves to the next lane from you
- A trailer, carrier or other attachment is installed around the rear corner radar
- The bumper around the rear corner radar is covered with objects, such as a bumper sticker, bumper guard, bike rack, etc.
- The bumper around the rear corner radar is impacted, damaged or the radar is out of position
- Your vehicle height is low or high due to heavy loads, abnormal tire pressure, etc.

Blind-Spot Collision-Avoidance Assist may not operate properly, or it may operate unexpectedly when the following objects are detected:

- A motorcycle or bicycle is detected
- A vehicle such as a flat trailer is detected
- A big vehicle such as a bus or truck is detected
- A moving obstacle such as a pedestrian, animal, shopping cart or a baby stroller is detected
- A vehicle with low height such as a sports car is detected

Braking control may not work, driver's attention is required in the following circumstances:

- The vehicle severely vibrates while driving over a bumpy road, uneven road or concrete patch
- Driving on a slippery surface due to snow, water puddle, ice, etc.
- The tire pressure is low or a tire is damaged
- The braking system has been modified
- The vehicle makes abrupt lane changes

i Information

For more details on the limitations of the front view camera, refer to “Forward Collision-Avoidance Assist (FCA)” and “Lane Keeping Assist (LKA)” section in chapter 7.

⚠ WARNING

- Driving on a curved road



Blind-Spot Collision-Avoidance Assist may not operate properly when driving on a curved road. The function may not detect the vehicle in the next lane.

Always pay attention to road and driving conditions while driving.



Blind-Spot Collision-Avoidance Assist may not operate properly when driving on a curved road. The function may recognize a vehicle in the same lane.

Always pay attention to road and driving conditions while driving.

- Driving where the road is merging/dividing



Blind-Spot Collision-Avoidance Assist may not operate properly when driving where the road merges or divides. The function may not detect the vehicle in the next lane. Always pay attention to road and driving conditions while driving.

- Driving on an inclined road

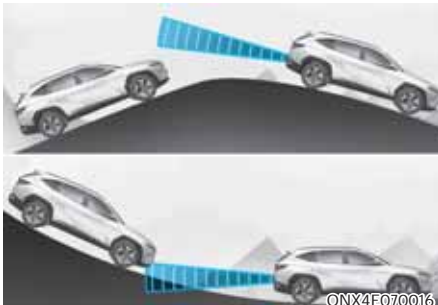

Blind-Spot Collision-Avoidance Assist may not operate properly when driving on a slope. The function may not detect the vehicle in the next lane or may incorrectly detect the ground or structure. Always pay attention to road and driving conditions while driving.

- Driving where the heights of the lanes are different

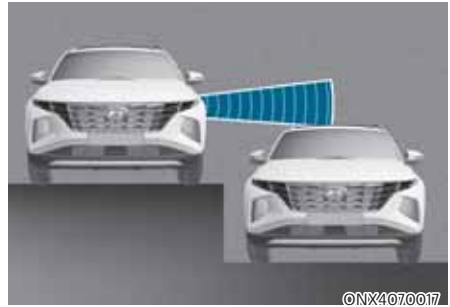

Blind-Spot Collision-Avoidance Assist may not operate properly when driving where the heights of the lanes are different. The function may not detect the vehicle on a road with different lane heights (underpass joining section, grade separated intersections, etc.).

Always pay attention to road and driving conditions while driving.

WARNING

- When you are towing a trailer or another vehicle, make sure that you turn off Blind-Spot Collision-Avoidance Assist.
- Blind-Spot Collision-Avoidance Assist may not operate properly if interfered by strong electromagnetic waves.
- Blind-Spot Collision-Avoidance Assist may not operate for 3 seconds after the vehicle is started, or rear corner radars are initialized.

SAFE EXIT WARNING (SEW) (IF EQUIPPED)

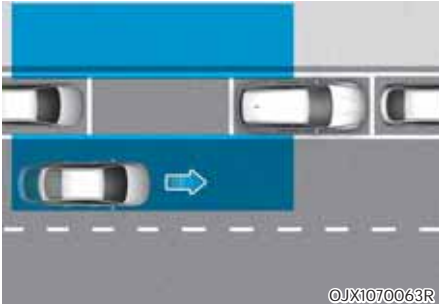

After the vehicle stops, when an approaching vehicle from the rear area is detected as soon as a passenger opens a door, Safe Exit Warning will warn the driver with a warning message and an audible warning to help prevent a collision.

CAUTION

Warning timing may vary depending on the speed of the approaching vehicle.

Detecting sensor



Refer to the picture above for the detailed location of the detecting sensors.

CAUTION

For more details on the precautions of the rear corner radars, refer to “Blind-Spot Collision Warning (BCW)” or “Blind-Spot Collision-Avoidance Assist (BCA)” section in chapter 7.

Safe Exit Warning settings

Safe Exit Warning



With the Engine Start/Stop button in the ON position, select 'Driver Assistance → Blind-Spot Safety → Safe Exit Warning' from the Settings menu to turn on Safe Exit Warning and deselect to turn off the function.

WARNING

The driver should always be aware of the surroundings. If 'Safe Exit Assist' is deselected, Safe Exit Warning cannot assist you.

Information

If the engine is restarted, Safe Exit Warning will maintain the last setting.

Warning Volume

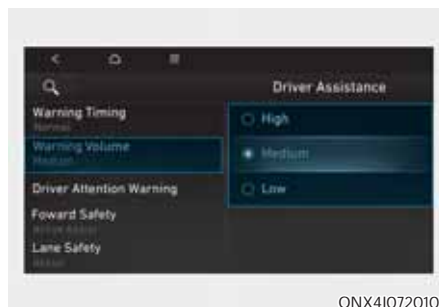

With the engine on, select 'Driver Assistance → Warning Volume' from the Settings menu to change the Warning Volume to 'High', 'Medium' or 'Low' for Safe Exit Warning.

If you change the Warning Volume, the Warning Volume of other Driver Assistance systems may change.

CAUTION

- The setting of the Warning Timing and Warning Volume applies to all functions of Safe Exit Warning.
- Even though 'Normal' is selected for Warning Timing, if the vehicle approaches at high speed from the rear, the initial warning activation time may seem late.
- Select 'Late' for Warning Timing when traffic is light and when driving speed is slow.

Safe Exit Warning operation

Collision warning when exiting vehicle



Collision warning when exiting vehicle

- When an approaching vehicle from the rear is detected at the moment a door is opened, the 'Watch for traffic' warning message will appear on the cluster, and an audible warning will sound.
- Safe Exit Warning will warn the driver when your vehicle speed is below 3 km/h (2 mph), and the speed of the approaching vehicle from the rear is above 6 km/h (4 mph).

WARNING

Take the following precautions when using Safe Exit Warning:

- For your safety, only change the Settings after parking the vehicle at a safe location.
- If any other function's warning message is displayed or audible warning is generated, Safe Exit Warning warning message may not be displayed and audible warning may not be generated.
- You may not hear the warning sound of Safe Exit Warning if the surrounding is noisy.
- Safe Exit Warning does not operate in all situations and cannot prevent all collisions.
- Safe Exit Warning may warn the driver late or may not warn the driver depending on the road and driving conditions. Always check vehicle surroundings.
- The driver and passengers are responsible for accidents that occur while exiting the vehicle. Always check the surroundings before you exit the vehicle.
- Never deliberately operate Safe Exit Warning. Doing so may lead to serious injury or death.
- Safe Exit Warning does not operate if there is a problem with Blind-Spot Collision-Avoidance Assist. The warning message of Blind-Spot Collision-Avoidance Assist will appear when:
 - Blind-Spot Collision-Avoidance Assist sensor or the sensor surrounding is polluted or covered
 - Blind-Spot Collision-Avoidance Assist fails to warn passengers or falsely warn passengers

i Information

- After the engine is turned off, Safe Exit Warning operates approximately for 3 minutes, but turns off immediately if the doors are locked.
- The images and colors in the instrument cluster may differ depending on the cluster type or theme selected from the instrument cluster.

Safe Exit Warning malfunction and limitations

Safe Exit Warning malfunction



When Safe Exit Warning is not working properly, the 'Check Blind-Spot Safety function' warning message will appear on the cluster, and the function will turn off automatically or the function will be limited. We recommend that the vehicle be inspected by an authorized HYUNDAI dealer.

Safe Exit Warning disabled



When the rear bumper around the rear corner radar or sensor is covered with foreign material, such as snow or rain, or installing a trailer or carrier, it can reduce the detecting performance and temporarily limit or disable Safe Exit Warning.

If this occurs, the 'Blind-Spot Safety system disabled. Radar blocked' warning message will appear on the cluster.

Safe Exit Warning will operate properly when such foreign material or trailer, etc., is removed, and then the engine is restarted.

If Safe Exit Warning does not operate normally after it is removed, we recommend that the vehicle be inspected by an authorized HYUNDAI dealer.

! WARNING

- Even though the warning message does not appear on the cluster, Safe Exit Warning may not properly operate.
- Safe Exit Warning may not properly operate in an area (for example, open terrain) where any objects are not detected right after the engine is turned on, or when the detecting sensor is blocked with foreign material right after the engine is turned on.



CAUTION

Turn off Safe Exit Warning to install a trailer, carrier, etc., or remove the trailer, carrier, etc., to use Safe Exit Warning.

Limitations of the Safe Exit Warning

Safe Exit Warning may not operate properly, or it may operate unexpectedly under the following circumstances:

- Getting out of the vehicle where trees or grass are overgrown
- Getting out of the vehicle where the road is wet
- The approaching vehicle is very fast or very slow



Information

For more details on the limitations of the rear corner radars, refer to “Blind-Spot Collision-Avoidance Assist (BCA)” section in chapter 7.



WARNING

- Safe Exit Warning may not operate properly if interfered by strong electromagnetic waves.
- Safe Exit Warning may not operate for 3 seconds after the vehicle is started, or rear corner radars are initialized.

MANUAL SPEED LIMIT ASSIST (MSLA) (IF EQUIPPED)

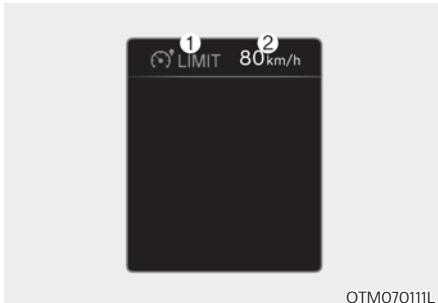

(1) Manual Speed Limit Assist enabled indicator

(2) Set speed



You can set the speed limit when you do not want to drive over a specific speed.

If you drive over the preset speed limit, Manual Speed Limit Assist operates (set speed limit will blink and chime will sound) until the vehicle speed returns within the speed limit.

Manual Speed Limit Assist operation

Setting speed limit



1. Press and hold Driving Assist () button at the desired speed. The Manual Speed Limit Assist enabled () indicator will illuminate on the cluster.

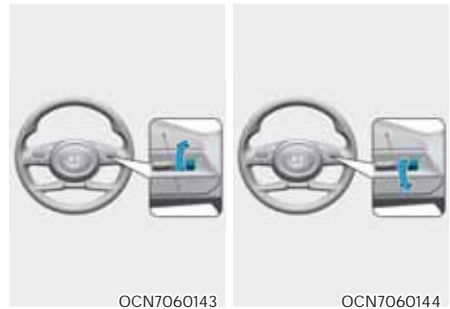

2. Push the + switch up or - switch down, and release it at the desired speed.

Push the + switch up or - switch down and hold it. The speed will increase or decrease to the nearest multiple of ten (multiple of five in mph) at first, and then increase or decrease by 10 km/h (5 mph).

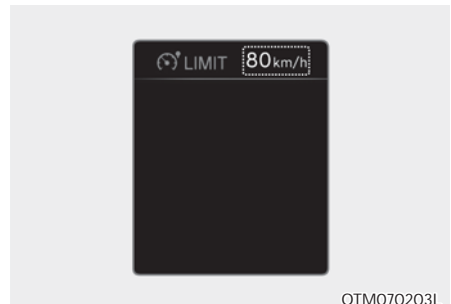

3. The set speed limit will be displayed on the cluster.

If you would like to drive over the preset speed limit, depress the accelerator pedal beyond the pressure point to activate the kickdown function.



The set speed limit will blink and chime will sound until you return the vehicle speed within the speed limit.

i Information

- When the accelerator pedal is not depressed beyond the pressure point, vehicle speed will maintain within the speed limit.
- A clicking sound may be heard from the kickdown function when the accelerator pedal is depressed beyond the pressure point.

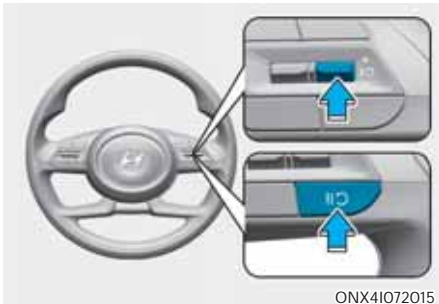
Temporarily pausing Manual Speed Limit Assist



Press the **||**  switch to temporarily pause the set speed limit. The set speed limit will turn off but the Manual Speed Limit Assist enabled (LIMIT) indicator will stay on.

Resuming Manual Speed Limit Assist

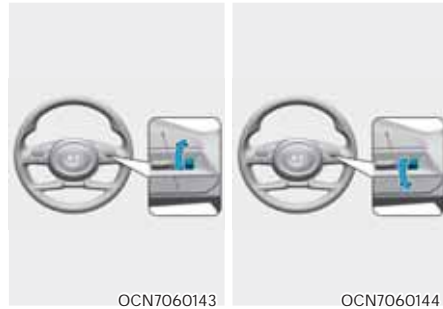

To resume Manual Speed Limit Assist after the function was paused, operate the +, -,  switch.

If you push the + switch up or – switch down, vehicle speed will be set to the current speed on the cluster.

If you press the  switch, vehicle speed will resume to the preset speed.

Turning off Manual Speed Limit Assist



Press and hold the Driving Assist (🚗) button to turn Manual Speed Limit Assist off. The Manual Speed Limit Assist enabled (🚗LIMIT) indicator will go off.

WARNING

Take the following precautions when using Manual Speed Limit Assist:

- Always set the vehicle speed under the speed limit in your country.
- Keep Manual Speed Limit Assist off when the function is not in use, to avoid inadvertently setting a speed. Check that the Manual Speed Limit Assist enabled (🚗LIMIT) indicator is off.
- Manual Speed Limit Assist does not substitute for proper and safe driving. It is the responsibility of the driver to always drive safely and be aware of unexpected and sudden situations. Pay attention to the road conditions at all times.

DRIVER ATTENTION WARNING (DAW) (IF EQUIPPED)

Basic function

Driver Attention Warning can help determine the driver's attention level by analyzing driving pattern and driving time while the vehicle is driven. Driver Attention Warning will recommend a break when the driver's attention level falls below a certain level.

Leading Vehicle Departure Alert function

Leading Vehicle Departure Alert function will inform the driver when a detected vehicle in front departs.

Detecting sensor



[1] : Front view camera

The front view camera is used to help detect driving patterns and front vehicle departure while vehicle is being driven.

Refer to the picture above for the detailed location of the detecting sensor.



CAUTION

Always keep the front view camera in good condition to maintain optimal performance of Driver Attention Warning.

For more details on the precautions of the front view camera, refer to "Forward Collision-Avoidance Assist (FCA)" section in chapter 7.

Driver Attention Warning settings

Driver Attention Warning



ONX4I072016

With the engine on, select or deselect 'Driver Assistance → Driver Attention Warning (or DAW (Driver Attention Warning))' from the Settings menu to set whether to use the function.

- If 'Inattentive Driving Warning' (or 'Swaying warning') is selected, Driver Attention Warning will inform the driver the driver's attention level and will recommend taking a break when the level falls below a certain level.

Leading Vehicle Departure Alert

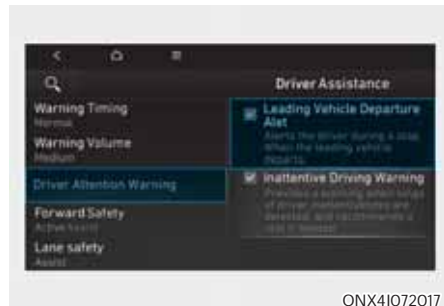

ONX4I072017

- If 'Leading Vehicle Departure Alert' is selected, the function will inform the driver when a detected vehicle in front departs from a stop.

Warning Timing



ONX4I072004

With the engine on, select 'Driver Assistance → Warning Timing' from the Settings menu to change the initial warning activation time for Driver Attention Warning.

When the vehicle is first delivered, Warning Timing is set to 'Normal'. If you change the Warning Timing, the Warning Timing of other Driver Assistance systems may change.

Information

If the engine is restarted, Driver Attention Warning will maintain the last setting.

Driver Attention Warning operation

Basic function

Display and warning

The basic function of Driver Attention Warning is to inform the driver of their 'Attention Level' and to warn the driver to 'Consider taking a break'.

Attention level



- The driver can monitor his/her driving conditions on the cluster.
 - When the 'Inattentive Driving Warning' is deselected from the Settings menu, 'System Off' is displayed.
 - Driver Attention Warning will operate when vehicle speed is between 0-200 km/h (0-120 mph).
 - When vehicle speed is not within the operating speed, the message 'Standby' (or 'Disabled') will be displayed.

- The driver's attention level is displayed on the scale of 1 to 5. The lower the level is, the more inattentive the driver is.
- The level decreases when the driver does not take a break for a certain period of time.

Taking a break



- The 'Consider taking a break' message will appear on the cluster and an audible warning will sound to suggest that the driver take a break, when the driver's attention level is below 1.
- Driver Attention Warning will not suggest a break when the total driving time is shorter than 10 minutes or 10 minutes has not passed after the last break was suggested.

WARNING

For your safety, only change the Settings after parking the vehicle at a safe location.

CAUTION

- Driver Attention Warning may suggest a break depending on the driver's driving pattern or habits, even if the driver doesn't feel fatigued.
- Driver Attention Warning is a supplemental function and may not be able to determine whether the driver is inattentive.
- A driver who feels fatigued should take a break at a safe location, even though there is no break suggestion by Driver Attention Warning.

Information

You may change settings from the instrument cluster (User Settings) or infotainment function (Vehicle Settings), whichever option that is provided with your vehicle. For more details, see "User Settings" section in chapter 4, or "Vehicle Settings" section in supplied Infotainment Manual.

Leading Vehicle Departure Alert function

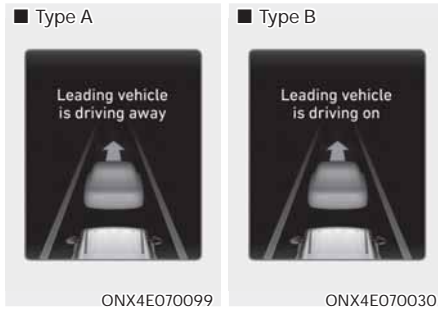

When a detected vehicle in front departs from a stop, Leading Vehicle Departure Alert will inform the driver by displaying the 'Leading vehicle is driving away' (or 'Leading vehicle is driving on') message on the cluster and an audible warning will sound.

WARNING

- If any other function's warning message is displayed or audible warning is generated, Leading Vehicle Departure Alert's warning message may not be displayed and audible warning may not be generated.
- The driver has the responsibility to safely drive and control the vehicle.

CAUTION

- Leading Vehicle Departure Alert is a supplemental function and may not alert the driver whenever the front vehicle departs from a stop.
- Always check the front of the vehicle and road conditions before departure.

Information

The images and colors in the instrument cluster may differ depending on the cluster type or theme selected from the settings

Driver Attention Warning malfunction and limitations

Driver Attention Warning malfunction

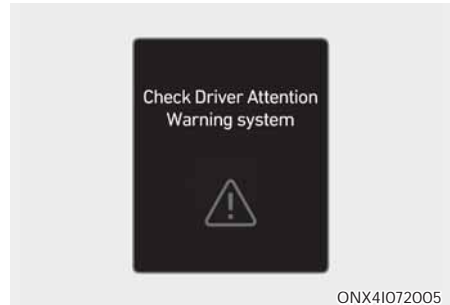

When Driver Attention Warning is not working properly, the 'Check Driver Attention Warning (DAW) system' warning message will appear on the cluster for several seconds, and the master  warning light will illuminate on the cluster. If this occurs, we recommend that the vehicle be inspected by an authorized HYUNDAI dealer.

Limitations of Driver Attention Warning

Driver Attention Warning may not work properly in the following situations:

- The vehicle is driven violently
- The vehicle intentionally crosses over lanes frequently
- The vehicle is controlled by Driver Assistance function, such as Lane Keeping Assist

Leading Vehicle Departure Alert function

- When the vehicle cuts in

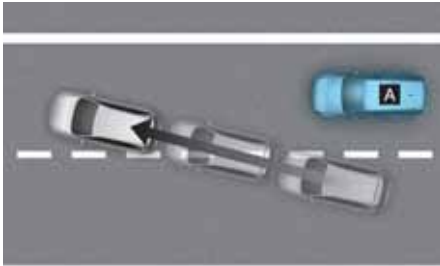

©ADAS021R



©ADAS022R

[A] : Your vehicle, [B] : Front vehicle

If a vehicle cuts in front of your vehicle, Leading Departure Alert may not operate properly.

- When the vehicle ahead sharply steers



©ADAS034R

[A] : Your vehicle, [B] : Front vehicle

If the vehicle in front makes a sharp turn, such as to turn left or right or make a U-turn, etc., Leading Vehicle Departure Alert may not operate properly.

- When the vehicle ahead abruptly departs



©ADAS024R

If the vehicle in front abruptly departs, Leading Vehicle Departure Alert may not operate properly.

- When a pedestrian or bicycle is between you and the vehicle ahead



If there is a pedestrian(s) or bicycle(s) in between you and the vehicle in front, Leading Vehicle Departure Alert may not operate properly.

- When in a parking lot

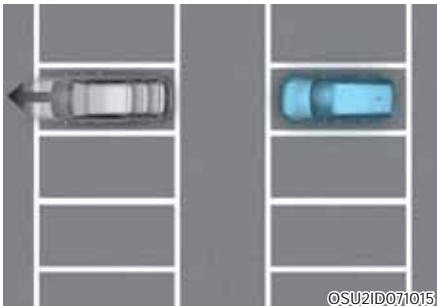

If a vehicle parked in front drives away from you, Leading Vehicle Departure Alert may alert you that the parked vehicle is driving away.

- When driving at a tollgate or intersection, etc.

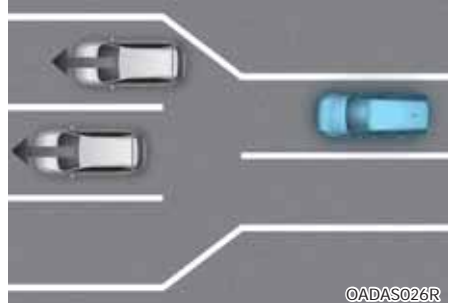

If you pass a tollgate or intersection with lots of vehicles or you drive where lanes are merged or divided frequently, Leading Vehicle Departure Alert may not operate properly.

WARNING

Driver Attention Warning may not operate for 15 seconds after the vehicle is started or function are initialized.

Information

For more details on the precautions of the front view camera, refer to “Forward Collision-Avoidance Assist (FCA)” section in chapter 7.

BLIND-SPOT VIEW MONITOR (BVM) (IF EQUIPPED)

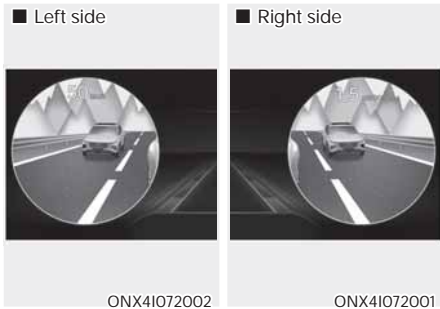

Blind-Spot View Monitor displays the rear blind spot area of the vehicle in the cluster when the turn signal is turned on to help change lanes.

Detecting sensor



[1], [2] : Wide-side view camera
(camera located at bottom of the mirror)

Refer to the picture above for the detailed location of the detecting sensors.

Blind-Spot View Monitor settings Setting features

Blind-Spot View

With the engine on, select 'Driver Assistance → Blind-Spot Safety → Blind-Spot View Monitor' from the Settings menu to turn on Blind-Spot View Monitor and deselect to turn off the function.

Blind-Spot View Monitor operation

Operating switch



Turn signal switch

Blind-Spot View Monitor will turn on and off when the turn signal is turned on and off.

Blind-Spot View Monitor

Operating conditions

When the left or right side turn signal turns on, the image in that direction is displayed on the instrument cluster.

Off conditions

- When the turn signal turns off, the image on the instrument cluster will turn off.
- When the hazard warning flasher is on, Blind-Spot View Monitor will turn off, regardless of the turn signal status.
- When other important warning is displayed on the instrument cluster, Blind-Spot View Monitor may turn off.

Blind-Spot View Monitor malfunction

When Blind-Spot View Monitor is not working properly, or the cluster display flickers, or the camera image does not display properly, we recommend that the vehicle be inspected by an authorized HYUNDAI dealer.



WARNING

- **The image shown on the cluster may differ from the actual distance of the object. Make sure to directly check the vehicle's surroundings for safety.**
- **Always keep the camera lens clean. If the lens is covered with foreign material, it may adversely affect camera performance and Blind-Spot View Monitor may not operate properly.**

CRUISE CONTROL (CC) (IF EQUIPPED)

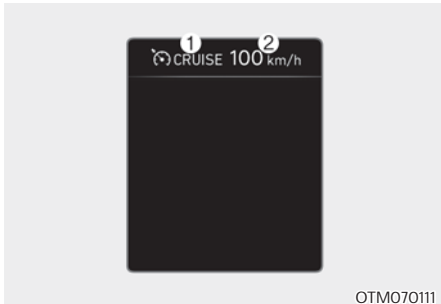

OTM070111

- (1) Cruise indicator
- (2) Set speed

Cruise Control will allow you to drive at speeds above 30 km/h (20 mph) without depressing the accelerator pedal.



Cruise Control operation

Setting set speed

1. Accelerate to the desired speed, which must be more than 30 km/h (20 mph).



ONX4070032

2. Press the Driving Assist () button at the desired speed. The set speed and Cruise (CRUISE) indicator will illuminate on the cluster.
3. Release the accelerator pedal.
Vehicle speed will maintain the set speed even when the accelerator pedal is not depressed.

Information

On a steep slope, the vehicle may slightly slow down or speed up while driving uphill or downhill.

Increasing set speed



- Push the + switch up and release it immediately. The set speed will increase by 1 km/h (1 mph) each time the switch is operated in this manner.
- Push the + switch up and hold it while monitoring the set speed on the cluster. The set speed will increase to the nearest multiple of ten (multiple of five in mph) at first, and then increase by 10 km/h (5 mph) each time the switch is operated in this manner. Release the switch when the desired speed is shown and the vehicle will accelerate to that speed.

Decreasing set speed



- Push the - switch down and release it immediately. The set speed will decrease by 1 km/h (1 mph) each time the switch is operated in this manner.
- Push the - switch down and hold it while monitoring the set speed on the cluster. The set speed will decrease to the nearest multiple of ten (multiple of five in mph) at first, and then decrease by 10 km/h (5 mph) each time the switch is operated in this manner. Release the switch at the speed you want to maintain.

Accelerating temporarily

If you want to speed up temporarily when Cruise Control is on, depress the accelerator pedal.

To return to the set speed, take your foot off the accelerator pedal.

If you push the + switch up or - switch down at increased speed, the set speed will be set to the current increased speed.

Temporarily pausing Cruise Control

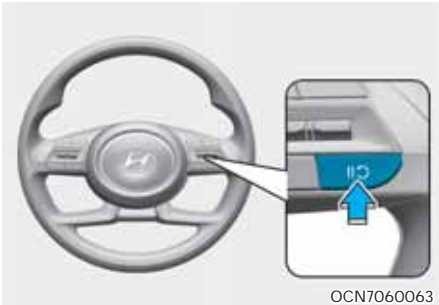

Cruise Control will be paused when:

- Depressing the brake pedal.
- Pressing the **||** **↻** button.
- Shifting the gear to N (Neutral).
- Decreasing vehicle speed to less than approximately 30 km/h (20 mph).
- ESC (Electronic Stability Control) is operating.
- Downshifting to 2nd gear when in Manual Shift mode.

The set speed will turn off but the Cruise (**||** **↻** CRUISE) indicator will stay on.

NOTICE

If Cruise Control pauses during a situation that is not mentioned, we recommend that the vehicle be inspected by an authorized HYUNDAI dealer.

Resuming Cruise Control

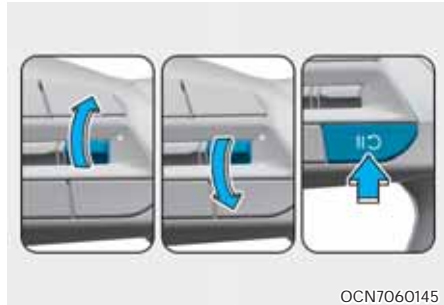

Operate the +, - switch or **||** **↻** button.

If you push the + switch up or - switch down, vehicle speed will be set to the current speed on the cluster.

If you press the **||** **↻** button, vehicle speed will resume to the preset speed.

Vehicle speed must be above 30 km/h (20 mph) for the function to resume.

WARNING

Check the driving condition before using the **||** **↻** button. Driving speed may sharply increase or decrease when you press the **||** **↻** button.

Turning off Cruise Control



Press the Driving Assist (🚗) button to turn Cruise Control off. The Cruise (CRUISE) indicator will go off.

Always press the Driving Assist button to turn Cruise Control off when not in use.

i Information

If your vehicle is equipped with Manual Speed Limit Assist, press and hold the Driving Assist (🚗) button to turn off Cruise Control. However, Manual Speed Limit Assist will turn on.

⚠ WARNING

Take the following precautions when using Cruise Control:

- Always set the vehicle speed under the speed limit in your country.
- Keep Cruise Control off when the function is not in use, to avoid inadvertently setting a speed. Check that the Cruise (CRUISE) indicator is off.
- Cruise Control does not substitute for proper and safe driving. It is the responsibility of the driver to always drive safely and should always be aware of unexpected and sudden situations from occurring.
- Always drive cautiously to prevent unexpected and sudden situations from occurring. Pay attention to the road conditions at all times.
- Do not use Cruise Control when it may be unsafe to keep the vehicle at a constant speed:
 - When driving in heavy traffic, or when traffic conditions make it difficult to drive at a constant speed
 - When driving on rainy, icy, or snow-covered roads
 - When driving on hilly or windy roads
 - When driving in windy areas
 - When driving with limited view (possibly due to bad weather, such as fog, snow, rain and sandstorm)
- Do not use Cruise Control when towing a trailer.

SMART CRUISE CONTROL (SCC) (IF EQUIPPED)

Smart Cruise Control is designed to help detect the vehicle ahead and help maintain the desired speed and minimum distance between the vehicle ahead.

Overtaking Acceleration Assist

While Smart Cruise Control is operating, if the function judges that the driver is determined to overtake the vehicle in front, acceleration will be assisted.

Detecting sensor



[1] : Front view camera,
[2] : Front radar

The front view camera and front radar are used as a detecting sensor to help detect the vehicles in front.

Refer to the picture above for the detailed location of the detecting sensor.



CAUTION

Always keep the front view camera and front radar in good condition to maintain optimal performance of Smart Cruise Control.

For more details on the precautions of the front view camera and front radar, refer to "Forward Collision-Avoidance Assist (FCA)" section in chapter 7.

Smart Cruise Control settings

Setting features



Turning on Smart Cruise Control

- Press the Driving Assist (🚗) button to turn on Smart Cruise Control. The speed will be set to the current speed on the cluster.
- If there is no vehicle in front of you, the set speed will be maintained, but if there is a vehicle in front of you, the speed may decrease to maintain the distance to the vehicle ahead. If the vehicle ahead accelerates, your vehicle will travel at a steady cruising speed after accelerating to the set speed.

i Information

- If your vehicle speed is between 0- 30 km/h (0- 20 mph) when you press the Driving Assist (🚗) button, the Smart Cruise Control speed will be set to 30 km/h (20 mph).
- Driving speed may not reach the set speed if the driver changes gears to a lower gear level.

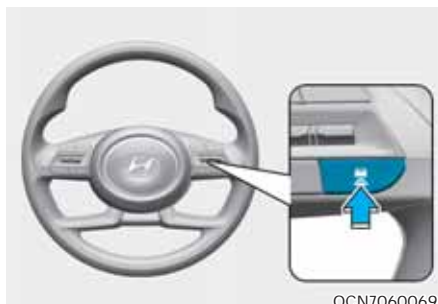

Setting vehicle distance

Each time the button is pressed, the vehicle distance changes as follows:

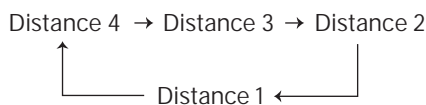

i Information

- If you drive at 90 km/h (56 mph), the distance is maintained as follows:
 - Distance 4 - approximately 52.5 m (172 ft.)
 - Distance 3 - approximately 40 m (130 ft.)
 - Distance 2 - approximately 32.5 m (106 ft.)
 - Distance 1 - approximately 25 m (82 ft.)
- The distance is set to the last set distance when the engine is restarted, or when Smart Cruise Control was temporarily cancelled.



Increasing set speed

- Push the + switch up and release it immediately. The set speed will increase by 1 km/h (1 mph) each time the switch is operated in this manner.
- Push the + switch up and hold it while monitoring the set speed on the cluster. The set speed will increase by 10 km/h or 5 mph each time the switch is operated in this manner. Release the switch when the desired speed is shown, and the vehicle will accelerate to that speed. You can set the speed to 180 km/h (110 mph).



Decreasing set speed

- Push the - switch down and release it immediately. The set speed will decrease by 1 km/h (1 mph) each time the switch is operated in this manner.
- Push the - switch down and hold it while monitoring the set speed on the cluster. The set speed will decrease by 10 km/h or 5 mph each time the switch is operated in this manner. Release the switch at the speed you want to maintain. You can set the speed to 30 km/h (20 mph).

 **WARNING**

Check the driving condition before using the + switch. Driving speed may sharply increase when you push up and hold the + switch.

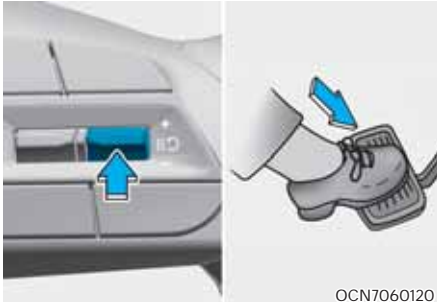

OCN7060120

Temporarily cancelling Smart Cruise Control

Press the  switch or depress the brake pedal to temporarily cancel Smart Cruise Control.

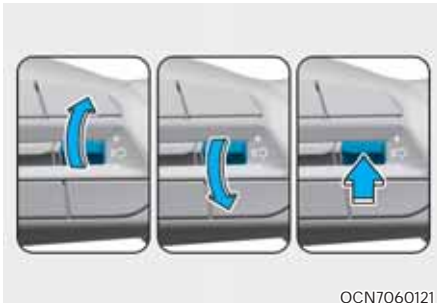

OCN7060121



Resuming Smart Cruise Control

To resume Smart Cruise Control after the function was cancelled, press the +, - or  switch.

If you push the + switch up or - switch down, vehicle speed will be set to the current speed on the cluster.

If you push the  switch, vehicle speed will resume to the preset speed.

WARNING

Check the driving condition before using the  switch. Driving speed may sharply increase or decrease when you press the  switch.



ONX4070032

Turning off Smart Cruise Control

Press the Driving Assist () button to turn Smart Cruise Control off.

Information

If your vehicle is equipped with Manual Speed Limit Assist, press and hold the Driving Assist () button to turn off Smart Cruise Control. However, Manual Speed Limit Assist will turn on.

Based on Drive Mode

Smart Cruise Control will change acceleration based on the drive mode selected from Drive Mode Integrated Control function. Refer to the following chart.

Drive mode	Smart Cruise Control
Normal	Normal
ECO	Slow
SPORT	Fast
SMART (if equipped)	Normal

Information

For more details on drive mode, refer to “Drive Mode Integrated Control System” section in chapter 6.

Warning Volume



With the engine on, select 'Driver Assistance → Warning Volume' from the Settings menu to change the Warning Volume 'High', 'Medium' or 'Low' for Smart Cruise Control.

If you change the Warning Volume, the Warning Volume of other Driver Assistance systems may change.

i Information

- **If the engine is restarted, Warning Volume will maintain the last setting.**
- **If you change the Warning Volume, the Warning Volume of other Driver Assistance systems may change.**

Smart Cruise Control operation *Operating conditions for basic function*

Smart Cruise Control will operate when the following conditions are satisfied.

Basic function

- The gear is in D (Drive)
- The driver's door is closed
- EPB (Electronic Parking Brake) is not applied
- Your vehicle speed is within the operating speed range
 - 10-180 km/h (5-110 mph): when there is no vehicle in front
 - 0-180 km/h (0-110 mph): when there is a vehicle in front
- ESC (Electronic Stability Control) or ABS (Anti-Lock Braking System) is on
- ESC (Electronic Stability Control) or ABS (Anti-Lock Braking System) is not controlling the vehicle
- Engine rpm is not in the red zone
- Forward Collision-Avoidance Assist brake control is not operating

i Information

When stopped behind another vehicle, the driver can turn on Smart Cruise Control while the brake pedal is depressed.

Operating conditions for Acceleration Assist

Overtaking Acceleration Assist will operate when the turn signal indicator is turned on to the left (left-hand drive) or turned on to the right (right-hand drive) while Smart Cruise Control is operating, and the following conditions are satisfied:

- Your vehicle speed is above 60 km/h (40 mph)
- The hazard warning flasher is off
- A vehicle is detected in front of your vehicle
- Deceleration is not needed to maintain distance with the vehicle in front



WARNING

When the turn signal indicator is turned on to the left (left-hand drive) or turned on to the right (right-hand drive) while there is a vehicle ahead, the vehicle may accelerate temporarily. Pay attention to the road conditions at all times.

Smart Cruise Control display and control

Basic function

You can see the status of the Smart Cruise Control operation in the Driving Assist mode on the cluster. Refer to "LCD Display Modes" section in chapter 4.

Smart Cruise Control will be displayed as below depending on the status of the function.



- When operating
 - (1) Whether there is a vehicle ahead and the selected distance level.
 - (2) Set speed.
 - (3) Whether there is a vehicle ahead and the target vehicle distance.



OTM070155

- When temporarily cancelled
(1) CRUISE indicator
(2) The previous set speed is shaded

Information

- **The distance of the front vehicle on the cluster is displayed according to the actual distance between your vehicle and the vehicle ahead.**
- **The target distance may vary according to the vehicle speed and the set distance level. If the vehicle speed is low, even though the vehicle distance have changed, the change of the target vehicle distance may be small.**
- **The images and colors in the instrument cluster may differ depending on the cluster type or theme selected from the instrument cluster.**

Accelerating temporarily



ONX4070034

If you press the accelerator pedal above a certain speed while Smart Cruise Control is operating, the vehicle can be speeded up temporarily without altering the set speed. The set speed, distance level and target distance will blink on the cluster while pressing the accelerator pedal above a certain speed. However, the vehicle speed may be decreased when the pressing intensity is not enough.

WARNING

Be careful when accelerating temporarily, because the speed and distance is not controlled automatically even if there is a vehicle in front of you.

Temporarily cancelling Smart Cruise Control

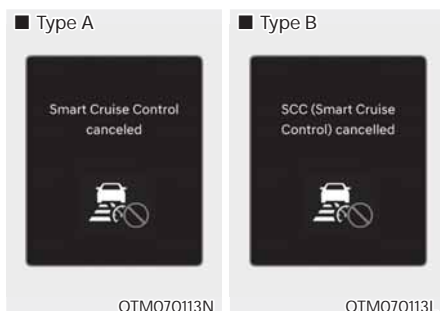

Smart Cruise Control will be temporarily cancelled automatically when:

- The vehicle speed is above 210 km/h (130 mph)
- The vehicle is stopped for a certain period of time
- The accelerator pedal is continuously depressed for a certain period of time
- The conditions for the Smart Cruise Control to operate is not satisfied

If Smart Cruise Control is temporarily cancelled automatically, the 'Smart Cruise Control canceled' (or 'SCC (Smart Cruise Control) cancelled') warning message will appear on the cluster, and an audible warning will sound to warn the driver.

i Information

If Smart Cruise Control is temporarily cancelled while the vehicle is at a standstill with the function activated, EPB (Electronic Parking Brake) maybe applied.

! WARNING

When Smart Cruise Control is temporarily cancelled, distance with the front vehicle will not be maintained. Always have your eyes on the road while driving, and if necessary, depress the brake pedal to reduce your driving speed in order to maintain a safe distance.

Smart Cruise Control conditions not satisfied

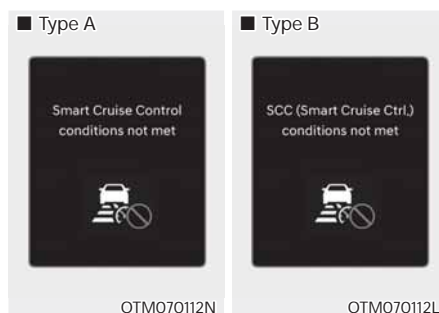

If the Driving Assist button, + switch, - switch or  switch is pushed when Smart Cruise Control operating conditions are not satisfied, the 'Smart Cruise Control conditions not met' (or 'SCC (Smart Cruise Ctrl. conditions not met') will appear on the cluster, and an audible warning will sound.

In traffic situation

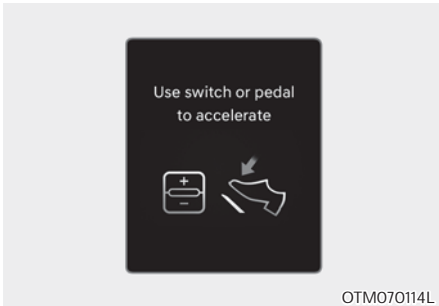

In traffic, your vehicle will stop if the vehicle ahead of you stops. Also, if the vehicle ahead of you starts moving, your vehicle will start as well. In addition, after the vehicle has stopped and a certain time have passed, the 'Use switch or pedal to accelerate' message will appear on the cluster. Depress the accelerator pedal or push the + switch, - switch or  switch to start driving.

Warning road conditions ahead



In the following situation, the 'Watch for surrounding vehicles' warning message will appear on the cluster, and an audible warning will sound to warn the driver of road conditions ahead.

WARNING

Always pay attention to vehicles or objects that may suddenly appear in front of you, and if necessary, depress the brake pedal to reduce your driving speed in order to maintain a safe distance.

Collision Warning



While Smart Cruise Control is operating, when the collision risk with the vehicle ahead is high, the 'Collision Warning' warning message will appear on the cluster, and an audible warning will sound to warn the driver. Always have your eyes on the road while driving, and if necessary, depress the brake pedal to reduce your driving speed in order to maintain a safe distance.

WARNING

In the following situations, Smart Cruise Control may not warn the driver of a collision.

- The distance from the front vehicle is near, or the vehicle speed of the front vehicle is faster or similar to your vehicle
- The speed of the front vehicle is very slow or is at a standstill
- The accelerator pedal is depressed right after Smart Cruise Control is turned on

WARNING

Take the following precautions when using Smart Cruise Control:

- Smart Cruise Control does not substitute for proper and safe driving. It is the responsibility of the driver to always check the speed and distance to the vehicle ahead.
- Smart Cruise Control may not recognize unexpected and sudden situations or complex driving situations, so always pay attention to driving conditions and control your vehicle speed.
- Keep Smart Cruise Control off when the function is not in use to avoid inadvertently setting a speed.
- Do not open the door or leave the vehicle when Smart Cruise Control is operating, even if the vehicle is stopped.
- Always be aware of the selected speed and vehicle distance.
- Keep a safe distance according to road conditions and vehicle speed. If the vehicle distance is too close during high-speed driving, a serious collision may result.
- When maintaining distance with the vehicle ahead, if the front vehicle disappears, Smart Cruise Control may suddenly accelerate to the set speed. Always be aware of unexpected and sudden situations from occurring.
- Vehicle speed may decrease on an upward slope and increase on a downward slope.
- Always be aware of situations such as when a vehicle cuts in suddenly.

- When you are towing a trailer or another vehicle, we recommend that Smart Cruise Control is turned off due to safety reasons.
- Turn off Smart Cruise Control when your vehicle is being towed.
- Smart Cruise Control may not operate properly if interfered by strong electromagnetic waves.
- Smart Cruise Control may not detect an obstacle in front and lead to a collision. Always look ahead cautiously to prevent unexpected and sudden situations from occurring.
- Vehicles moving in front of you with a frequent lane change may cause a delay in Smart Cruise Control reaction or may cause Smart Cruise Control to react to a vehicle actually in an adjacent lane. Always drive cautiously to prevent unexpected and sudden situations from occurring.
- Always be aware of the surroundings and drive safely, even though a warning message does not appear or an audible warning does not sound.
- If any other function's warning message is displayed or warning sound is generated, Smart Cruise Control warning message may not be displayed and warning sound may not be generated.
- You may not hear the warning sound of Forward Collision-Avoidance Assist if the surrounding is noisy.
- The vehicle manufacturer is not responsible for any traffic violation or accidents caused by the driver.
- Always set the vehicle speed under the speed limit in your area.

i Information

- **Smart Cruise Control may not operate for 15 seconds after the vehicle is started or the front view camera or front radar is initialized.**
- **You may hear a sound when the brake is controlled by Smart Cruise Control.**

Smart Cruise Control malfunction and limitations

Smart Cruise Control malfunction

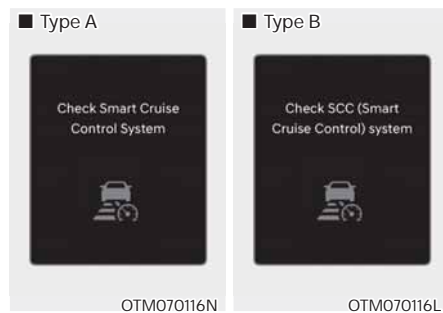

When Smart Cruise Control is not working properly, the 'Check Smart Cruise Control function' (or 'Check SCC (Smart Cruise Control) system') warning message will appear, and the  warning light will illuminate on the cluster. We recommend that the vehicle be inspected by an authorized HYUNDAI dealer.

Smart Cruise Control disabled

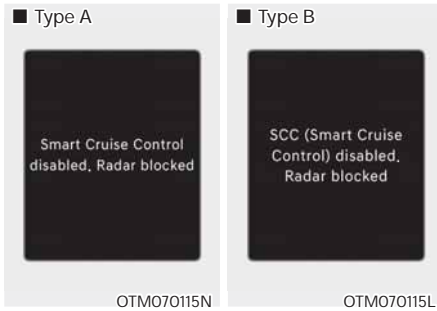

When the front radar cover or sensor is covered with snow, rain, or foreign material, it can reduce the detecting performance and temporarily limit or disable Smart Cruise Control.

If this occurs the 'Smart Cruise Control disabled. Radar blocked' (or 'SCC (Smart Cruise Control) disabled. Radar blocked') warning message will appear for a certain period of time on the cluster.

Smart Cruise Control will operate properly when snow, rain or foreign material is removed.



WARNING

Even though the warning message does not appear on the cluster, Smart Cruise Control may not properly operate.



CAUTION

Smart Cruise Control may not properly operate in an area (for example, open terrain), where any objects are not detected after turning ON the engine.

Limitations of Smart Cruise Control

Smart Cruise Control may not operate properly, or it may operate unexpectedly under the following circumstances:

- The detecting sensor or the surroundings are contaminated or damaged
- Washer fluid is continuously sprayed, or the wiper is on
- The camera lens is contaminated due to tinted, filmed or coated windshield, damaged glass, or sticky foreign material (sticker, bug, etc.) on the glass
- Moisture is not removed or frozen on the windshield
- The field of view of the front view camera is obstructed by sun glare
- Street light or light from an oncoming vehicle is reflected on the wet road surface, such as a puddle on the road
- The temperature around the front view camera is high or low
- An object is placed on the dashboard
- The surrounding is very bright
- The surrounding is very dark, such as in a tunnel, etc.
- The brightness changes suddenly, for example when entering or exiting a tunnel
- The brightness outside is low, and the headlamps are not on or are not bright
- Driving in heavy rain or snow, or thick fog
- Driving through steam, smoke or shadow

- Only part of the vehicle is detected
- The vehicle in front has no tail lights, tail lights are located unusually, etc.
- The brightness outside is low, and the tail lamps are not on or are not bright
- The rear of the front vehicle is small or does not look normal (for example, tilted, overturned, etc.)
- The front vehicle's ground clearance is low or high
- A vehicle suddenly cuts in front
- Your vehicle is being towed
- Driving through a tunnel or iron bridge
- Driving near areas containing metal substances, such as a construction zone, railroad, etc.
- An object reflecting off the front radar such as a guardrail, nearby vehicle, etc.
- The bumper around the front radar is impacted, damaged or the front radar is out of position
- The temperature around the front radar is high or low
- Driving in vast areas where there are few vehicles or structures (for example, desert, meadow, suburb, etc.)
- The vehicle in front is made of material that does not reflect on the front radar
- Driving near a highway (or motorway) interchange or tollgate
- Driving on a slippery surface due to snow, water puddle, ice, etc.
- Driving on a curved road
- The vehicle in front is detected late
- The vehicle in front is suddenly blocked by an obstacle
- The vehicle in front suddenly changes lane or suddenly reduces speed
- The vehicle in front is bent out of shape
- The front vehicle's speed is fast or slow
- With a vehicle in front, your vehicle changes lane at low speed
- The vehicle in front is covered with snow
- Unstable driving
- You are on a roundabout and the vehicle in front is not detected
- You are continuously driving in a circle
- Driving in a parking lot
- Driving through a construction area, unpaved road, partial paved road, uneven road, speed bumps, etc.
- Driving on an incline road, curved road, etc.
- Driving through a roadside with trees or streetlights
- The adverse road conditions cause excessive vehicle vibrations while driving
- Your vehicle height is low or high due to heavy loads, abnormal tire pressure, etc.
- Driving through a narrow road where trees or grass are overgrown
- There is interference by electromagnetic waves, such as driving in an area with strong radio waves or electrical noise

- Driving on a curved road



On curves, Smart Cruise Control may not detect a vehicle in the same lane, and may accelerate to the set speed. Also, vehicle speed may rapidly decrease when the vehicle ahead is detected suddenly.

Select the appropriate set speed on curves and apply the brake pedal or accelerator pedal according to the road and driving conditions ahead.



Your vehicle speed can be reduced due to a vehicle in the adjacent lane.

Apply the accelerator pedal and select the appropriate set speed. Check to be sure that the road conditions permit safe operation of the Smart Cruise Control.

- Driving on an inclined road



During uphill or downhill driving, the Smart Cruise Control may not detect a moving vehicle in your lane, and cause your vehicle to accelerate to the set speed. Also, vehicle speed will rapidly decrease when the vehicle ahead is detected suddenly.

Select the appropriate set speed on inclines and apply the brake pedal or accelerator pedal according to the road and driving conditions ahead.

- Changing lanes

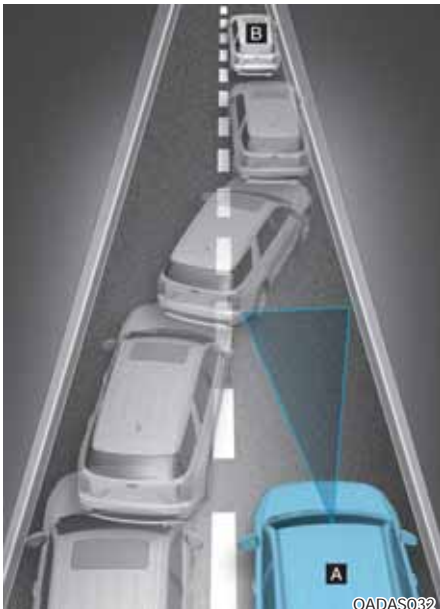

[A] : Your vehicle, [B] : Lane changing vehicle

When a vehicle moves into your lane from an adjacent lane, it cannot be detected by the sensor until it is in the sensor's detection range. Smart Cruise Control may not immediately detect the vehicle when the vehicle changes lanes abruptly. In this case, you must maintain a safe braking distance, and if necessary, depress the brake pedal to reduce your driving speed in order to maintain a safe distance.

- Detecting vehicle

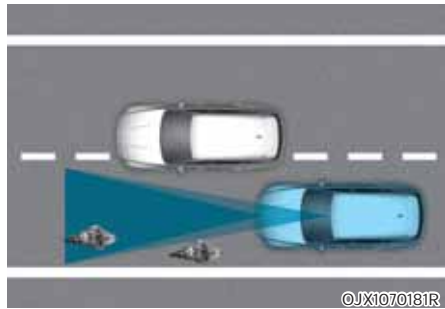

In the following cases, some vehicles in your lane cannot be detected by the sensor:

- Vehicles offset to one side
- Slow-moving vehicles or sudden-decelerating vehicles
- Oncoming vehicles
- Stopped vehicles
- Vehicles with small rear profile, such as trailers
- Narrow vehicles, such as motorcycles or bicycles
- Special vehicles
- Animals and pedestrians

Adjust your vehicle speed by depressing the brake pedal according to the road and driving conditions ahead.



In the following cases, the vehicle in front cannot be detected by the sensor:

- Vehicles with higher ground clearance or vehicles carrying loads that stick out of the back of the vehicle
- Vehicles that has the front lifted due to heavy loads
- You are steering your vehicle
- Driving on narrow or sharply curved roads

Adjust your vehicle speed by depressing the brake pedal according to the road and driving conditions ahead.



- When a vehicle ahead disappears at an intersection, your vehicle may accelerate.

Always pay attention to road and driving conditions while driving.



- When a vehicle in front of you merges out of the lane, Smart Cruise Control may not immediately detect the new vehicle that is now in front of you. Always pay attention to road and driving conditions while driving.

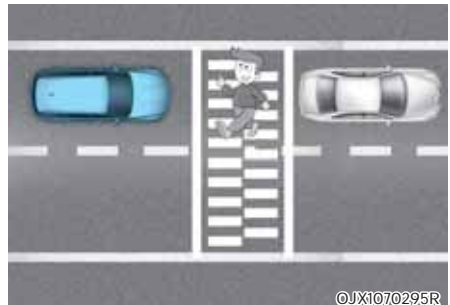

- Always look out for pedestrians when your vehicle is maintaining a distance with the vehicle ahead.

LANE FOLLOWING ASSIST (LFA) (IF EQUIPPED)

Lane Following Assist is designed to help detect lane markings and/or vehicles on the road, and assists the driver's steering to help center the vehicle in the lane.

Detecting sensor



[1] : Front view camera

The front view camera is used as a detecting sensor to help detect lane markings and vehicles in front.

Refer to the picture above for the detailed location of the detecting sensor.



CAUTION

For more details on the precautions of the front view camera, refer to "Forward Collision-Avoidance Assist (FCA)" section in chapter 7.

Lane Following Assist Operation *Turning the Lane Following Assist on/off*

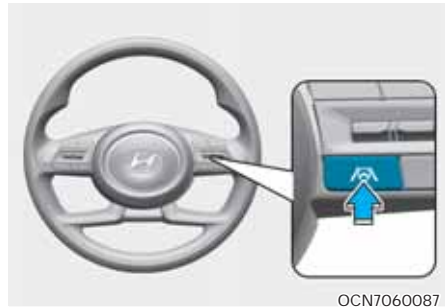

With the engine on, shortly press the Lane Driving Assist button located on the steering wheel to turn on Lane Following Assist. The white or green  indicator light will illuminate on the cluster.

Press the button again to turn off Lane Following Assist.

Warning Volume



OCN7N071092L

With the engine on, select 'Driver Assistance → Warning Volume' from the Settings menu to change the Warning Volume to 'High', 'Medium' or 'Low' for Hands-off warning.

If you change the Warning Volume, the Warning Volume of other Driver Assistance systems may change.

Lane Following Assist operation

You can press the Lane Driving Assist button turning Lane Following Assist ON/OFF. The function will warn and control the vehicle with Lane Follow Assist and hands-off warning.

Lane Following Assist



ONX4I072003

If the vehicle ahead and/or both lane markings are detected and your vehicle speed is below 180 km/h (110 mph), the green  indicator light illuminates on the cluster, and Lane Following Assist will help center the vehicle in the lane by assisting the steering wheel.



CAUTION

When the steering wheel is not assisted, the green  indicator light will blink and change to white.

Hands-off warning



If the driver takes their hands off the steering wheel for several seconds, the 'Place hands on the steering wheel' (or 'Keep hands on the steering wheel') warning message will appear and an audible warning will sound in stages.

First stage : Warning message

Second stage : Warning message (red steering wheel) and audible warning

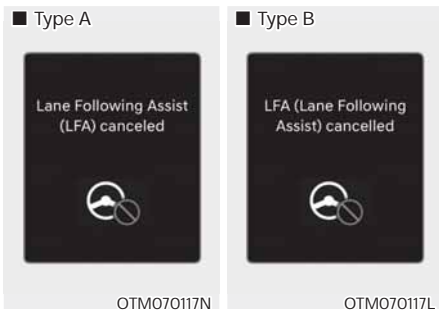

If the driver still does not have their hands on the steering wheel after the hands-off warning, the 'Lane Following Assist (LFA) canceled' warning message will appear and Lane Following Assist will be automatically cancelled.

WARNING

- The steering wheel may not be assisted if the steering wheel is held very tight or the steering wheel is steered over a certain degree.
- Lane Following Assist does not operate at all times. It is the responsibility of the driver to safely steer the vehicle and to maintain the vehicle in its lane.
- The hands-off warning message may appear late depending on road conditions. Always have your hands on the steering wheel while driving.
- If the steering wheel is held very lightly the hands-off warning message may appear because the function may not recognize that the driver has their hands on the steering wheel.
- If you attach objects to the steering wheel, the hands-off warning may not work properly.

i Information

- You may change settings from the instrument cluster (User Settings) or infotainment function (Vehicle Settings), whichever option that is provided with your vehicle. For more details, see "User Settings" section in chapter 4, or "Vehicle Settings" section in supplied Infotainment Manual.
- When the lane markings are detected, the lane lines on the cluster will change from grey to white.

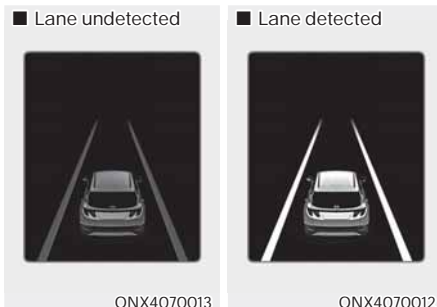

- If lane markings are not detected, steering wheel control by Lane Following Assist can be limited depending on whether a vehicle is in front or the driving conditions of the vehicle.
- Even though the steering is assisted by Lane Following Assist, the driver may control the steering wheel.
- The steering wheel may feel heavier or lighter when the steering wheel is assisted by Lane Following Assist than when it is not.
- The images and colors in the instrument cluster may differ depending on the cluster type or theme selected from the instrument cluster.

Lane Following Assist malfunction and limitations

Lane Following Assist malfunction

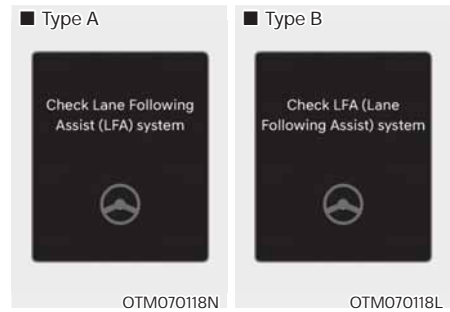

When Lane Following Assist is not working properly, the 'Check Lane Following Assist (LFA) function' (or 'Check LFA (Lane Following Assist) function') warning message will appear on the cluster for several seconds, and the master  warning light will illuminate on the cluster. If this occurs, we recommend that the vehicle be inspected by an authorized HYUNDAI dealer.

Limitations of Lane Following Assist

For more details on function limitations, refer to "Lane Keeping Assist (LKA)" section in chapter 7.

i Information

For more details on Lane Following Assist precautions, refer to "Lane Keeping Assist (LKA)" section in chapter 7.

REAR VIEW MONITOR (RVM) (IF EQUIPPED)



ONX4I052003

Rear View Monitor will show the area behind the vehicle to assist you when parking or backing up.

Detecting sensor



ONX4I072018

[1] : Rear view camera

Refer to the picture above for the detailed location of the detecting sensor.

Rear View Monitor settings *Camera settings*



ONX4I072019

You can change Rear View Monitor 'Display Contents' or 'Display Settings' by pressing the setup icon (⚙️) on the screen while Rear View Monitor is operating, or selecting 'Driver Assistance → Parking Safety → Camera Settings' from the Settings menu while the engine is on.

Rear View Monitor operation

Operating button

Parking/View button

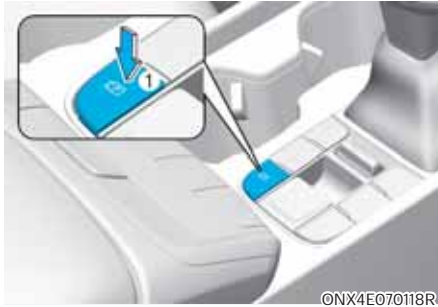

Press the Parking/View button (1) to turn on Rear View Monitor.

Press the button again to turn off the function.

Rear view

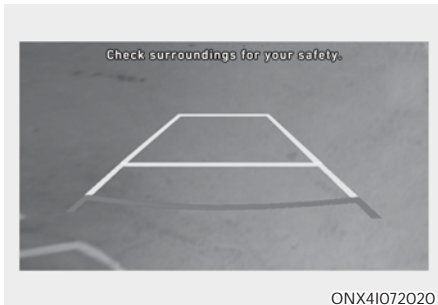

Operating conditions

- Shift the gear to R (Reverse), the image will appear on the screen.
- Press the Parking/View button (1) while the gear is in P (Park), the image will appear on the screen.

Off conditions

- The rear view cannot be turned off when the gear is in R (Reverse).
- Press the Parking/View button (1) again while the gear is in P (Park) with the rear view on the screen, the rear view will turn off.
- Shift the gear from R (Reverse) to P (Park), the rear view will turn off.

Extended Rear View Monitor

Extended Rear View Monitor function maintains showing the rear view when the gear is R (Reverse), N (Neutral) or D (Drive).

Operating conditions

The gear is in P (Park), N (Neutral) or D (Drive), and vehicle speed is 10 km/h (6 mph) or less.

Off conditions

- When vehicle speed is above 10 km/h (6 mph), the rear view will turn off.
- Shift the gear to P (Park), the rear view will turn off.
- If you press the Parking/View button (1), the screen is off.

Rear View while Driving



The driver is able to check the rear view on the screen while driving, it is to assist with safe driving.

Operating conditions

Press the Parking/View button (1) while the gear is in D (Drive) or N (Neutral), the driving rear view will appear on the screen.

Off conditions

- Press the Parking/View button (1) again, the driving rear view will turn off.
- Press one of the infotainment function button (2), the driving rear view will turn off.
- Shift the gear to P (Park), the driving rear view will turn off.

When operating

- If the gear is shifted to R (Reverse), while Driving rear view is displayed on the screen, the screen will change to rear view with parking guidance.
- When Driving rear view is displayed on the screen, an icon (1) will appear on the upper right side of the screen indicating that the rear view is being displayed.

Rear top view



When you touch the  icon, the top view is displayed on the screen and shows the distance from the vehicle in the back of your vehicle while parking.

Rear View Monitor malfunction and limitations

Rear View Monitor malfunction

When Rear View Monitor is not working properly, or the screen flickers, or the camera image does not display properly, we recommend that the vehicle be inspected by an authorized HYUNDAI dealer.

Limitations of Rear View Monitor

When the vehicle is stopped for a long time in winter or when the vehicle is parked in an indoor parking lot, the exhaust fumes may temporarily blur the image.



WARNING

- The rear view camera does not cover the complete area behind the vehicle. The driver should always check the rear area directly through the inside and outside rearview mirror before parking or backing up.
- The image shown on the screen may differ from the actual distance of the object. Make sure to directly check the vehicle's surroundings for safety.
- Always keep the rear view camera lens clean. If the lens is covered with foreign material, it may adversely affect camera performance and Rear View Monitor may not operate properly. However, do not use chemical solvents such as strong detergents containing high alkaline or volatile organic solvents (gasoline, acetone etc.). This may damage the camera lens.

SURROUND VIEW MONITOR (SVM) (IF EQUIPPED)

Surround View Monitor can assist in parking using the cameras installed on the vehicle and displays images around the vehicle through the infotainment function screen.

- Parking Assist View function helps the driver to see the surroundings of the vehicle in a parking situation in various view modes.
- Rear View while driving function helps the driver to check the rear view on the screen while driving.

Detecting sensor



- [1] : Wide-front view camera,
- [2],[3] : Wide-side view camera
(under the outside rearview mirror),
- [4] : Wide-rear view camera

Refer to the picture above for the detailed location of the detecting sensors.

Surround View Monitor settings

Camera settings

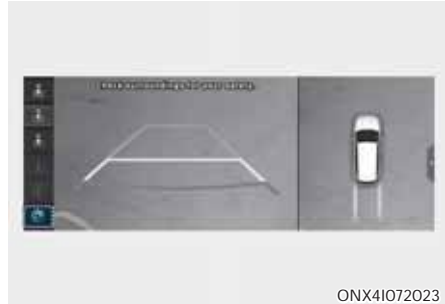

- You can change Surround View Monitor 'Display Contents' or 'Display Settings' by touching the setup icon (⚙️) on the screen while Surround View Monitor is operating, or selecting 'Driver Assistance' → 'Parking Safety' → 'Camera Settings' from the Settings menu while the engine is on.
- In the Display Contents, you can change settings for 'Top View Parking Guidance', 'Rear View Parking Guidance' and 'Parking Distance Warning'.

Top View Parking Guidance



- When the 'Top View Parking Guidance' is selected, parking guidance is displayed on the right side of the Surround View Monitor screen.
- The 'Top View Parking Guidance' can be connected with the front top view parking guidance or the rear top view parking guidance.

i Information

The horizontal guideline of the Rear Top View Parking Guidance shows the tailgate open distance of 0.5 m and 2 m from the vehicle.

Rear View Parking Guidance

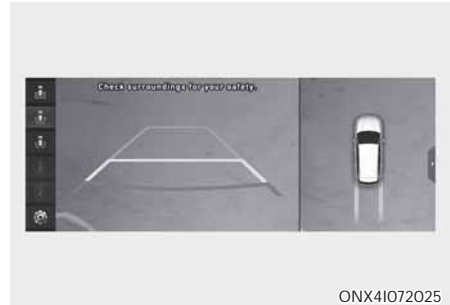

When the 'Rear View Parking Guidance' is selected, parking guidance is displayed in the rear view.

i Information

The horizontal guideline of the Rear View Parking Guidance shows the distance of 0.5 m (1.6 ft.), 1 m (3.3 ft.) and 2.3 m (7.6 ft.) from the vehicle.

Parking Distance Warning

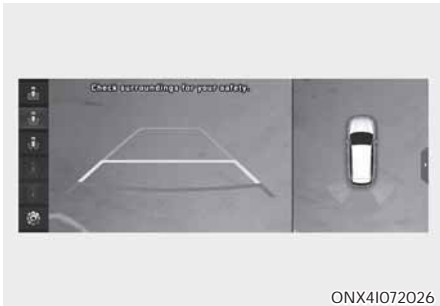

When the 'Parking Distance Warning' is selected, parking distance warning is displayed on the right side of the Surround View Monitor screen.

- The image will be displayed only when Parking Distance Warning is warning the driver.

Surround View Monitor Auto On

With the engine on, select 'Driver Assistance → Parking Safety → Surround View Monitor Auto On' from the Settings menu to use the function.

Surround View Monitor operation

Parking/View button



- Press the Parking/View button (1) to turn on Surround View Monitor. Press the button again to turn off the function.
- Other view modes can be selected by touching the view icons (2) on the Surround View Monitor screen.
- When one of the infotainment function button (3) is pressed without the gear in R (Reverse), Surround View Monitor will turn off.

Front view

The front image is displayed on the screen when the gear is in N (Neutral) or D (Drive) to assist in parking. The front view has a top view/front view/side view.

Operating conditions

- When the gear is shifted from R (Reverse) to N (Neutral) or D (Drive), the last set mode of front view function will be selected.
- Front view function will operate when the following conditions are satisfied:
 - While the infotainment function screen is being displayed, press the Parking/View button (1) briefly when the gear is in D (Drive) or N (Neutral) and vehicle speed is below 10 km/h (6 mph).
- Surround View Monitor Auto On function will operate when the following conditions are satisfied:
 - With 'Driver Assistance → Parking Safety → Surround View Monitor Auto On' selected from the Settings menu, the front parking assist view screen is displayed when Parking Distance Warning warns the driver while driving in D (Drive).

Off conditions

- Press the Parking/View button (1) again, the image will turn off.
- When vehicle speed is above 10 km/h (6 mph) with the gear in D (Drive), Surround View Monitor will turn off and the screen will change back to the previous infotainment function screen. Although you drive below 10 km/h (6 mph) again, Surround View Monitor will not turn on.
- Press one of the infotainment function button (3), the screen will change to the infotainment function screen.
- Shift the gear to P (Park), the image will turn off.

Rear view

The rear image is displayed on the screen when the gear is in R (Reverse) or P (Park) to assist in parking. The rear view has a top view/rear view/side view.

Operating conditions

- Shift the gear to R (Reverse), the image will appear on the screen.
- Press the Parking/View button (1) while the gear is in P (Park), the image will appear on the screen.

Off conditions

- The image cannot be turned off when the gear is in R (Reverse).
- Shift the gear from R (Reverse) to P (Park), the image will turn off.
- Press the Parking/View button (1) again while the gear is in P (Park) with the image on the screen.

Rear View while driving

The driver is able to check the rear view on the screen while driving, it is to assist with safe driving.

Operating conditions

- The engine is on.
- Press the Parking/View button (1) when vehicle speed is above 10 km/h (6 mph), Rear View while driving will appear on the screen.
- The  icon is touched on the Surround View Monitor screen when vehicle speed is below 10 km/h (6 mph), Rear View while driving will appear on the screen.

Off conditions

- Press the Parking/View button (1) again, the screen will change back to the previous infotainment function screen.
- Select other view modes from the Surround View Monitor screen when vehicle speed is below 10 km/h (6 mph), Rear View while driving will turn off.
- Press one of the infotainment function button (3), the screen will change to the infotainment function screen.
- Shift the gear to P (Park), Rear View while driving will turn off.

Surround View Monitor malfunction and limitations

Surround View Monitor malfunction

When Surround View Monitor is not working properly, or the screen flickers, or the camera image does not display normally, we recommend that the function be inspected by an authorized HYUNDAI dealer.

Limitations of Surround View Monitor

- When the vehicle is stopped for a long time in winter or when the vehicle is parked in an indoor parking lot, the exhaust fumes may temporarily blur the image.
- The screen may be displayed abnormally, and an icon will appear at the top left side of the screen under the following circumstances:
 - The tailgate is opened
 - The driver or front passenger door is opened
 - The outside rearview mirror is folded



WARNING

- ALWAYS look around your vehicle to make sure there are no objects or obstacles before moving the vehicle. What you see on the screen may differ from the actual vehicle's location.
- The image shown on the screen may differ from the actual distance of the object. Make sure to directly check the vehicle's surroundings for safety.
- When the rear view is displayed while driving, an icon  appears at the top right side of the Infotainment function screen to inform the driver the rear view is being displayed. Do not be confused with the front wide view image.
- Surround View Monitor is designed to be used on a flat surface. Therefore, if used on roads with different heights such as curbs and speed bumps, the image in the screen may not look correct.
- Always keep the camera lens clean. If the lens is covered with foreign material, it may adversely affect camera performance and Surround View Monitor may not operate properly. However, do not use chemical solvents such as strong detergents containing high alkaline or volatile organic solvents (gasoline, acetone etc.). This may damage the camera lens.



Information

When the Rear View while Driving function is on, it maintains irrespective of the vehicle speed. If you go backward when the Rear View while Driving is working, it alters to the rear view.

REAR CROSS-TRAFFIC COLLISION-AVOIDANCE ASSIST (RCCA) (IF EQUIPPED)

Rear Cross-Traffic Collision-Avoidance Assist is designed to help detect vehicles approaching from the rear left and right side while your vehicle is reversing, and warn the driver that a collision is imminent with a warning message and an audible warning. Also, braking is assisted to help prevent a collision.

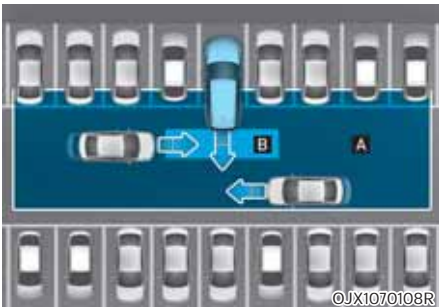

- [A] : Rear Cross-Traffic Collision Warning operating range,
- [B] : Rear Cross-Traffic Collision-Avoidance Assist operating range



CAUTION

Warning timing may vary depending on the speed of the approaching vehicle.

Detecting sensor



[1] : Rear corner radar

Refer to the picture above for the detailed location of the detecting sensors.

Information

For more details on the precautions of the rear corner radar, refer to “Blind-Spot Collision-Avoidance Assist (BCA)” section in chapter 7.

Rear Cross-Traffic Collision-Avoidance Assist settings

Rear Cross-Traffic Safety

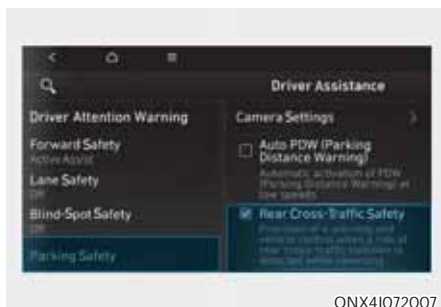

ONX41072007

With the engine on, select 'Driver Assistance → Parking Safety → Rear Cross-Traffic Safety' from the Settings menu to turn on Rear Cross-Traffic Collision-Avoidance Assist and deselect to turn off the function.

WARNING

When the engine is restarted, Rear Cross-Traffic Collision-Avoidance Assist will always turn on. However, if 'Off' is selected after the engine is restarted, the driver should always be aware of the surroundings and drive safely.

Warning Timing

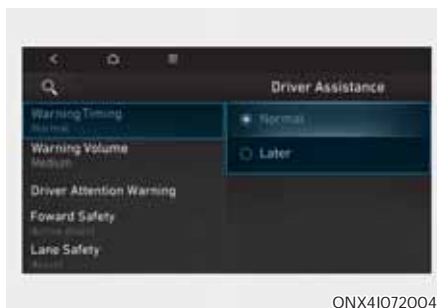

ONX41072004

With the engine on, select 'Driver Assistance → Warning Timing' from the Settings menu to change the initial warning activation time for Rear Cross-Traffic Collision-Avoidance Assist.

When the vehicle is first delivered, Warning Timing is set to 'Normal'. If you change the Warning Timing, the Warning Timing of other Driver Assistance systems may change.

Warning Volume



ONX4I072010

With the engine on, select 'Driver Assistance → Warning Volume' from the Settings menu to change the Warning Volume to 'High', 'Medium' or 'Low' for Rear Cross-Traffic Collision-Avoidance Assist.

If you change the Warning Volume, the Warning Volume of other Driver Assistance systems may change.

CAUTION

- The setting of the Warning Timing and Warning Volume applies to all functions of Rear Collision-Avoidance Assist.
- Even though 'Normal' is selected for Warning Timing, if a vehicle from the left or right side approach at high speed, the warning may seem late.
- Select 'Late' for Warning Timing when traffic is light and when driving speed is slow.

Information

If the engine is restarted, Warning Timing and Warning Volume will maintain the last setting.

Rear Cross-Traffic Collision-Avoidance Assist operation

Rear Cross-Traffic Collision-Avoidance Assist will warn and control the vehicle depending on collision level: 'Collision Warning', 'Emergency Braking' and 'Stopping vehicle and ending brake control'.

Collision Warning



- To warn the driver of an approaching vehicle from the rear left/right side of your vehicle, the outside rearview mirror will blink and a warning will appear on the cluster. At the same time, an audible warning will sound. If the Rear View Monitor is operating, a warning will also appear on the infotainment function screen.

- Rear Cross-Traffic Collision-Avoidance Assist will operate when all the following conditions are satisfied:
 - The gear is shifted to R (Reverse)
 - Vehicle speed is below 8 km/h (5 mph)
 - The approaching vehicle is within approximately 25 m (82 ft.) from the left and right side of your vehicle
 - The speed of the vehicle approaching from the left and right is above 5 km/h (3 mph)

i Information

- **If the operating conditions are satisfied, there will be a warning whenever the vehicle approaches from the left or right side even though your vehicle speed is 0 km/h (0 mph).**
- **The images and colors in the instrument cluster may differ depending on the cluster type or theme selected from the instrument cluster.**

Emergency Braking



- To warn the driver of an approaching vehicle from the rear left/right side of your vehicle, the warning light on the outside rearview mirror will blink and a warning message will appear on the cluster. At the same time, an audible warning will sound. If the Rear View Monitor is operating, a warning will also appear on the infotainment function screen.

- Rear Cross-Traffic Collision-Avoidance Assist will operate when all the following conditions are satisfied:
 - The gear is shifted to R (Reverse)
 - Vehicle speed is below 8 km/h (5 mph)
 - The approaching vehicle is within approximately 1.5 m (5 ft.) from the left and right side of your vehicle
 - The speed of the vehicle approaching from the left and right is above 5 km/h (3 mph)
- Emergency braking will be assisted to help prevent collision with approaching vehicles from the left and right.



WARNING

Brake control will end when:

- The approaching vehicle is out of the detecting range
- The approaching vehicle passes behind your vehicle
- The approaching vehicle does not drive toward your vehicle
- The approaching vehicle speed slows down
- The driver depresses the brake pedal with sufficient power

Stopping vehicle and ending brake control



- When the vehicle is stopped due to emergency braking, the 'Drive carefully' warning message will appear on the cluster.
- For your safety, the driver should depress the brake pedal immediately and check the surroundings.
- Brake control will end after the vehicle is stopped by emergency braking for approximately 2 seconds.
- During emergency braking, braking control by Rear Cross-Traffic Collision-Avoidance Assist will automatically cancel when the driver excessively depresses the brake pedal.



WARNING

Take the following precautions when using Rear Cross-Traffic Collision-Avoidance Assist:

- For your safety, only change the Settings after parking the vehicle at a safe location.
- If any other function's warning message is displayed or audible warning is generated, Rear Cross-Traffic Collision-Avoidance Assist warning message may not be displayed and/or audible warning may not be generated.
- You may not hear the warning sound of Rear Cross-Traffic Collision-Avoidance Assist if the surroundings are noisy.
- Rear Cross-Traffic Collision-Avoidance Assist may not operate if the driver applies the brake pedal to avoid collision.
- Even if there is a problem with Rear Cross-Traffic Collision-Avoidance Assist, the vehicle's basic braking will function normally.
- When Rear Cross-Traffic Collision-Avoidance Assist is operating, braking control by the function will automatically cancel when the driver excessively depresses the accelerator pedal.
- Rear Cross-Traffic Collision-Avoidance Assist does not operate in all situations or cannot avoid all collisions.
- Rear Cross-Traffic Collision-Avoidance Assist may warn the driver depending on the road and driving conditions.

- It is the driver's responsibility to control the vehicle. Do not solely depend on Rear Cross-Traffic Collision-Avoidance Assist. Rather, maintain a safe braking distance, and if necessary, depress the brake pedal to reduce driving speed or to stop the vehicle.
- Never deliberately operate Rear Cross-Traffic Collision-Avoidance Assist on people, animal, objects, etc. It may cause serious injury or death.



CAUTION

The brake control may not operate properly depending on the status of ESC (Electronic Stability Control).

There will only be a warning when:

- The ESC (Electronic Stability Control) warning light is on
- ESC (Electronic Stability Control) is engaged in a different function



Information

- **If braking is assisted by Rear Cross-Traffic Collision-Avoidance Assist, the driver must immediately depress the brake pedal and check vehicle surroundings.**
 - Brake control will end when the driver depresses the brake pedal with sufficient power.
 - After shifting the gear to R (Reverse), braking control will operate once for left and right vehicle approach.

Rear Cross-Traffic Collision-Avoidance Assist malfunction and limitations

Rear Cross-Traffic Collision-Avoidance Assist malfunction



OTM070125N

When Rear Cross-Traffic Collision-Avoidance Assist is not working properly, the 'Check Rear Cross-Traffic Safety system(s)' warning message will appear on the cluster for several seconds, and the master warning light will illuminate on the cluster. If this occurs, we recommend that the vehicle be inspected by an authorized HYUNDAI dealer.

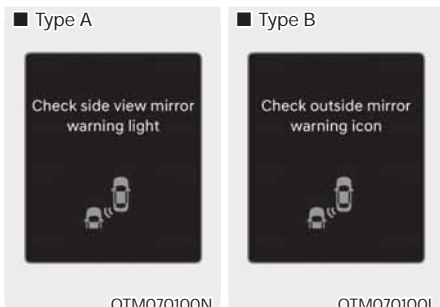

OTM070100N

OTM070100L

When the outside rearview mirror warning light is not working properly, the 'Check side view mirror warning light' (or 'Check outside mirror warning icon') warning message will appear on the cluster for several seconds, and the master warning light will illuminate on the cluster. If this occurs, we recommend that the vehicle be inspected by an authorized HYUNDAI dealer.

Rear Cross-Traffic Collision-Avoidance Assist disabled

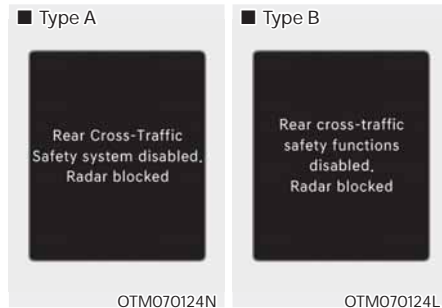

OTM070124N

OTM070124L

When the rear bumper around the rear-side radar or sensor is covered with foreign material, such as snow or rain, or installing a trailer or carrier, it can reduce the detecting performance and temporarily limit or disable Rear Cross-Traffic Collision-Avoidance Assist.

If this occurs, the 'Rear Cross-Traffic Safety function disabled. Radar blocked' (or 'Rear cross-traffic safety functions disabled. Radar blocked') warning message will appear on the cluster.

Rear Cross-Traffic Collision-Avoidance Assist will operate properly when such foreign material or trailer, etc., is removed.

If Rear Cross-Traffic Collision-Avoidance Assist does not operate properly after it is removed, we recommend that the vehicle be inspected by an authorized HYUNDAI dealer.

WARNING

- Even though the warning message does not appear on the cluster, Rear Cross-Traffic Collision-Avoidance Assist may not operate properly.
- Rear Cross-Traffic Collision-Avoidance Assist may not operate properly in an area (for example, open terrain), where any substance are not detected after turning ON the engine.

CAUTION

Turn off Rear Cross-Traffic Collision-Avoidance Assist to install or remove a trailer, carrier, or another attachment. Turn on Rear Cross-Traffic Collision-Avoidance Assist when finished.

Limitations of the Rear Cross-Traffic Collision-Avoidance Assist

Rear Cross-Traffic Collision-Avoidance Assist may not operate properly, or it may operate unexpectedly under the following circumstances:

- Departing from where trees or grass are overgrown
- Departing from where roads are wet
- Speed of the approaching vehicle is fast or slow

Braking control may not work, driver's attention is required in the following circumstances:

- The vehicle severely vibrates while driving over a bumpy road, uneven road or concrete patch
- Driving on a slippery surface due to snow, water puddle, ice, etc.
- The tire pressure is low or a tire is damaged
- The braking system has been modified
- Remote Smart Parking Assist is operating (if equipped)

Information

For more details on the limitations of the rear corner radar, refer to “Blind-Spot Collision-Avoidance Assist (BCA)” section in chapter 7.

WARNING

- Driving near a vehicle or structure

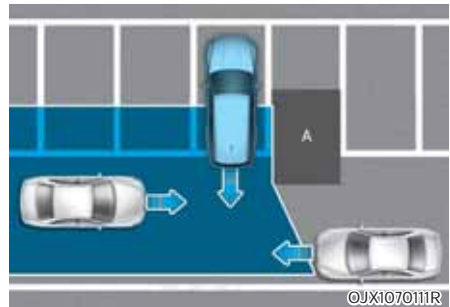

[A] : Structure

Rear Cross-Traffic Collision-Avoidance Assist may be limited when driving near a vehicle or structure, and may not detect the vehicle approaching from the left or right. If this occurs, the function may not warn the driver or control the brakes when necessary.

Always check your surroundings while backing up.

- When the vehicle is in a complex parking environment

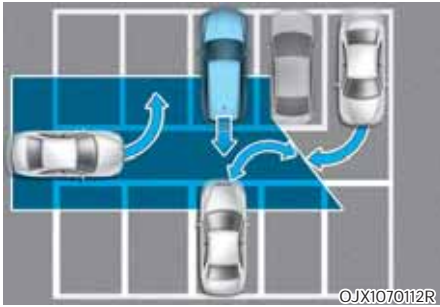

Rear Cross-Traffic Collision-Avoidance Assist may detect vehicles which are parking or pulling out near your vehicle (for example, a vehicle leaving beside your vehicle, a vehicle parking or pulling out in the rear area, a vehicle approaching your vehicle making a turn, etc.). If this occurs, the function may unnecessarily warn the driver and control the brake. Always check your surroundings while backing up.

- When the vehicle is parked diagonally



[A] : Vehicle

Rear Cross-Traffic Collision-Avoidance Assist may be limited when backing up diagonally, and may not detect the vehicle approaching from the left or right. If this occurs, the function may not warn the driver or control the brakes when necessary. Always check your surroundings while backing up.

- When the vehicle is on or near a slope

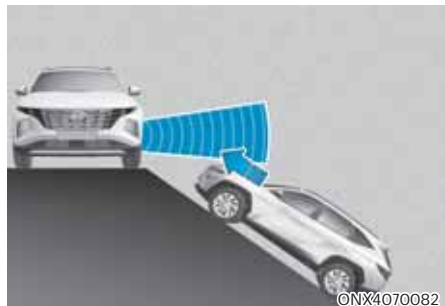

Rear Cross-Traffic Collision-Avoidance Assist may be limited when the vehicle is on an uphill or downhill slope, or near it, and may not detect the vehicle approaching from the left or right. If this occurs, the function may not warn the driver or control the brakes when necessary. Always check your surroundings while backing up.

- Pulling into the parking space where there is a structure

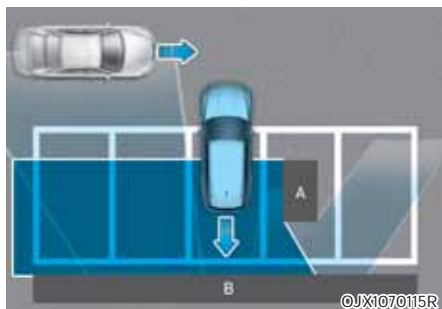

[A] : Structure, [B] : Wall

Rear Cross-Traffic Collision-Avoidance Assist may detect vehicles passing by in front of you when parking in reverse into a parking space with a wall or structure in the rear or side area. If this occurs, the function may unnecessarily warn the driver and control the brake.

Always check your surroundings while backing up.

- When the vehicle is parked rearward

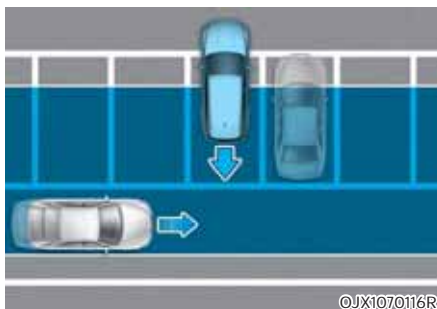

@JX1070116R

Rear Cross-Traffic Collision-Avoidance Assist may detect vehicles passing by behind you when parking in reverse into a parking space. If this occurs, the function may unnecessarily warn the driver and control the brake.

Always check your surroundings while backing up.

WARNING

- When you are towing a trailer or another vehicle, we recommend that Rear Cross-Traffic Collision-Avoidance Assist is turned off due to safety reasons.
- Rear Cross-Traffic Collision-Avoidance Assist may not operate properly if interfered by strong electromagnetic waves.
- Rear Cross-Traffic Collision-Avoidance Assist may not operate for 3 seconds after the vehicle is started, or the rear corner radars are initialized.

REVERSE PARKING DISTANCE WARNING (PDW) (IF EQUIPPED)

Reverse Parking Distance Warning can help warn the driver if an obstacle is detected within a certain distance when the vehicle is moving in reverse at low speeds.

Detecting sensor



[2] : Rear ultrasonic sensors

Refer to the picture above for the detailed location of the detecting sensors.

Reverse Parking Distance Warning settings

Warning Volume

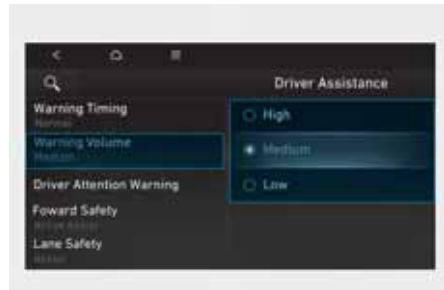

ONX41072010

With the engine on, select 'Driver Assistance → Warning Volume' from the Settings menu to change the Warning Volume to 'High', 'Medium' or 'Low' for Reverse Parking Distance Warning.

If you change the Warning Volume, the Warning Volume of other Driver Assistance systems may change.



i Information

If you change the Warning volume, the Warning volume of other Driver Assistance systems may change.

Reverse Parking Distance Warning operation

Reverse Parking Distance Warning

- Reverse Parking Distance Warning will operate when the gear is in R (Reverse).
- Reverse Parking Distance Warning helps detect a person, animal or object in the rear when the vehicle's rearward speed is below 10 km/h (6 mph).

Distance from object	Warning indicator when driving backward	Warning sound
60-120 cm (24-48 in.)		Buzzer beeps intermittently
30-60 cm (12-24 in.)		Beeps more frequently
within 30 cm (12 in.)		Beeps continuously

- The corresponding indicator will illuminate whenever each ultrasonic sensor detects a person, animal or object in its sensing range. Also an audible warning will sound.
- When more than two objects are detected at the same time, the closest one will be warned with an audible warning.
- The shape of the indicator in the illustration may differ from the actual vehicle.

Reverse Parking Distance Warning malfunction and limitations

Reverse Parking Distance Warning malfunction

After starting the engine, a beep will sound when the gear is shifted to R (Reverse) to indicate Reverse Parking Distance Warning is operating properly.

However, if one or more of the following occurs, first check whether the ultrasonic sensor is damaged or blocked with foreign material. If it still does not work properly, we recommend that the vehicle be inspected by an authorized HYUNDAI dealer.

- The audible warning does not sound.
- The buzzer sounds intermittently.
- The 'Parking sensor error or blockage' warning message appears on the cluster.





WARNING

- Reverse Parking Distance Warning is a supplemental function. The operation of Reverse Parking Distance Warning can be affected by several factors (including environmental conditions). It is the responsibility of the driver to always check the rear view before and while parking.
- Your new vehicle warranty does not cover any accidents or damage to the vehicle due to the malfunction of Reverse Parking Distance Warning.
- Pay close attention when driving near objects, pedestrians, and especially children. Some objects may not be detected by the ultrasonic sensors, due to the objects distance, size or material, all of which can limit the effectiveness of the sensor.

Limitations of Reverse Parking Distance Warning

- Reverse Parking Distance Warning may not operate properly when:
 - Moisture is frozen to the sensor
 - Sensor is covered with foreign substance, such as snow or water (Reverse Parking Distance Warning will operate properly when such foreign material are removed.)
 - The weather is extremely hot or cold
 - The sensor or sensor assembly is disassembled
 - The surface of the sensor is pressed hard or an impact is applied with a hard object
 - The surface of the sensor is scratched with a sharp object
 - The sensors or its surrounding area is directly sprayed with high pressure washer
- Reverse Parking Distance Warning may malfunction when:
 - Heavy rain or water spray is present
 - Water flows on the surface of the sensor
 - Affected by another vehicle's sensors
 - The sensor is covered with snow
 - Driving on uneven road, gravel roads or bushes
 - Objects that generates ultrasonic waves are near the sensor
 - Installing the license plate differently from the original location
 - The vehicle bumper height or ultrasonic sensor installation has been modified
 - Attaching equipments or accessories around the ultrasonic sensors

- The following objects may not be detected:
 - Sharp or slim objects, such as ropes, chains or small poles.
 - Objects, which tend to absorb sensor frequency, such as clothes, spongy material or snow.
 - Objects smaller than 100 cm (40 in.) in length and narrower than 14 cm (6 in.) in diameter.
 - Pedestrians, animals or objects that are very close to the ultrasonic sensors
- Parking Distance Warning Indicators may be displayed differently from the actual detected location when the obstacle is located between the sensors.
- Parking Distance Warning indicator may not occur sequentially depending on vehicle speed or obstacle shape.
- If Reverse Parking Distance Warning needs repair, we recommend that the vehicle be inspected by an authorized HYUNDAI dealer.

FORWARD/REVERSE PARKING DISTANCE WARNING (PDW) (IF EQUIPPED)

Forward/Reverse Parking Distance Warning can help warn the driver if an obstacle is detected within a certain distance when the vehicle is moving forward or in reverse at low speeds.

Detecting sensor



[1] : Front ultrasonic sensors

[2] : Rear ultrasonic sensors

Refer to the picture above for the detailed location of the detecting sensors.

Forward/Reverse Parking Distance Warning settings

Warning Volume

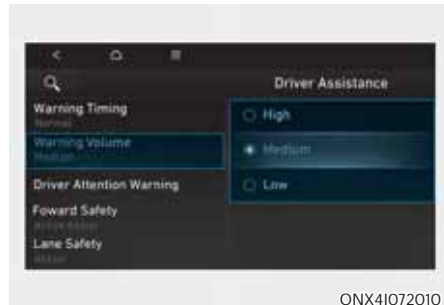

With the engine on, select 'Driver Assistance → Warning Volume' from the Settings menu to change the Warning Volume to 'High', 'Medium' or 'Low' for Forward/Reverse Parking Distance Warning.

If you change the Warning Volume, the Warning Volume of other Driver Assistance systems may change.

Parking Distance Warning Auto On





To use Parking Distance Warning Auto On function, select 'Driver Assistance → Parking Safety → Parking Distance Warning Auto On' from the cluster or infotainment function Settings menu.

When Parking Distance Warning Auto On is selected, the Parking Safety button indicator (P) stays on.

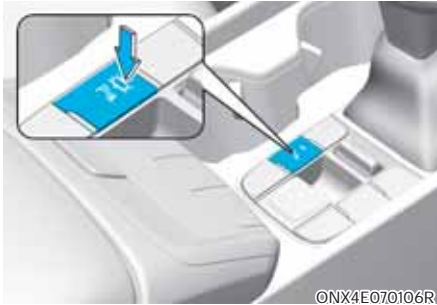

Forward/Reverse Parking Distance Warning operation

Parking Safety button



- Press the Parking Safety (P ) button to turn on Forward/Reverse Parking Distance Warning. Press the button again to turn off the function.
 - When Forward/Reverse Parking Distance Warning is off (button indicator light off), if you shift the gear to R (Reverse), Forward/Reverse Parking Distance Warning will automatically turn on.
 - When Forward/Reverse Parking Distance Warning turns on, the button indicator light will turn on. If vehicle speed is above 30km/h (18mph), Forward/Reverse Parking Distance Warning will turn off (button indicator light off).
- ### Forward Parking Distance Warning
- Forward Parking Distance Warning will operate when one of the condition is satisfied.
 - The gear is shifted from R (Reverse) to other driving gears with Reverse Parking Distance Warning on
 - The gear is not in R (Reverse) and the Parking safety (P ) button indicator light is on
 - 'Parking Distance Warning Auto On' is selected from the Settings menu and the gear is not in R (Reverse)
 - Forward Parking Distance Warning helps detect a person, animal or object in front when the vehicle's forward speed is below 10 km/h (6 mph).
 - Forward Parking Distance Warning does not operate when the vehicle's forward speed is above 10 km/h (6 mph) even when the Parking Safety (P ) button indicator is on. Forward Parking Distance Warning will operate again when the vehicle's forward speed decreases below 10 km/h (6 mph) while the Parking Safety (P ) button indicator is on.
 - When 'Parking Distance Warning Auto On' is selected, the Parking Safety (P ) button indicator light stays on.



- When 'Parking Distance Warning Auto On' is deselected, and the vehicle's forward speed is above 30km/h (18mph), the Parking Safety (P) button indicator will turn off. Although you drive below 10 km/h (6 mph), Forward Parking Distance Warning will not turn on.

Distance from object	Warning indicator when driving forward	Warning sound
60-100 cm (24-40 in.)		Buzzer beeps intermittently
30-60 cm (12-24 in.)		Beeps more frequently
within 30 cm (12 in.)		Beeps continuously

- The corresponding indicator will illuminate whenever each ultrasonic sensor detects a person, animal or object in its sensing range. Also an audible warning will sound.
- When more than two objects are detected at the same time, the closest one will be warned with an audible warning.
- The shape of the indicator in the illustration may differ from the actual vehicle.

Reverse Parking Distance Warning

- Reverse Parking Distance Warning will operate when the gear is in R (Reverse).
- Reverse Parking Distance Warning helps detect a person, animal or object in the rear when the vehicle's rearward speed is below 10 km/h (6 mph).
- When the vehicle's rearward speed is below 10 km/h (6 mph), both the front and rear ultrasonic sensors will help detect objects. However, the front ultrasonic sensors can help detect a person, animal or object when it is within 60 cm (24 in.) from the sensors.

Distance from object	Warning indicator when driving backward	Warning sound
60-120 cm (24-48 in.)		Buzzer beeps intermittently
30-60 cm (12-24 in.)		Beeps more frequently
within 30 cm (12 in.)		Beeps continuously

- The corresponding indicator will illuminate whenever each ultrasonic sensor detects a person, animal or object in its sensing range. Also an audible warning will sound.
- When more than two objects are detected at the same time, the closest one will be warned with an audible warning.
- The shape of the indicator in the illustration may differ from the actual vehicle.

Forward/Reverse Parking Distance Warning malfunction and limitations

Forward/Reverse Parking Distance Warning malfunction

After starting the engine, a beep will sound when the gear is shifted to R (Reverse) to indicate Forward/Reverse Parking Distance Warning is operating properly.

However, if one or more of the following occurs, first check whether the ultrasonic sensor is damaged or blocked with foreign material. If it still does not work properly, we recommend that the vehicle be inspected by an authorized HYUNDAI dealer.

- The audible warning does not sound.
- The buzzer sounds intermittently.
- The 'Parking sensor error or blockage' warning message appears on the cluster.



ONX4E070062



WARNING

- Forward/Reverse Parking Distance Warning is a supplemental function. The operation of Forward/Reverse Parking Distance Warning can be affected by several factors (including environmental conditions). It is the responsibility of the driver to always check the front and rear views before and while parking.
- Your new vehicle warranty does not cover any accidents or damage to the vehicle due to the malfunction of Forward/Reverse Parking Distance Warning.
- Pay close attention when driving near objects, pedestrians, and especially children. Some objects may not be detected by the ultrasonic sensors, due to the objects distance, size or material, all of which can limit the effectiveness of the sensor.

Limitations of Forward/Reverse Parking Distance Warning

- Forward/Reverse Parking Distance Warning may not operate properly when:
 - Moisture is frozen to the sensor
 - Sensor is covered with substance, such as snow or water (Forward/Reverse Parking Distance Warning will operate properly when such substance is removed.)
 - The weather is extremely hot or cold
 - The sensor or sensor assembly is disassembled
 - The surface of the sensor is pressed hard or hit with a hard object
 - The surface of the sensor is scratched with a sharp object
 - The sensors or its surrounding area is directly sprayed with high pressure washer
- Forward/Reverse Parking Distance Warning may malfunction when:
 - Heavy rain or water spray is present
 - Water flows on the surface of the sensor
 - Affected by another vehicle's sensors
 - The sensor is covered with snow or ice
 - Driving on uneven road, gravel roads or bushes
 - Objects that generates ultrasonic waves are near the sensor
 - License plate is installed in a different spot from the original location
 - The vehicle bumper height or ultrasonic sensor installation has been modified
 - Attaching equipment or accessories next to the ultrasonic sensors
- The following objects may not be detected:
 - Sharp or slim objects, such as ropes, chains or small poles.
 - Objects, which tend to absorb sensor frequency, such as clothes, spongy material or snow.
 - Objects smaller than 100 cm (40 in.) in length and narrower than 14 cm (6 in.) in diameter.
 - Pedestrians, animals or objects that are very close to the ultrasonic sensors
- Parking Distance Warning Indicators may be displayed differently from the actual detected location when the obstacle is located between the sensors.
- Parking Distance Warning indicator may not occur sequentially depending on vehicle speed or obstacle shape.
- If Forward/Reverse Parking Distance Warning needs repair, we recommend that the vehicle be inspected by an authorized HYUNDAI dealer.

8. Emergency Situations

Hazard warning flasher.....	8-2
In case of an emergency while driving.....	8-2
If the engine stalls while driving.....	8-2
If the engine stalls at a crossroad or crossing.....	8-2
If you have a flat tire while driving.....	8-3
If the engine will not start.....	8-3
Jump starting.....	8-4
If the engine overheats.....	8-7
Tire Pressure Monitoring System (TPMS).....	8-9
Check tire pressure.....	8-9
Tire pressure monitoring system.....	8-10
Low tire pressure warning light.....	8-11
Low tire pressure position and tire pressure telltale.....	8-11
TPMS (Tire Pressure Monitoring System) malfunction indicator.....	8-12
Changing a tire with TPMS.....	8-12
If you have a flat tire (with spare tire).....	8-14
Jack and tools.....	8-14
Changing tires.....	8-15
Jack label.....	8-20
EC declaration of conformity for jack.....	8-21
If you have a flat tire (with Tire Mobility Kit).....	8-22
Introduction.....	8-22
Notes on the safe use of the Tire Mobility Kit.....	8-23
Components of the Tire Mobility Kit.....	8-24
Using the Tire Mobility Kit.....	8-25
Checking the tire inflation pressure.....	8-28
Towing.....	8-30
Towing service.....	8-30
Removable towing hook.....	8-31
Emergency towing.....	8-32
Emergency commodity.....	8-34
Fire extinguisher.....	8-34
First aid kit.....	8-34
Triangle reflector.....	8-34
Tire pressure gauge.....	8-34

HAZARD WARNING FLASHER

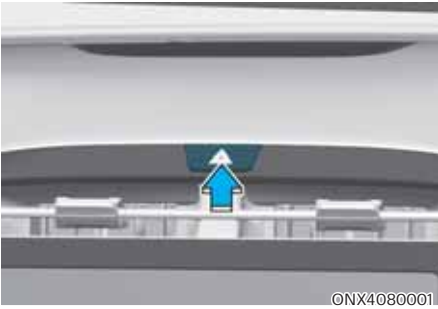

The hazard warning flasher serves as a warning to other drivers to exercise extreme caution when approaching, overtaking, or passing your vehicle. It should be used whenever emergency repairs are being made or when the vehicle is stopped near the edge of a roadway.

To turn the hazard warning flasher on or off, press the hazard warning flasher button with the ignition key or Engine start/stop button in any position. The hazard warning flasher button is located in the center fascia panel. All turn signal lights will flash simultaneously.

- The hazard warning flasher operates regardless of whether your vehicle is running or not.
- The turn signals do not work when the hazard flasher is on.

IN CASE OF AN EMERGENCY WHILE DRIVING

If the engine stalls while driving

- Reduce your speed gradually, keeping a straight line. Move cautiously off the road to a safe place.
- Turn on your hazard warning flasher.
- Try to start the engine again. If your vehicle will not start, we recommend that you contact an authorized HYUNDAI dealer or seek other qualified assistance.

If the engine stalls at a crossroad or crossing

If the engine stalls at a crossroads or crossing, if safe to do so, shift the gear to N (Neutral) and then push the vehicle to a safe location.

If you have a flat tire while driving

If a tire goes flat while you are driving:

- Take your foot off the accelerator pedal and let the vehicle slow down while driving straight ahead. Do not apply the brakes immediately or attempt to pull off the road as this may cause loss of vehicle control resulting in an accident. When the vehicle has slowed to such a speed that it is safe to do so, brake carefully and pull off the road. Drive off the road as far as possible and park on firm, level ground. If you are on a divided highway, do not park in the median area between the two traffic lanes.
- When the vehicle is stopped, press the hazard warning flasher button, shift the gear to P (Park, for automatic transmission vehicle) or neutral, apply the parking brake, and place ignition key or Engine start/stop button in LOCK/OFF position.
- Have all passengers get out of the vehicle. Be sure they all get out on the side of the vehicle that is away from traffic.
- When changing a flat tire, follow the instructions provided later in this chapter.

IF THE ENGINE WILL NOT START

- Be sure to shift the gear to N (Neutral) or P (Park) if it is an automatic transmission vehicle. The engine starts only when the gear is in N (Neutral) or P (Park).
- Turn on the interior light. If the light dims or goes out when you operate the starter, the battery is drained.
See instructions for “Jump Starting” provided in this chapter.
- Check the fuel level and add fuel if necessary.

If the vehicle still does not start, we recommend that you call an authorized HYUNDAI dealer for assistance.

NOTICE

Push or pull starting the vehicle may cause the catalytic converter to overload which can lead to damage to the emission control system.

JUMP STARTING

Jump starting can be dangerous if done incorrectly. Follow the jump starting procedure in this section to avoid serious injury or damage to your vehicle. If in doubt about how to properly jump start your vehicle, we strongly recommend that you have a service technician or towing service do it for you.

WARNING

To prevent **SERIOUS INJURY** or **DEATH** to you or bystanders, always follow these precautions when working near or handling the battery:



Always read and follow instructions carefully when handling a battery.



Wear eye protection designed to protect the eyes from acid splashes.



Keep all flames, sparks, or smoking materials away from the battery.



Hydrogen is always present in battery cells, is highly combustible, and may explode if ignited.



Keep batteries out of reach of children.



Batteries contain sulfuric acid which is highly corrosive. Do not allow acid to contact your eyes, skin or clothing.

If acid gets into your eyes, flush your eyes with clean water for at least 15 minutes and get immediate medical attention. If acid gets on your skin, thoroughly wash the area. If you feel pain or a burning sensation, get medical attention immediately.

- When lifting a plastic-cased battery, excessive pressure on the case may cause battery acid to leak. Lift with a battery carrier or with your hands on opposite corners.
- Do not attempt to jump start your vehicle if your battery is frozen.
- NEVER attempt to recharge the battery when the vehicle's battery cables are connected to the battery.
- The electrical ignition system works with high voltage.

NEVER touch these components with the engine running or when the ignition key or Engine start/stop button is in the ON position.

Jump starting procedure

1. Position the vehicles close enough that the jumper cables will reach, but do not allow the vehicles to touch.
2. Avoid fans or any moving parts in the engine compartment at all times, even when the vehicles are turned off.
3. Turn off all electrical devices such as radios, lights, air conditioning, etc. Put the vehicles in P (Park, for automatic transmission vehicle) or neutral, and set the parking brake. Turn both vehicles OFF.
4. Open the engine hood.



CAUTION

Before jump starting, make sure to correctly identify the positive (+) and negative (-) terminals to avoid reverse polarity connections.



5. Connect the jumper cables in the exact sequence shown in the illustration. First connect one jumper cable to the red, positive (+) jumper terminal of your vehicle (1).
6. Connect the other end of the jumper cable to the red, positive (+) battery/ jumper terminal of the assisting vehicle (2).
7. Connect the second jumper cable to the black, negative (-) battery/ jumper terminal of the assisting vehicle (3).
8. Connect the other end of the second jumper cable to the black, negative (-) chassis ground of your vehicle (4).

Do not allow the jumper cables to contact anything except the correct battery or jumper terminals or the correct ground. Do not lean over the battery when making connections.



WARNING

Do not connect the jumper cable to the negative (-) jumper terminal of the discharged battery. A spark could cause the battery to explode and lead to a personal injury or vehicle damage.

9. Start the engine of the assisting vehicle and let it run at approximately 2,000 RPM for a few minutes. Then start your vehicle.
10. Keep your vehicle operating for at least 30 minutes at idle or driving to assure your battery receives enough charge to be able to start on its own after the vehicle is shut off. A completely discharged battery may require as long as 60 minutes runtime to fully recharge it. If the vehicle is run for less, the vehicle may not restart.

If your vehicle will not start after a few attempts, it probably requires service. In this event please seek qualified assistance. If the cause of your battery discharging is not apparent, we recommend that you have your vehicle checked by an authorized HYUNDAI dealer.

Disconnect the jumper cables in the exact reverse order you connected them:

1. Disconnect the jumper cable from the black, negative (-) chassis ground of your vehicle (4).
2. Disconnect the other end of the jumper cable from the black, negative (-) battery/chassis ground of the assisting vehicle (3).
3. Disconnect the second jumper cable from the red, positive (+) battery/jumper terminal of the assisting vehicle (2).
4. Disconnect the other end of the jumper cable from the red, positive (+) jumper terminal of your vehicle (1).



Information



An inappropriately disposed battery can be harmful to the environment and human health. Dispose of the battery according to your local law(s) or regulations.

NOTICE

To prevent damage to your vehicle:

- Only use a 12-volt power supply (battery or jumper system) to jump start your vehicle.
- Do not attempt to jump start your vehicle by push-starting.



WARNING

While jump starting your vehicle, avoid the positive (+) and negative (-) cables to come in contact. A spark could cause personal injury.

IF THE ENGINE OVERHEATS

If your temperature gauge indicates overheating, you experience a loss of power, or hear a loud pinging or knocking, the engine will probably be too hot.

If this happens, you should :

1. Pull off the road and stop as soon as it is safe to do so.
2. Shift the gear to P (Park, for automatic transmission) or neutral and set the parking brake.
3. If the air conditioning is on, turn it off.
4. If engine coolant is running out under the vehicle or steam is coming out from underneath the hood, stop the engine. Do not open the hood until the coolant has stopped running or the steaming has stopped.
5. If there is no visible loss of engine coolant and no steam, leave the engine running and check to be sure the engine cooling fan is operating.
 - 1) If the fan is not running, turn the engine off.
6. Check to see if the water pump drive belt is missing.
 - 1) If it is not missing, check to see that it is tight.
 - 2) If the drive belt seems to be satisfactory, check for coolant leaking from the radiator, hoses or under the vehicle. (If the air conditioning had been in use, it is normal for cold water to be draining from it when you stop).



WARNING



While the engine is running, keep hands, clothing and tools away from the moving parts such as the cooling fan and drive belt to prevent serious injury.



7. If the water pump drive belt is broken or engine coolant is leaking out, stop the engine immediately and it is recommended to contact the nearest authorized HYUNDAI dealer for assistance.
8. If you cannot find the cause of the overheating, wait until the engine temperature has returned to normal. If coolant has been lost, carefully add coolant to the reservoir to bring the fluid level in the reservoir up to the halfway mark.
9. Proceed with caution, keeping alert for further signs of overheating. If overheating happens again, it is recommended to contact the nearest authorized HYUNDAI dealer for assistance.



WARNING



Never remove the engine coolant cap or the drain plug while the engine and radiator are hot.

Hot coolant and steam may blow out under pressure, causing serious injury.

Turn the engine off and wait until the engine cools down. Use extreme care when removing the coolant cap. Wrap a thick towel around it, and turn it counterclockwise slowly to the first stop. Step back while the pressure is released from the cooling system. When you are sure all the pressure has been released, press down on the cap, using a thick towel, and continue turning counterclockwise to remove it.



CAUTION

- Serious loss of coolant indicates a leak in the cooling system and we recommend the system be checked by an authorized HYUNDAI dealer.
- When the engine overheats from low engine coolant, suddenly adding engine coolant may cause cracks in the engine. To prevent damage, add engine coolant slowly in small quantities. It may require several refilling cycles to properly fill the engine cooling system. If necessary, we recommend that you consult to an authorized HYUNDAI dealer to perform this task.

TIRE PRESSURE MONITORING SYSTEM (TPMS)



- (1) Low Tire Pressure Telltale/TPMS Malfunction Indicator
- (2) Low Tire Pressure Position Telltale and Tire Pressure Telltale (Shown on the LCD display)

Check tire pressure



- You can check the tire pressure in the Warning mode on the cluster.
Refer to the “LCD Display Modes” in chapter 4.
- Tire pressure is displayed after a few minutes of driving after initial engine start up.
- If tire pressure is not displayed when the vehicle is stopped, “Drive to display” message will appear. After driving, check the tire pressure.
- The displayed tire pressure values may differ from those measured with a tire pressure gauge.
- You can change the tire pressure unit in the User Settings mode on the instrument cluster.
 - psi, kpa, bar (**Refer to “LCD Modes” in chapter 4**).

Tire pressure monitoring system



WARNING

Over-inflation or under-inflation can reduce tire life, adversely affect vehicle handling, and lead to sudden tire failure that may cause loss of vehicle control resulting in an accident.

Each tire, including the spare (if provided), should be checked monthly when cold and inflated to the inflation pressure recommended by the vehicle manufacturer on the vehicle placard or tire inflation pressure label. (If your vehicle has tires of a different size than the size indicated on the vehicle placard or tire inflation pressure label, you should determine the proper tire inflation pressure for those tires.)

As an added safety feature, your vehicle has been equipped with a tire pressure monitoring system (TPMS) that illuminates a low tire pressure telltale when one or more of your tires is significantly under-inflated. Accordingly, when the low tire pressure telltale illuminates, you should stop and check your tires as soon as possible, and inflate them to the proper pressure. Driving on a significantly under-inflated tire causes the tire to overheat and can lead to tire failure.

Under-inflation also reduces fuel efficiency and tire tread life, and may affect the vehicle's handling and stopping ability.

Please note that the TPMS is not a substitute for proper tire maintenance, and it is the driver's responsibility to maintain correct tire pressure, even if under-inflation has not reached the level to trigger illumination of the TPMS low tire pressure telltale.

Your vehicle has also been equipped with a TPMS malfunction indicator to indicate when the system is not operating properly. The TPMS malfunction indicator is combined with the low tire pressure telltale. When the system detects a malfunction, the telltale will flash for approximately one minute and then remain continuously illuminated. This sequence will continue upon subsequent vehicle start-ups as long as the malfunction exists.

When the malfunction indicator is illuminated, the system may not be able to detect or signal low tire pressure as intended. TPMS malfunctions may occur for a variety of reasons, including the installation of replacement or alternate tires or wheels on the vehicle that prevent the TPMS from functioning properly.

Always check the TPMS malfunction telltale after replacing one or more tires or wheels on your vehicle to ensure that the replacement or alternate tires and wheels allow the TPMS to continue to function properly.

NOTICE

If any of the below happens, we recommend that you have the system checked by an authorized HYUNDAI dealer.

- 1. The Low Tire Pressure Telltale/ TPMS Malfunction Indicator does not illuminate for 3 seconds when the ignition key or Engine start/stop button is pressed to the ON position or when the engine is running.**
- 2. The TPMS Malfunction Indicator remains illuminated after blinking for approximately 1 minute.**
- 3. The Low Tire Pressure Position Telltale remains illuminated.**

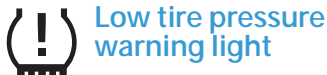

Low tire pressure warning light

Low tire pressure position and tire pressure telltale



When the tire pressure monitoring system warning indicators are illuminated and a warning message displayed on the cluster LCD display, one or more of your tires is significantly under-inflated. The Low Tire Pressure Position Telltale will indicate which tire is significantly underinflated by illuminating the corresponding position light.

If either telltale illuminates, immediately reduce your speed, avoid hard cornering and anticipate increased stopping distances. You should stop and check your tires as soon as possible. Inflate the tires to the proper pressure as indicated on the vehicle's placard or tire inflation pressure label located on the driver's side center pillar outer panel.

If you cannot reach a service station or if the tire cannot hold the newly added air, replace the low pressure tire with the spare tire.

The Low Tire Pressure Telltale will remain on and the TPMS Malfunction Indicator may blink for one minute and then remain illuminated (when the vehicle is driven approximately 10 minutes at speed above 25 km/h (15.5 mph)) until you have the low pressure tire repaired and replaced on the vehicle.



CAUTION

In winter or cold weather, the Low Tire Pressure Telltale may be illuminated if the tire pressure was adjusted to the recommended tire inflation pressure in warm weather. It does not mean your TPMS is malfunctioning because the decreased temperature leads to a proportional lowering of tire pressure.

When you drive your vehicle from a warm area to a cold area or from a cold area to a warm area, or the outside temperature is greatly higher or lower, you should check the tire inflation pressure and adjust the tires to the recommended tire inflation pressure.



WARNING

Low pressure damage

Significantly low tire pressure makes the vehicle unstable and can contribute to loss of vehicle control and increased braking distances.

Continued driving on low pressure tires can cause the tires to overheat and fail.



TPMS (Tire Pressure Monitoring System) malfunction indicator

The TPMS Malfunction Indicator will illuminate after it blinks for approximately one minute when there is a problem with the Tire Pressure Monitoring System.

We recommend that you have the system checked by an authorized HYUNDAI dealer as soon as possible.

NOTICE

If there is a malfunction with the TPMS, the Low Tire Pressure Position Telltale will not be displayed even though the vehicle has an under-inflated tire.

NOTICE

The TPMS Malfunction Indicator may illuminate after blinking for one minute if the vehicle is near electric power supply cables or radio transmitters such as police stations, government and public offices, broadcasting stations, military installations, airports, transmitting towers, etc.

Additionally, the TPMS Malfunction Indicator may illuminate if snow chains are used or electronic devices such as computers, chargers, remote starters, navigation, etc. This may interfere with normal operation of the TPMS.

Changing a tire with TPMS

If you have a flat tire, the Low Tire Pressure and Position telltales will come on. We recommend that you have the flat tire repaired by an authorized HYUNDAI dealer as soon as possible or replace the flat tire with the spare tire.

NOTICE

It is recommended that you do not use a puncture-repairing agent not approved by HYUNDAI dealer or the equivalent specified for your vehicle to repair and/or inflate a low pressure tire. Tire sealant not approved by HYUNDAI dealer or the equivalent specified for your vehicle may damage the tire pressure sensor.

The spare tire (if equipped) does not come with a tire pressure monitoring sensor. When the low pressure tire or the flat tire is replaced with the spare tire, the Low Tire Pressure Telltale will remain on. Also, the TPMS Malfunction Indicator will illuminate after blinking for one minute if the vehicle is driven at speed above 25 km/h (15.5 mph) for approximately 10 minutes.

Once the original wheel equipped with a tire pressure monitoring sensor is reinflated to the recommended pressure and reinstalled on the vehicle, the Low Tire Pressure Telltale and TPMS Malfunction Indicator will go off within a few minutes of driving.

If the indicators do not extinguish after a few minutes, it is recommended to contact the nearest authorized HYUNDAI dealer.

Each wheel is equipped with a tire pressure sensor mounted inside the tire behind the valve stem (except for the spare tire). You must use TPMS specific wheels. It is recommended that you always have your tires serviced by an authorized HYUNDAI dealer.

You may not be able to identify a tire with low pressure by simply looking at it. Always use a good quality tire pressure gauge to measure. Please note that a tire that is hot (from being driven) will have a higher pressure measurement than a tire that is cold.

A cold tire means the vehicle has been sitting for 3 hours and driven for less than 1.6 km (1 mile) in that 3 hour period.

Allow the tire to cool before measuring the inflation pressure. Always be sure the tire is cold before inflating to the recommended pressure.



WARNING

- The TPMS cannot alert you to severe and sudden tire damage caused by external factors such as nails or road debris.
- If you feel any vehicle instability, immediately take your foot off the accelerator, apply the brakes gradually with light force, and slowly move to a safe position off the road.



WARNING

Tampering with, modifying, or disabling the Tire Pressure Monitoring System (TPMS) components may interfere with the system's ability to warn the driver of low tire pressure conditions and/or TPMS malfunctions. Tampering with, modifying, or disabling the Tire Pressure Monitoring System (TPMS) components may void the warranty for that portion of the vehicle.



WARNING

- Do not modify the vehicle; it may interfere with the TPMS function.
- The wheels on the market do not have a TPMS sensor.
For your safety, we recommend that you use parts for replacement from an authorized HYUNDAI dealer.
- If you use the wheels on the market, use a TPMS sensor approved by a HYUNDAI dealer or the equivalent approved for your vehicle. If your vehicle is not equipped with a TPMS sensor or TPMS does not work properly, you may fail the periodic vehicle inspection conducted in your country.

IF YOU HAVE A FLAT TIRE (WITH SPARE TIRE, IF EQUIPPED)

WARNING

Changing a tire can be dangerous. Follow the instructions in this section when changing a tire to reduce the risk of serious injury or death.

CAUTION

Be careful as you use the jack handle to stay clear of the flat end. The flat end has sharp edges that could cause cuts.

Jack and tools



- (1) Jack handle
- (2) Jack
- (3) Wheel nut wrench

The jack, jack handle, and wheel nut wrench are stored in the luggage compartment under the luggage board.

The jack is provided for emergency tire changing only.



Turn the winged hold down bolt counterclockwise to remove the spare tire.

Store the spare tire in the same compartment by turning the winged hold down bolt clockwise.

To prevent the spare tire and tools from "rattling", store them in their proper location.



If it is hard to loosen the tire hold down wing bolt by hand, you can loosen it easily using the jack handle.

1. Put the jack handle (1) inside of the tire hold-down wing bolt.
2. Turn the tire hold-down wing bolt counterclockwise with the jack handle.

Changing tires

WARNING

A vehicle can slip or roll off of a jack causing serious injury or death to you or those nearby. Take the following safety precautions:

- Do not get under a vehicle that is supported by a jack.
- NEVER attempt to change a tire in the lane of traffic. ALWAYS move the vehicle completely off the road on level, firm ground away from traffic before trying to change a tire. If you cannot find a level, firm place off the road, call a towing service for assistance.
- Be sure to use the jack provided with the vehicle.
- ALWAYS place the jack on the designated jacking positions on the vehicle and NEVER on the bumpers or any other part of the vehicle for jacking support.
- Do not start or run the engine while the vehicle is on the jack.
- Do not allow anyone to remain in the vehicle while it is on the jack.
- Keep children away from the road and the vehicle.

Follow these steps to change your vehicle's tire:

1. Park on a level, firm surface.
2. Shift the gear to P (Park, for automatic transmission) or neutral apply the parking brake, and place the ignition key or Engine start/stop button in LOCK/OFF position.
3. Press the hazard warning flasher button.
4. Remove the wheel lug wrench, jack, jack handle, and spare tire from the vehicle.



[A] : Block

5. Block both the front and rear of the tire diagonally opposite of the tire you are changing.



6. Loosen the wheel nuts counterclockwise one turn each in the order shown above, but do not remove any wheel nuts until the tire has been raised off of the ground.



7. Place the jack at the designated jacking position under the frame closest to the tire you are changing. The jacking positions are plates welded to the frame with two notches. Never jack at any other position or part of the vehicle. Doing so may damage the side seal molding or other parts of the vehicle.



8. Insert the jack handle into the jack and turn it clockwise, raising the vehicle until the tire clears the ground. Make sure the vehicle is stable on the jack.
9. Loosen the lug nuts with the wheel lug nut wrench and remove them with your fingers. Remove the wheel from the studs and lay it flat on the ground out of the way. Remove any dirt or debris from the studs, mounting surfaces, and wheel.

WARNING

Wheels may have sharp edges. Handle them carefully to avoid possible severe injury. Before putting the wheel into place, be sure that there is nothing on the hub or wheel (such as mud, tar, gravel, etc.) that interferes with the wheel from fitting solidly against the hub.

If there is, remove it. If there is not good contact on the mounting surface between the wheel and hub, the wheel nuts could come loose and cause the loss of a wheel. Loss of a wheel may result in loss of control of the vehicle. This may cause serious injury or death.

10. Install the spare tire onto the studs of the hub.
11. Tighten the lug nuts with your fingers onto the studs with the smaller end of the lug nuts closest to the wheel.
12. Lower the vehicle to the ground by turning the jack handle counterclockwise.



13. Use the wheel lug nut wrench to tighten the lug nuts in the order shown. Double-check each lug nut until they are tight. After changing tires, we recommend that an authorized HYUNDAI dealer tighten the lug nuts to their proper torque as soon as possible. **The wheel lug nut should be tightened to 11~13 kgf·m (79~94 lbf·ft).**

If you have a tire gauge, check the tire pressure (see “Tires and Wheels” section in chapter 2 for tire pressure instructions.). If the pressure is lower or higher than recommended, drive slowly to the nearest service station and adjust it to the recommended pressure. Always reinstall the valve cap after checking or adjusting tire pressure. If the cap is not replaced, air may leak from the tire. If you lose a valve cap, buy another and install it as soon as possible. After changing tires, secure the flat tire and return the jack and tools to their proper storage locations.

NOTICE

Check the tire pressure as soon as possible after installing a spare tire. Adjust it to the recommended pressure.

CAUTION

Your vehicle has metric threads on the studs and wheel nuts. Make certain during tire changing that the same nuts that were removed are reinstalled. If you have to replace your wheel bolts make sure they have metric threads to avoid damaging the studs and ensure the wheel is properly secured to the hub. We recommend that you consult an authorized HYUNDAI dealer for assistance.

WARNING

Wheel studs

If the studs are damaged, they may lose their ability to retain the wheel. This could lead to the loss of the wheel and a collision resulting in serious injuries.

If any of the equipment such as the jack, wheel nuts, studs, or other equipment is damaged or in poor condition, do not attempt to change the tire and call for assistance.

Use of compact spare tires (if equipped)

Compact spare tires are designed for emergency use only. Drive carefully on the compact spare tire and always follow the safety precautions.



WARNING

To prevent compact spare tire failure and loss of control possibly resulting in an accident:

- Use the compact spare tire only in an emergency.
- NEVER operate your vehicle over 80 km/h (50 mph).
- Do not exceed the vehicle's maximum load rating or the load carrying capacity shown on the sidewall of the compact spare tire.
- Do not use the compact spare tire continuously. Repair or replace the original tire as soon as possible to avoid failure of the compact spare tire.

When driving with the compact spare tire mounted to your vehicle:

- Check the tire pressure after installing the compact spare tire. The compact spare tire should be inflated to 420 kPa (60 psi).
- Do not take this vehicle through an automatic car wash while the compact spare tire is installed.
- Do not use the compact spare tire on any other vehicle because this tire has been designed especially for your vehicle.
- The compact spare tire's tread life is shorter than a regular tire. Inspect your compact spare tire regularly and replace worn compact spare tires with the same size and design, mounted on the same wheel.
- Do not use more than one compact spare tire at a time.
- Do not tow a trailer while the compact spare tire is installed.

i Information

When the original tire and wheel are repaired and reinstalled on the vehicle, the wheel nuts torque must be set correctly. The correct wheel nut tightening torque is 11~13 kgf.m (79~94 lbf.ft).

NOTICE

To prevent damaging the compact spare tire and your vehicle:

- Drive slowly enough for the road conditions to avoid all hazards, such as a potholes or debris.
- Avoid driving over obstacles. The compact spare tire diameter is smaller than the diameter of a conventional tire and reduces the ground clearance approximately 25 mm (1 inch).
- Do not use tire chains on the compact spare tire. Because of the smaller size, a tire chain will not fit properly.
- Do not use the compact spare tire on any other wheels, nor should standard tires, snow tires, wheel covers or trim rings be used with the compact spare wheel.
- Do not suddenly accelerate or decelerate (0 ↔ 40 km/h) (0 ↔ 25 mph) in any driving mode. It may cause leakage of transfer oil.

Jack label

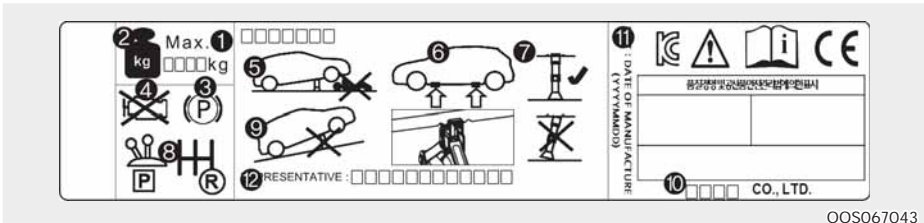



OOS067043

The actual Jack label in the vehicle may differ from the illustration.

For more detailed specifications, refer to the label attached to the jack.

1. Model Name
2. Maximum allowable load
3. When using the jack, set your parking brake.
4. When using the jack, stop the engine.
5. Do not get under a vehicle that is supported by a jack.
6. The designated locations under the frame
7. When supporting the vehicle, the base plate of jack must be vertical under the lifting point.
8. Shift the gear to the P position on with automatic transmission.
9. The jack should be used on firm level ground.
10. Jack manufacture
11. Production date
12. Representative company and address

EC declaration of conformity for jack

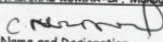
 MK TRON AUTOPARTS PRIVATE LIMITED (Formerly known as UMW Dongshin Motech Private Limited)		
		
13.04.2022		
EC DECLARATION OF CONFORMITY		
According to EC Machinery directive 2006/42/EC		
Here with declare that the following products is in conformity with the provision of following EC Directive[s] he undersigned representing the manufacturer.		
Manufacturer Name: M/s. MKTRON AUTO PARTS PRIVATE LIMITED.		
Address	: 14 & 133, SIDCO IND.ESTATE, THIRUMAZHISAI, CHENNAI-600 124. TAMIL NADU, INDIA	
Declare under our sole responsibilities that the products.		
Products	: jack Assemblies - Pantograph & Bottle Jacks	
Type Designation[s]	: 700 KG, 800 KG, 1000 KG & 2000 KG	
Serial no	: NA [proto type]	
Year of manufacture: 2021		
In which the declaration reacts is in conformity with the following standards or other normative documents		
EN -ISO12100 [2010]	Safety of machinery-General principles for design- risk assessment and risk reduction	
EN ISO12100-2/A1 [2009]	Safety of machinery -Basic concepts, general principles design part Part-2 Technical principles	
EN149A/A1 [2008]	Mobile or movables jacks and associated lifting equipment	
Following the provisions of Directives:		
2006/42/EC	Directive on the approximation of the laws of member states relating to machinery Directive [OJL157 Jun, 2006]	
<u>MKTRON AUTO PARTS PVT.LTD, INDIA /02.09.2021. C.NIRMAL KUMAR-Sr. Manager - Operation</u>		
Name & Place of	 Name and Designation	
<ul style="list-style-type: none"> • T.C.F Compiling Person: QS Zurich AG • P.O Box No: 6335 CH: 8050 Zurich 		
STAMPING DIVISION Plot No. A-19, Telegaon Industrial Area, Village Navlakumbre, Taluk Meval, Pune - 410 507, Maharashtra, INDIA. Tel. No. : +91-2114-306000	JACK DIVISION No. 14, SIDCO Industrial Estate, Thirumazhisai, Chennai - 600124, Tamil Nadu, INDIA Tel. No. +91-44-26810211	DIE CASTING DIVISION 824 & B. 160, SIDCO Industrial Estate, Thirumudikkam, Chennai - 600 132, Tamilnadu, INDIA. Tel. No. +91-44-4904 7777
CIN NO. : U29255PN2007PTC133046		
Registered Office: Plot No. A-19, Telegaon Industrial Area, Village Navlakumbre, Tal. Meval, Pune - 410 507. Maharashtra. INDIA.		

NX4I082001

IF YOU HAVE A FLAT TIRE (WITH TIRE MOBILITY KIT, IF EQUIPPED)



For safe operation, carefully read and follow the instructions in this manual before use.

- (1) Compressor
- (2) Sealant bottle

The Tire Mobility Kit is a temporary fix to the tire and the tire should be inspected by an authorized HYUNDAI dealer as soon as possible.

CAUTION

When two or more tires are flat, do not use the tire mobility kit because the supported one sealant of Tire Mobility Kit is only used for one flat tire.

WARNING

Do not use the Tire Mobility Kit to repair punctures in the tire walls. This can result in an accident due to tire failure.

WARNING

Have your tire repaired as soon as possible. The tire may lose air pressure at any time after inflating with the Tire Mobility Kit.

Introduction

With the Tire Mobility Kit you stay mobile even after experiencing a tire puncture.

The compressor and sealing compound system effectively and comfortably seals most punctures in a passenger car tire caused by nails or similar objects and reinflates the tire.

After you ensure that the tire is properly sealed you can drive cautiously on the tire (distance up to 200 km (120 miles)) at a max. speed of (80 km/h (50 mph)) in order to reach a service station or tire dealer for the tire replacement.

It is possible that some tires, especially with larger punctures or damage to the sidewall, cannot be sealed completely.

Air pressure loss in the tire may adversely affect tire performance.

For this reason, you should avoid abrupt steering or other driving maneuvers, especially if the vehicle is heavily loaded or if a trailer is in use.

The Tire Mobility Kit is not designed or intended as a permanent tire repair method and is to be used for one tire only.

This instruction shows you step by step how to temporarily seal the puncture simply and reliably.

Read the section “Notes on the safe use of the Tire Mobility Kit”.



WARNING

Do not use the TMK if a tire is severely damaged by driving run flat or with insufficient air pressure.

Only punctured areas located within the tread region of the tire can be sealed using the TMK.

Notes on the safe use of the Tire Mobility Kit

- Park your car at the side of the road so that you can work with the Tire Mobility Kit away from moving traffic.
- To be sure your vehicle will not move, even when you're on fairly level ground, always set your parking brake.
- Only use the Tire Mobility Kit for sealing/inflation passenger car tires. Only punctured areas located within the tread region of the tire can be sealed using the tire mobility kit.
- Do not use on motorcycles, bicycles or any other type of tires.
- When the tire and wheel are damaged, do not use Tire Mobility Kit for your safety.
- Use of the Tire Mobility Kit may not be effective for tire damage larger than approximately 4 mm (1/16 inch). Please contact the nearest HYUNDAI dealer if the tire cannot be made roadworthy with the Tire Mobility Kit.
- Do not use the Tire Mobility Kit if a tire is severely damaged by driving run flat or with insufficient air pressure.
- Do not remove any foreign objects such as nails or screws that have penetrated the tire.
- Provided the car is outdoors, leave the engine running. Otherwise operating the compressor may eventually drain the car battery.
- Never leave the Tire Mobility Kit unattended while it is being used.
- Do not leave the compressor running for more than 10 minutes at a time or it may overheat.
- Do not use the Tire Mobility Kit if the ambient temperature is below -30°C (-22°F).
- In case of skin contact with the sealant, wash the area thoroughly with plenty of water. If the irritation persists, seek medical attention.
- In case of eye contact with the sealant, flush your eyes for at least 15 minutes. If the irritation persists, seek medical attention.
- In case of swallowing the sealant, rinse the mouth and drink plenty of water. However, never give anything to an unconscious person and seek medical attention immediately.
- Long time exposure to the sealant may cause damage to bodily tissue such as kidney, etc.

Components of the Tire Mobility Kit

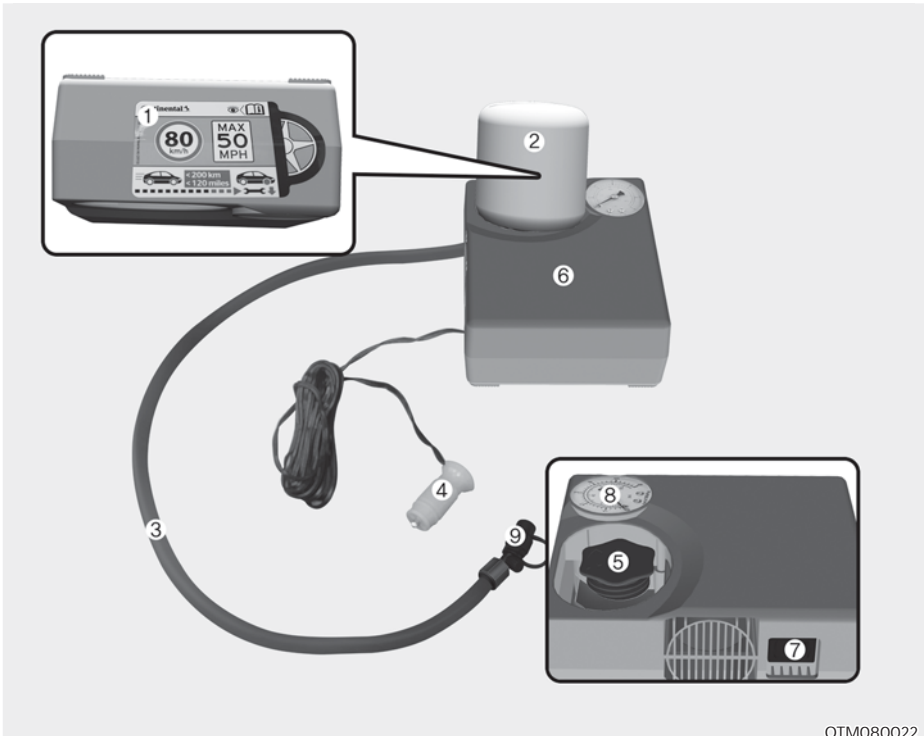

OTM080022

1. Speed restriction label
2. Sealant and sealant bottle
3. Connection hose of compressor and tire
4. Connector and cable for connection of power outlet
5. Holder for the sealant bottle
6. Compressor
7. ON/OFF switch
8. Pressure gauge for displaying the tire inflation pressure
9. Valve for reducing tire inflation pressure

Connectors, cable and connection hose are stored in the compressor housing.

Strictly follow the specified sequence, otherwise the sealant may escape under high pressure.

⚠️ WARNING

Do not use the tire sealant after the sealant has expired (i.e. past the expiration date on the sealant container). This can increase the risk of tire failure.

⚠️ WARNING

- Keep out of reach of children.
- Avoid contact with eyes.
- Do not swallow.

Using the Tire Mobility Kit**⚠️ WARNING**

Detach the speed restriction label (1) from the sealant bottle (2), and place it in a highly visible place inside the vehicle such as on the steering wheel to remind the driver not to drive too fast.



1. Shake the sealant bottle (2).



OTM080023

2. Remove the cover (A) of the sealant bottle (2) and compressor (6).



OTM080024

3. Connect the sealant bottle (2) and compressor (6).
4. Make sure that the valve (9) for reducing tire inflation pressure is closed.



ONX4080011

5. Unscrew the valve cap from the valve of the defective and screw the connection hose (3) of the compressor and tire.

NOTICE

Securely install the sealant filling hose to the valve. If not, sealant may flow backward, possibly clogging the filling hose.

6. Make sure the compressor turns off by pressing [O] of the main switch (7).



ONX41082004

7. Connect the cable and connector (4) to the power outlet in the vehicle.
8. Start the vehicle.

9. With the engine running, switch on the compressor by pressing [!] and let it run for approximately 5–7 minutes to fill the sealant up to proper pressure. (Refer to “Tire and Wheels” section in chapter 2). The inflation pressure of the tire after filling is unimportant and will be checked/ corrected later.

Be careful not to overinflate the tire and stay away from the tire when filling it.



CAUTION

Do not attempt to drive your vehicle if the tire pressure is below 200 kpa (29 psi). This could result in an accident due to sudden tire failure.

10. Switch off the compressor.
11. Detach the hoses from the sealant bottle connector and from the tire valve.

Return the Tire Mobility Kit to its storage location in the vehicle.



WARNING

Do not leave your vehicle running in a poorly ventilated area for extended periods of time. Carbon monoxide poisoning and suffocation can occur.

Distributing the sealant

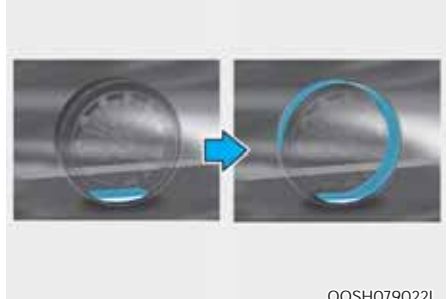

OOSH079022L

12. Immediately drive approximately 7–10 km (4–6 miles or about 10 minutes) to evenly distribute the sealant in the tire.

Do not exceed a speed of 80 km/h (50 mph). If possible, do not fall below a speed of 20 km/h (12 mph).

While driving, if you experience any unusual vibration, ride disturbance or noise, reduce your speed and drive with caution until you can safely pull off of the side of the road.

Call for road side service or towing.

13. After driving approximately 7~10 km (4~6 miles or about 10 minutes), stop at a safe location.



14. Connect the connection hose (3) of the compressor and tire into the tire valve.
15. Connect cables (4) to the battery.
16. Adjust the tire inflation pressure to the recommended tire inflation.

With the engine running, proceed as follows.

- **To increase the inflation pressure:**
Switch on the compressor.
To check the current inflation pressure setting, briefly switch off the compressor.
- **To reduce the inflation pressure:**
Adjust the valve (9) for reducing tire inflation pressure.

NOTICE

Do not let the compressor run for more than 10 minutes, otherwise the device will overheat and may be damaged.

Checking the tire inflation pressure

1. After driving approximately 7~10 km (4~6 miles or about 10 minutes), stop at a safe location.



2. Connect the connection hose (3) of the compressor and tire into the tire valve.
3. Connect cables (4) to the battery.
4. Adjust the tire inflation pressure to the recommended tire inflation.

With the engine running, proceed as follows.

- **To increase the inflation pressure:**
Switch on the compressor.
To check the current inflation pressure setting, briefly switch off the compressor.
- **To reduce the inflation pressure:**
Adjust the valve (9) for reducing tire inflation pressure.

NOTICE

Do not let the compressor run for more than 10 minutes, otherwise the device will overheat and may be damaged.

 **Information**

The pressure gauge may show higher than actual reading when the compressor is running. To get an accurate tire pressure, the compressor needs to be turned off.

 **CAUTION**

If the inflation pressure is not maintained, drive the vehicle a second time, refer to Distributing the sealant. Then repeat steps 1 to 4.

Use of the TMK may be ineffectual for tire damage larger than approximately 4 mm (0.16 in).

We recommend that you contact an authorized HYUNDAI dealer if the tire cannot be made roadworthy with the Tire Mobility Kit.

 **WARNING**

The tire inflation pressure must be inflated to the proper pressure (Refer to "Tire and Wheels" section in chapter 2). If it is not, do not continue driving.

Call for road side service or towing.

 **CAUTION**

Tire pressure sensor

The sealant on the tire pressure sensor and wheel should be removed when you replace the tire with a new one and inspect the tire pressure sensors. We recommend that you get this done at an authorized dealer.

 **Information**

When reinstalling the repaired or replaced tire and wheel on the vehicle, tighten the wheel bolt to 11~13 kgf·m (79~94 lbf·ft).

TOWING

Towing service

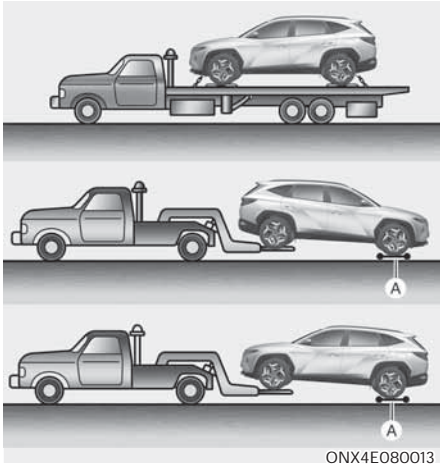

[A] : Dollies

If emergency towing is necessary, we recommend having it done by an authorized HYUNDAI dealer or a commercial tow-truck service.

Proper lifting and towing procedures are necessary to prevent damage to the vehicle. The use of wheel dollies or flatbed is recommended.

For 2WD vehicles, it is acceptable to tow the vehicle with the rear wheels on the ground (without dollies) and the front wheels off the ground.

If any of the loaded wheels or suspension components are damaged or the vehicle is being towed with the front wheels on the ground, use a towing dolly under the front wheels.

When being towed by a commercial tow truck and wheel dollies are not used, the front of the vehicle should always be lifted, not the rear.

For 4WD vehicles, it must be towed with a wheel lift and dollies or flatbed equipment with all the wheels off the ground.

NOTICE

Do not lift the vehicle by the tow fitting or body and chassis parts. Otherwise the vehicle may be damaged.



CAUTION

- Do not tow the vehicle with the front wheels on the ground as this may cause damage to the vehicle.



- Do not tow with sling-type equipment. Use wheel lift or flatbed equipment.



When towing your vehicle in an emergency without wheel dollies:

- Vehicle without EPB
 1. Place the ignition switch in the ACC position.
 2. Place the gear in N (Neutral).
 3. Release the parking brake.
- Vehicle with EPB
 1. Release EPB before turning off the engine.
 2. Place the Engine Start/Stop button to the OFF position.
 3. Change the gear to N (Neutral) while pressing the brake pedal.
 4. Place the Engine Start/Stop button to the ACC position.



CAUTION

Failure to shift the gear to N (Neutral) may cause internal damage to the transmission.

Removable towing hook

1. Open the tailgate, and remove the towing hook from the tool case.



2. Remove the hole cover by pressing(A), or lifting(B) the lower part of the cover on the bumper.
3. Install the towing hook by turning it clockwise into the hole until it is fully secured.
4. Remove the towing hook and install the cover after use.

Emergency towing



If towing is necessary, we recommend you have it done by an authorized HYUNDAI dealer or a commercial tow truck service.

If a towing service is not available in an emergency, your vehicle may be temporarily towed using a cable or chain secured to the emergency towing hook at the front (or rear) of the vehicle.

Use extreme caution when towing the vehicle with a cable or chain. A driver must be in the vehicle to steer it and operate the brakes.

Towing in this manner may be done only on hard-surfaced roads for a short distance and at low speeds. Also, the wheels, axles, power train, steering and brakes must all be in good working condition.

CAUTION

The driver must be in the vehicle for steering and braking operations when the vehicle is being towed. Passengers other than the driver must not be in the vehicle.

Always follow these emergency towing precautions:

- Place the ignition key or Engine start/stop button in the ACC position so the steering wheel is not locked.
- Shift the gear to N (Neutral).
- Release the parking brake.
- Depress the brake pedal with more force than normal as you will have reduced braking performance.
- More steering effort will be required because the power steering system will be disabled.
- Use a vehicle heavier than your own to tow your vehicle.
- The drivers of both vehicles should communicate with each other frequently.
- Before emergency towing, check that the hook is not broken or damaged.
- Fasten the towing cable or chain securely to the hook.
- Do not jerk the hook. Apply steady and even force.

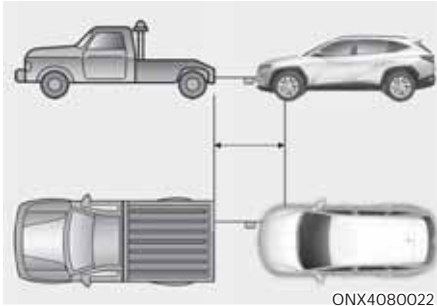

- Use a towing cable or chain less than 5 m (16 feet) long. Attach a white or red cloth (about 30 cm (12 inches) wide) in the middle of the cable or chain for easy visibility.
- Drive carefully so the towing cable or chain remains tight during towing.
- Before towing, check the automatic transmission for fluid leaks under your vehicle. If the automatic transmission fluid is leaking, flatbed equipment or a towing dolly must be used.

NOTICE

Accelerate or decelerate the vehicle in a slow and gradual manner while maintaining tension on the tow rope or chain to start or drive the vehicle, otherwise tow hooks and the vehicle may be damaged.

NOTICE

To avoid damage to your vehicle and vehicle components when towing:

- Always pull straight ahead when using the towing hooks. Do not pull from the side or at a vertical angle.
- Do not use the towing hooks to pull a vehicle out of mud, sand or other conditions from which the vehicle cannot be driven out under its own power.
- Limit the vehicle speed to 15 km/h (10 mph) and drive less than 1.5 Km (1 mile) when towing to avoid serious damage to transmission. (for Automatic transmission vehicle)
- The vehicle should be towed at a speed of 25 km/h (15 mph) or less within the distance of 20 km (12 miles).

EMERGENCY COMMODITY (IF EQUIPPED)

Your vehicle is equipped with emergency commodities to help you respond to emergency situation.

Fire extinguisher

If there is small fire and you know how to use the fire extinguisher, follow these steps carefully.

1. Pull out the safety pin at the top of the extinguisher that keeps the handle from being accidentally pressed.
2. Aim the nozzle towards the base of the fire.
3. Stand approximately 2.5 m (8 ft) away from the fire and squeeze the handle to discharge the extinguisher. If you release the handle, the discharge will stop.
4. Sweep the nozzle back and forth at the base of the fire. After the fire appears to be out, watch carefully since it may re-ignite.

First aid kit

Supplies for use in giving first aid such as scissors, bandage and adhesive tape, etc., are provided.

Triangle reflector

Place the triangle reflector on the road to warn oncoming vehicles during emergencies, such as when the vehicle is parked by the roadside due to problems.

Tire pressure gauge (if equipped)

Tires normally lose some air in day-to-day use, and you may have to add air periodically and usually it is not a sign of a leaking tire, but of normal wear. Always check tire pressure when the tires are cold because tire pressure increases with temperature.

To check the tire pressure, take the following steps:

1. Unscrew the inflation valve cap that is located on the rim of the tire.
2. Press and hold the gauge against the tire valve. Some air will leak as you begin and more will leak if you don't press the gauge in firmly.
3. A firm non-leaking push will activate the gauge.
4. Read the tire pressure on the gauge to see whether the tire pressure is low or high.
5. Adjust the tire pressure to the specified pressure. Refer to "Tires and Wheels" section in chapter 2.
6. Reinstall the inflation valve cap.

9. Maintenance

Engine compartment.....	9-3
Maintenance services.....	9-4
Owner's responsibility	9-4
Owner maintenance precautions.....	9-4
Owner maintenance	9-5
Owner maintenance schedule	9-6
Scheduled maintenance services.....	9-7
Normal Maintenance Schedule - Petrol Engine.....	9-8
Maintenance Under Severe Usage and Low Mileage Conditions - Petrol Engine	9-12
Normal Maintenance Schedule - Diesel Engine	9-13
Maintenance Under Severe Usage and Low Mileage Conditions - Diesel Engine	9-17
Explanation of scheduled maintenance items	9-19
Engine oil	9-22
Checking the engine oil level	9-22
Checking the engine oil and filter	9-25
Engine coolant	9-26
Checking the coolant level	9-26
Changing coolant	9-28
Brake/clutch fluid	9-29
Checking the brake/clutch fluid level	9-29
Washer fluid	9-30
Checking the washer fluid level	9-30
Fuel filter (for diesel engine)	9-30
Draining water from fuel filter	9-30
Fuel filter cartridge replacement	9-30
Air cleaner	9-31
Filter replacement	9-31
Cabin air filter	9-32
Filter inspection.....	9-32
Filter replacement.....	9-32
Wiper blades	9-33
Blade inspection.....	9-33
Blade replacement.....	9-33

Battery	9-38
For best battery service	9-39
Battery capacity label	9-40
Battery recharging	9-40
Reset items	9-41
Tires and wheels	9-42
Tire care	9-42
Recommended cold tire inflation pressures	9-42
Check tire inflation pressure	9-43
Tire rotation	9-44
Wheel alignment and tire balance	9-45
Tire replacement	9-45
Wheel replacement	9-46
Tire traction	9-46
Tire maintenance	9-46
Tire sidewall labeling	9-47
Low aspect ratio tires	9-50
Fuses	9-51
Instrument panel fuse replacement	9-52
Engine compartment panel fuse replacement	9-53
Fuse/relay panel description	9-54
Light bulbs	9-64
Headlamp, position lamp, turn signal lamp, Daytime Running Light (DRL) replacement	9-65
Headlamp aiming	9-68
Side repeater lamp replacement	9-71
Rear combination lamp replacement	9-71
High mounted stop lamp replacement	9-74
License plate lamp replacement	9-75
Interior light replacement	9-75
Appearance care	9-77
Exterior care	9-77
Interior care	9-83
Emission control system	9-86
Crankcase emission control system	9-86
Evaporative emission control system	9-86
Exhaust emission control system	9-87
Gasoline Particulate Filter (GPF)	9-88
Diesel Particulate Filter (DPF)	9-89
Lean NOx Trap (for diesel engine)	9-89
Selective Catalytic Reduction (SCR) (for diesel engine)	9-90

ENGINE COMPARTMENT

■ Petrol Engine (Smartstream G2.0)

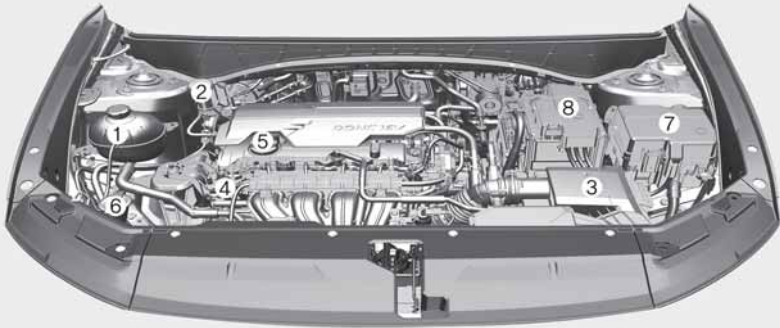

■ Diesel (Smartstream D2.0)



The actual engine compartment in the vehicle may differ from the illustration.

ONX4E090003R/ ONX4090002R

- | | |
|----------------------------------|--------------------------------------|
| 1. Engine coolant reservoir | 5. Engine oil filler cap |
| 2. Brake/clutch* fluid reservoir | 6. Windshield washer fluid reservoir |
| 3. Air cleaner | 7. Fuse box |
| 4. Engine oil dipstick | 8. Battery |

* : if equipped

MAINTENANCE SERVICES

You should exercise the utmost care to prevent damage to your vehicle and injury to yourself whenever performing any maintenance or inspection procedures.

We recommend you have your vehicle maintained and repaired by an authorized HYUNDAI dealer. An authorized HYUNDAI dealer meets HYUNDAI's high service quality standards and receives technical support from HYUNDAI in order to provide you with a high level of service satisfaction.

Owner's responsibility

Maintenance service and record retention are the owner's responsibility.

You should retain documents that show proper maintenance has been performed on your vehicle in accordance with the scheduled maintenance service charts shown on the following pages. You need this information to establish your compliance with the servicing and maintenance requirements of your vehicle warranties.

Detailed warranty information is provided in your Service Passport.

Repairs and adjustments required as a result of improper maintenance or a lack of required maintenance are not covered.

Owner maintenance precautions

Inadequate, incomplete or insufficient servicing may result in operational problems with your vehicle that could lead to vehicle damage, an accident, or personal injury. This chapter provides instructions only for the maintenance items that are easy to perform.

Your vehicle should not be modified in any way. Such modifications may adversely affect the performance, safety or durability of your vehicle and may, in addition, violate conditions of the limited warranties covering the vehicle.

NOTICE

Improper owner maintenance during the warranty period may affect warranty coverage. For details, read the separate Service Passport provided with the vehicle. If you're unsure about any servicing or maintenance procedure, we recommend that the system be serviced by an authorized HYUNDAI dealer.

OWNER MAINTENANCE



WARNING

Performing maintenance work on a vehicle can be dangerous. If you lack sufficient knowledge and experience or the proper tools and equipment to do the work, we recommend that having it done by an authorized HYUNDAI dealer. ALWAYS follow these precautions for performing maintenance work:

- Park your vehicle on level ground, shift the vehicle to P (Park, for automatic transmission) position or neutral (vehicle) position, apply the parking brake, and place the ignition switch or Engine Start/Stop button in the LOCK/ OFF position.
- Block the tires (front and back) to prevent the vehicle from moving. Remove loose clothing or jewelry that can become entangled in moving parts.
- If you must run the engine during maintenance, do so out doors or in an area with plenty of ventilation.
- Keep flames, sparks, or smoking materials away from the battery and fuel-related parts.



WARNING

Touching metal parts

Do not touch metal parts (including strut bars) while the engine is operating or hot. Doing so could result in serious personal injury. Turn the engine off and wait until the metal parts cool down to perform maintenance work on the vehicle.

The following lists are vehicle checks that we recommend to be performed by the owner or an authorized HYUNDAI dealer at the frequencies indicated to help ensure safe, dependable operation of your vehicle.

Any adverse conditions should be brought to the attention of your dealer as soon as possible.

These Owner Maintenance vehicle checks are generally not covered by warranties and you may be charged for labor, parts and lubricants used.



WARNING

Diesel Engine

Never manipulate or modify the injection system while running the diesel engine or within 30 seconds after turning OFF the diesel engine. The high-pressure pump, high-pressure pipes, rail, and injectors are still subject to high pressure immediately after stopping the diesel engine.

When the fuel leakage vents out, it may cause serious body injury. Any people, who are implanted with the artificial cardiac pacemaker, should remain away from the ECU or the wiring harness by at least 30 cm (12 inches), while running the diesel engine. The high currents of the electronic engine control system produce a considerable amount of magnetic fields.

Owner maintenance schedule

When you stop for fuel:

- Check the coolant level in the engine coolant reservoir or the water-cooled intercooler coolant reservoir.
- Check the windshield washer fluid level.
- Check for low or under-inflated tires.



WARNING

Be careful when checking your coolant level if the engine is hot. This may result in coolant being blown out of the opening and cause serious burns and other injuries.

While operating your vehicle:

- Note any changes in the sound of the exhaust or any smell of exhaust fumes in the vehicle.
- Check for vibrations in the steering wheel. Notice if there is any increased steering effort or looseness in the steering wheel, or change in its straight-ahead position.
- Notice if your vehicle constantly turns slightly or “pulls” to one side when traveling on smooth, level road.
- When stopping, listen and check for unusual sounds, pulling to one side, increased brake pedal travel or “hard-to-push” brake pedal.
- If any slipping or changes in the operation of your transmission occurs, check the transmission fluid level.
- Check the automatic transmission P (Park) function.
- Check the parking brake.
- Check for fluid leaks under your vehicle (water dripping from the air conditioning system during or after use is normal).

At least monthly:

- Check coolant level in the engine coolant reservoir.
- Check the operation of all exterior lights, including the stoplights, turn signals and hazard warning flashers.
- Check the inflation pressures of all tires including the spare for tires that are worn, show uneven wear, or are damaged.
- Check for loose wheel lug nuts.

At least twice a year: (for example, every Spring and Autumn)

- Check radiator, heater and air conditioning hoses for leaks or damage.
- Check windshield washer spray and wiper operation. Clean wiper blades with a clean cloth dampened with washer fluid.
- Check headlamp alignment.
- Check muffler, exhaust pipes, shields and clamps.
- Check the seat belts for wear and function.

At least once a year:

- Clean body and door drain holes.
- Lubricate door hinges and hood hinges.
- Lubricate door and hood locks and latches.
- Lubricate door rubber weather strips.
- Check the air conditioning system.
- Inspect and lubricate automatic transmission linkage and controls.
- Clean the battery and terminals.
- Check the brake fluid level.

SCHEDULED MAINTENANCE SERVICES

- *1: As it is normal for engine oil to be consumed during driving, the amount of engine oil should be checked regularly. Operating with an insufficient amount of oil can damage the engine, and such damage is not covered by warranty.
- *2: Check the engine oil level and leak every 500km(350miles) or before starting a long trip. As it is normal for engine oil to be consumed during driving, the engine oil level should be checked on regular basis. The engine oil change interval for normal operating conditions is based on the use of the recommended engine specification. If the recommended engine oil specification is not used, then replace the engine oil according to the maintenance schedule under severe operating conditions.
- *3: Inspect drive belt tensioner, idler and alternator pulley and if necessary correct or replace.
- *4: This maintenance schedule depends on fuel quality. It is applicable only when using a qualified fuel <"EN590 or equivalent">. If the diesel fuel specifications don't meet the EN590, it must be replaced according to the severe maintenance schedule. If there are some important safety matters like fuel flow restriction, surging, loss of power, hard starting problem etc., replace the fuel filter immediately regardless of maintenance schedule. We recommend that you consult an authorized HYUNDAI dealer for details.
- *5: For your convenience, it can be replaced prior to it's interval when you do maintenance of other items.
- *6: When adding coolant, use only deionized water or soft water for your vehicle and never mix hard water in the coolant filled at the factory. An improper coolant mixture can result in serious malfunction or engine damage.
- *7: For your convenience, it can be replaced prior to it's interval when you do maintenance of other items.
- *8: Transfer case oil and differential oil should be changed anytime they have been submerged in water.

NORMAL MAINTENANCE SCHEDULE - PETROL ENGINE

MAINTENANCE INTERVALS	Number of months or driving distance, whichever comes first									
	Kmsx1,000	10	20	30	40	50	60	70	80	
MAINTENANCE ITEM	Months	12	24	36	48	60	72	84	96	
MAINTENANCE ITEM	Years	1	2	3	4	5	6	7	8	
ENGINE BAY										
Engine oil & filter *1 *2		R	R	R	R	R	R	R	R	R
Drive belt *3		-	I	-	I	-	I	-	I	-
Air Cleaner Filter		C	C	R	C	C	R	C	C	C
Battery condition & specific gravity		I	I	I	I	I	I	I	I	I
Spark Plugs *5		Replace at every 160,000 kms								
Vaccum Hoses		I	I	I	I	I	I	I	I	I
Tensioner/idler/damper pulley		Inspect when replacing the drive belt or timing belt/chain								
Brake/Clutch fluid		Inspect at every service; Replace at every 40,000 Km or 36 months								
Engine Coolant (topup & specify gravity) *6		Inspect at every service; Replace first at 100,000 Km or 120 months ; then at every 40,000 Km or 24 months *7								
Automatic Transmission Fluid (if equipped)		No check ; No Service Required								

I : Inspect and if necessary adjust,top-up, clean or replace C : Clean and Replace if necessary

R : Replace

NORMAL MAINTENANCE SCHEDULE - PETROL ENGINE (CONT.)

MAINTENANCE INTERVALS	Number of months or driving distance, whichever comes first								
	Kmsx1,000	10	20	30	40	50	60	70	80
MAINTENANCE ITEM	Months	12	24	36	48	60	72	84	96
	Years	1	2	3	4	5	6	7	8
VEHICLE ON FLOOR									
Wiper (wiper blade, washer fluid)		I	I	I	I	I	I	I	I
Brake/Clutch (Pedal free play/Pipes/Hoses/Connectors)		I	I	I	I	I	I	I	I
Fuel filler cap		I	I	I	I	I	I	I	I
Climate control air filter		R	R	R	R	R	R	R	R
Check AC system (refrigerant/Compressor)		I	I	I	I	I	I	I	I
Cooling system (water pump, hoses) & leakage		I	I	I	I	I	I	I	I
VEHICLE ON LIFT									
Steering gear rack, linkage and boots		I	I	I	I	I	I	I	I
Exhaust system		I	I	I	I	I	I	I	I
Fuel filter *4		-	-	-	-	-	R	-	-
Fuel tank air filter (if equipped)		Replace at every 60,000 Kms or 48 Months							
Front & rear suspension (linkages & ball joints)		I	I	I	I	I	I	I	I

I : Inspect and if necessary adjust,top-up, clean or replace

C : Clean and Replace if necessary

R : Replace

NORMAL MAINTENANCE SCHEDULE - PETROL ENGINE (CONT.)

MAINTENANCE INTERVALS	Number of months or driving distance, whichever comes first									
	Kmsx1,000	10	20	30	40	50	60	70	80	80
MAINTENANCE ITEM	Months	12	24	36	48	60	72	84	96	96
	Years	1	2	3	4	5	6	7	8	8
Tyre Pressure, condition & rotation	I,TR	I,TR	I,TR	I,TR	I,TR	I,TR	I,TR	I,TR	I,TR	I,TR
Fuel lines, hoses and connections	I	I	I	I	I	I	I	I	I	I
Driveshafts & boots	I	I	I	I	I	I	I	I	I	I
Fluid leakages	I	I	I	I	I	I	I	I	I	I
Front and rear wheel bearings & bushes	Inspect and if necessary, adjust, clean or replace									
Parking brake (disc/drum ,pad/shoe & operation)	C	C	C	C	C	C	C	C	C	C
Wheel Alignment & Balancing	Inspect and if necessary, adjust									
FINAL CHECKS										
Bolt and nuts on chasis and body	I	I	I	I	I	I	I	I	I	I
Lubricate locks & hinges	L	L	L	L	L	L	L	L	L	L
Check all electrical systems (Drive belts, alternator)	I	I	I	I	I	I	I	I	I	I
Warning lights operation & GDS system check	I	I	I	I	I	I	I	I	I	I
Ext & int. lights, horn & gauges	I	I	I	I	I	I	I	I	I	I

I : Inspect and if necessary adjust,top-up, clean or replace

C : Clean and Replace if necessary

R : Replace

TR : Tyre Rotation

L : Lubricate

NORMAL MAINTENANCE SCHEDULE - PETROL ENGINE (CONT.)

MAINTENANCE INTERVALS	Number of months or driving distance, whichever comes first									
	Kmsx1,000	10	20	30	40	50	60	70	80	
MAINTENANCE ITEM	Months	12	24	36	48	60	72	84	96	
	Years	1	2	3	4	5	6	7	8	
Power window		I	I	I	I	I	I	I	I	
Sunroof operation (if equipped)		C	C	C	C	C	C	C	C	
All seat belt operation		I	I	I	I	I	I	I	I	
Road test		Inspect if reqd.								

I : Inspect and if necessary adjust,top-up, clean or replace C : Clean and Replace if necessary

R : Replace

Maintenance Under Severe Usage and Low Mileage Conditions - Petrol Engine

The following items must be serviced more frequently on cars mainly used under severe driving conditions.

Refer to the chart below for the appropriate maintenance intervals.

R : Replace or change.

I : Inspect and if necessary, adjust, correct, clean or replace.

Maintenance item	Maintenance operation	Maintenance Intervals	Driving condition
Engine oil and engine oil filter	R	Replace every 8,000 km (4,500 miles) or 6 months	A, B, C, D, E, F, G, H, I, J, K, L
Air cleaner filter	R	Replace more frequently depending on the condition	C, E
Spark plugs	R	Replace more frequently depending on the condition	A, B, F, G, H, I, K
Steering gear rack, linkage and boots	I	Inspect more frequently depending on the condition	C, D, E, F, G
Front suspension ball joints	I	Inspect more frequently depending on the condition	C, D, E, F, G
Disc brakes and pads, calipers and rotors	I	Inspect more frequently depending on the condition	C, D, E, G, H
Parking brake (if equipped)	I	Inspect more frequently depending on the condition	C, D, G, H
Drive shaft and boots	I	Inspect more frequently depending on the condition	C, D, E, F, G, H, I, K
Cabin air filter	R	Replace more frequently depending on the condition	C, E, G
Automatic transmission fluid	R	Every 100,000 km (62,000 miles)	A, C, F, G, H, I, K

Severe driving conditions

- A. Repeated short distance driving
- B. Extensive engine idling or low speed driving for long distances
- C. Driving on rough, dusty, muddy, unpaved, graveled or salt-spread roads
- D. Driving in areas using salt or other corrosive materials or in very cold weather
- E. Driving in heavy dust conditions
- F. Driving in heavy traffic area
- G. Driving on uphill, downhill, or mountain roads repeatedly
- H. Using for towing or camping, and driving with loads on the roof
- I. Driving for patrol car, taxi, other commercial use of vehicle towing
- J. Frequently driving under high speed or rapid acceleration/deceleration
- K. Frequently driving in stop-and-go conditions
- L. Engine oil usage which is not recommended (Mineral type, Semi-synthetic, Lower grade spec, etc)

NORMAL MAINTENANCE SCHEDULE - DIESEL ENGINE

MAINTENANCE INTERVALS	Number of months or driving distance, whichever comes first							
	10	20	30	40	50	60	70	80
Kmsx1,000	12	24	36	48	60	72	84	96
Months	1	2	3	4	5	6	7	8
Years								
MAINTENANCE ITEM								
ENGINE BAY								
Engine oil & filter *1 *2	R	R	R	R	R	R	R	R
Drive belt *3	-	I	-	I	-	I	-	I
Timing Belt	Inspect every 120,000 km (80,000 miles), Replace every 240,000 km (160,000 miles)							
Timing Belt System (Timing belt, Water pump, Tensioner, Idler)	Replace every 240,000 km (160,000 miles)							
Air cleaner filter	C	R	C	R	C	R	C	R
Battery condition & specific gravity	I	I	I	I	I	I	I	I
Hoses (Vacuum/ EGR / VGT/ WGT)	I	I	I	I	I	I	I	I
Tensioner/idler/damper pulley	Inspect when replacing the drive belt or timing belt/chain							
Brake/Clutch fluid	Inspect at every service; Replace at every 40,000 Km or 36 months							
Engine Coolant (topup & specify gravity) *6	Inspect at every service; Replace first at 100,000 Km or 60 months ; then at every 40,000 Km or 24 months *7							
Automatic Transmission fluid (if equipped)	No Check ; No Service reqd.							

I : Inspect and if necessary adjust,top-up, clean or replace C : Clean and Replace if necessary

R : Replace

NORMAL MAINTENANCE SCHEDULE - DIESEL ENGINE (CONT.)

MAINTENANCE INTERVALS	Number of months or driving distance, whichever comes first										
	10	20	30	40	50	60	70	80			
MAINTENANCE ITEM	Kmsx1,000	Months	Years	12	24	36	48	60	72	84	96
VEHICLE ON FLOOR				1	2	3	4	5	6	7	8
Wiper (wiper blade , washer fluid)		I	I	I	I	I	I	I	I	I	I
Brake/Clutch (Pedal free play/Pipes/Hoses/Connectors)		I	I	I	I	I	I	I	I	I	I
Fuel filler cap		I	I	I	I	I	I	I	I	I	I
Climate control air filter		R	R	R	R	R	R	R	R	R	R
Check AC system (refrigerant/Compressor)		I	I	I	I	I	I	I	I	I	I
Cooling system (water pump,hoses) & leakage		I	I	I	I	I	I	I	I	I	I
VEHICLE ON LIFT											
Steering gear rack, linkage and boots		I	I	I	I	I	I	I	I	I	I
Exhaust system (leakages & damages)		I	I	I	I	I	I	I	I	I	I
Fuel filter **4		I	R	I	R	I	R	I	R	I	R
Front & rear suspension (linkages & ball joints)		I	I	I	I	I	I	I	I	I	I
Urea solution lines, hoses and connections		I	I	I	I	I	I	I	I	I	I
Urea solution tank cap		I	I	I	I	I	I	I	I	I	I

I : Inspect and if necessary adjust,top-up, clean or replace
 R : Replace
 C : Clean and Replace if necessary

NORMAL MAINTENANCE SCHEDULE - DIESEL ENGINE (CONT.)

MAINTENANCE INTERVALS	Number of months or driving distance, whichever comes first									
	10	20	30	40	50	60	70	80		
Kmsx1,000	12	24	36	48	60	72	84	96		
Months	1	2	3	4	5	6	7	8		
Years	I,TR	I,TR	I,TR	I,TR	I,TR	I,TR	I,TR	I,TR		
MAINTENANCE ITEM										
Tyre Pressure, condition & rotation	I,TR	I,TR	I,TR	I,TR	I,TR	I,TR	I,TR	I,TR		
Fuel lines, hoses and connections	I	I	I	I	I	I	I	I		
Driveshafts & boots	I	I	I	I	I	I	I	I		
Fluid leakages	I	I	I	I	I	I	I	I		
Front and rear wheel bearings & bushes	Inspect and if necessary, adjust, clean or replace									
Parking brake (disc/drum ,pad/shoe & operation)	C	C	C	C	C	C	C	C		
Wheel Alignment & Balancing	Inspect and if necessary, adjust									
Transfer case oil (4WD) *8	-	-	-	-	-	-	-	-		
Rear differential oil (4WD) *8	-	-	-	-	-	-	-	-		
Propeller shaft (4WD)	-	I	-	I	-	I	-	I		
FINAL CHECKS										
Bolt and nuts on chasis and body	I	I	I	I	I	I	I	I		
Lubricate locks & hinges	L	L	L	L	L	L	L	L		
Check all electrical systems (Drive belts ,alternator)	I	I	I	I	I	I	I	I		
Warning lights operation & GDS system check	I	I	I	I	I	I	I	I		
Ext & int. lights, horn & gauges	I	I	I	I	I	I	I	I		

I : Inspect and if necessary adjust,top-up, clean or replace C : Clean and Replace if necessary TR : Tyre Rotation L : Lubricate
R : Replace

NORMAL MAINTENANCE SCHEDULE - DIESEL ENGINE

MAINTENANCE INTERVALS	Number of months or driving distance, whichever comes first									
	10	20	30	40	50	60	70	80		
Kmsx1,000	12	24	36	48	60	72	84	96		
Months	1	2	3	4	5	6	7	8		
Years										
MAINTENANCE ITEM										
Power window	I	I	I	I	I	I	I	I	I	I
Sunroof operation (if equipped)	C	C	C	C	C	C	C	C	C	C
All seat belt operation	I	I	I	I	I	I	I	I	I	I
Road test	Inspect if reqd.									

I : Inspect and if necessary adjust,top-up, clean or replace C : Clean and Replace if necessary

R : Replace

Maintenance Under Severe Usage and Low Mileage Conditions - Diesel Engine

The following items must be serviced more frequently on cars mainly used under severe driving conditions.

Refer to the chart below for the appropriate maintenance intervals.

R : Replace or change.

I : Inspect and if necessary, adjust, correct, clean or replace.

Maintenance item		Maintenance operation	Maintenance Intervals	Driving condition
Engine oil and engine oil filter	Smartstream D2.0	R	Replace every 5,000 km (3,000 miles) or 6 months	A, B, C, D, E, F, G, H, I, J, K, L
Air cleaner filter		R	Replace more frequently depending on the condition	C, E
Steering gear rack, linkage and boots		I	Inspect more frequently depending on the condition	C, D, E, F, G
Front suspension ball joints		I	Inspect more frequently depending on the condition	C, D, E, F, G
Disc brakes and pads, calipers and rotors		I	Inspect more frequently depending on the condition	C, D, E, G, H
Parking brake (if equipped)		I	Inspect more frequently depending on the condition	C, D, G, H
Drive shaft and boots		I	Inspect more frequently depending on the condition	C, D, E, F, G, H, I, K
Cabin air filter		R	Replace more frequently depending on the condition	C, E, G
Automatic transmission fluid		R	Every 100,000 km (62,000 miles)	A, C, F, G, H, I, K
Rear differential oil (4WD)		R	Every 120,000 km (80,000 miles)	C, D, E, G, H, I, J
Transfer case oil (4WD)		R	Every 120,000 km (80,000 miles)	C, D, E, G, H, I, J
Propeller shaft (4WD)		I	Every 15,000 km (10,000 miles) or 12 months	C, E

Severe driving conditions

- A. Repeated short distance driving
- B. Extensive engine idling or low speed driving for long distances
- C. Driving on rough, dusty, muddy, unpaved, graveled or salt-spread roads
- D. Driving in areas using salt or other corrosive materials or in very cold weather
- E. Driving in heavy dust conditions
- F. Driving in heavy traffic area
- G. Driving on uphill, downhill, or mountain roads repeatedly
- H. Using for towing or camping, and driving with loads on the roof
- I. Driving for patrol car, taxi, other commercial use of vehicle towing
- J. Frequently driving under high speed or rapid acceleration/deceleration
- K. Frequently driving in stop-and-go conditions
- L. Engine oil usage which is not recommended (Mineral type, Semi-synthetic, Lower grade spec, etc)

EXPLANATION OF SCHEDULED MAINTENANCE ITEMS

Engine oil and filter

The engine oil and filter should be changed at the intervals specified in the maintenance schedule. If the vehicle is being driven in severe conditions, more frequent oil and filter changes are required.

Drive belts

Inspect all drive belts for evidence of cuts, cracks, excessive wear or oil saturation and replace if necessary.

Drive belts should be checked periodically for proper tension and adjusted as necessary.



Information

When you are inspecting the belt, turn the engine off.

Fuel lines, fuel hoses and connections

Check the fuel lines, fuel hoses and connections for leakage and damage. We recommend an authorized HYUNDAI dealer replace any damaged or leaking parts immediately.

Fuel filter (for gasoline engine)

The fuel filter is considered to be maintenance free but periodic inspection is recommended for this maintenance depends on fuel quality. If there are some important matters like fuel flow restriction, surging, loss of power, hard starting problem etc., replace the fuel filter immediately. We recommend that you consult an authorized HYUNDAI dealer for details.

Fuel filter (cartridge) (for diesel engine)

A clogged filter can limit the speed at which the vehicle may be driven, damage the emission system and cause multiple issues such as hard starting. If an excessive amount of foreign matter accumulates in the fuel tank, the filter may require replacement more frequently. After installing a new filter, run the engine for several minutes, and check for leaks at the connections. We recommend that the fuel filter be installed by an authorized HYUNDAI dealer.

Vapor hose and fuel filler cap

The vapor hose and fuel filler cap should be inspected at those intervals specified in the maintenance schedule. Make sure a new vapor hose or fuel filler cap is correctly replaced.

Vacuum crankcase ventilation hoses (if equipped)

Inspect the surface of hoses for evidence of heat and/or mechanical damage. Hard and brittle rubber, cracking, tears, cuts, abrasions, and excessive swelling indicate deterioration. Particular attention should be paid to examine those hose surfaces nearest to high heat sources, such as the exhaust manifold.

Inspect the hose routing to ensure that the hoses do not come in contact with any heat source, sharp edges or moving component which might cause heat damage or mechanical wear. Inspect all hose connections, such as clamps and couplings, to make sure they are secure, and that no leaks are present. Hoses should be replaced immediately if there is any evidence of deterioration or damage.

Air cleaner filter

We recommend that the air cleaner filter be replaced by an authorized HYUNDAI dealer.

Spark plugs (for gasoline engine)

Make sure to install new spark plugs of the correct heat range.

When assembling parts, be sure to wipe out foreign substances inside and outside of the boot bottom of the ignition coil and the insulator of the spark plug with a soft cloth to prevent contamination of the spark plug insulator.



WARNING

Do not disconnect and inspect spark plugs when the engine is hot. You may burn yourself.

Cooling system

Check cooling system components, such as radiator, coolant reservoir, hoses and connections for leakage and damage. Replace any damaged parts.

Engine coolant

The coolant should be changed at the intervals specified in the maintenance schedule.

Automatic transmission fluid

Automatic transmission fluid should not be checked under normal usage conditions.

We recommend that the automatic transmission fluid be changed by an authorized HYUNDAI dealer according to the maintenance schedule.



Information

Automatic transmission fluid color is red when new.

As the vehicle is driven, the automatic transmission fluid will begin to look darker.

This is a normal condition. It does not need to be replaced based on the color change.

NOTICE

The use of a non-specified fluid could result in transmission malfunction and failure.

Use only specified automatic transmission fluid. (Refer to "Recommended Lubricants and Capacities" section in chapter 2.)

Brake hoses and lines

Visually check for proper installation, chafing, cracks, deterioration and any leakage. Replace any deteriorated or damaged parts immediately.

Brake/clutch fluid (if equipped)

Check brake/clutch fluid level in the brake fluid reservoir. The level should be between "MIN" (Minimum) and "MAX" (Maximum) marks on the side of the reservoir. Use only hydraulic brake/clutch fluid conforming to DOT 4 specification.

Parking brake (if equipped)

Inspect the parking brake system including the parking brake lever and cables.

Brake discs, pads, calipers and rotors

Check the pads, the disc, and the rotor for any excessive wear-out. Inspect calipers for any fluid leakage.

For more information on checking the pads or lining wear limit, refer to the HYUNDAI web site.

<http://service.hyundai-motor.com>

Propeller shaft

Check the propeller shaft, boots, clamps, rubber couplings and center-bearing rubber for cracks, deterioration, or damage. Replace any damaged parts and if necessary, repack the grease.

Suspension mounting bolts

Check the suspension connections for looseness or damage. Retighten to the specified torque.

Steering gear box, linkage & boots/lower arm ball joint

With the vehicle stopped and the engine off, check for excessive free-play in the steering wheel. Check the linkage for bends or damage. Check the dust boots and ball joints for deterioration, cracks, or damage.

Replace any damaged parts.

Drive shafts and boots

Check the drive shafts, boots and clamps for cracks, deterioration, or damage. Replace any damaged parts and, if necessary, repack the grease.

Air conditioning refrigerant

Check the air conditioning lines and connections for leakage and damage.

ENGINE OIL

Checking the engine oil level

Engine oil is used for lubricating, cooling, and operating various hydraulic components in the engine. Engine oil consumption while driving is normal, and it is necessary to check and refill the engine oil regularly. Also, check and refill the oil level within the recommended maintenance schedule to prevent deterioration of oil performance.

Check the engine oil following the below procedure.

Gasoline engine

1. Follow all of the oil manufacturer's precautions.
2. Be sure the vehicle is on the level ground in P (Park) with the parking brake set and the wheels blocked.
3. Turn the engine on and warm the engine up until the coolant temperature reaches a constant normal temperature.
4. Turn the engine off, remove the oil filler cap and pull the dipstick out. Wait for 15 minutes for the oil to return to the oil pan.
5. Wipe the dipstick clean and re-insert it fully.

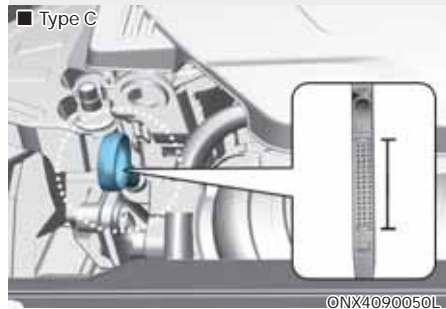
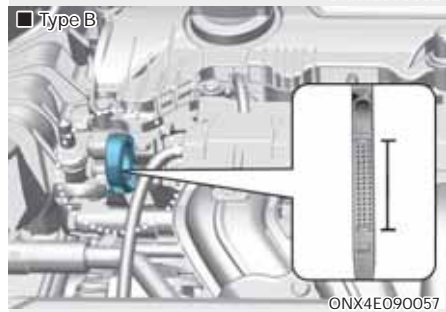
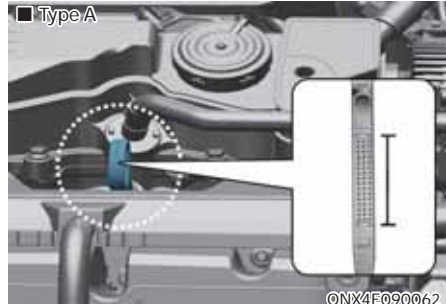

6. Pull the dipstick out again and check the level. The level should be between F (Full) and L (Low).

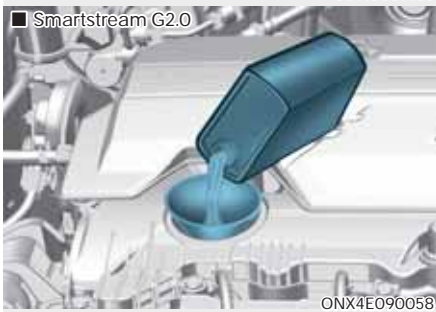

7. If the oil level is below the L, add enough oil to bring the level to F.

Use only the specified engine oil (Refer to "Recommended Lubricants and Capacities" section in chapter 2).

NOTICE

To prevent damage to your engine:

- Do not spill engine oil when adding or changing engine oil. Wipe off spilled oil immediately.
- The engine oil consumption may increase while you break in a new vehicle and it will be stabilized after driving 6,000 km (4,000 miles).
- The engine oil consumption can be affected by driving habits, climate conditions, traffic conditions, oil quality, etc. Therefore, it is recommended that you inspect the engine oil level regularly and refill it if necessary.

Diesel engine

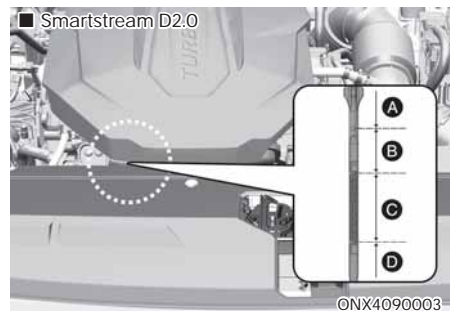

Range	Required action
A	Recommended to contact an authorized HYUNDAI dealer.
B	Do not refill engine oil.
C	You may add engine oil as long as the oil level does not go above the C range.
D	You must add oil and make sure that the oil level is in the C Range.

Engine oil is used for lubricating, cooling, and operating various hydraulic components in the engine. Engine oil consumption while driving is normal, and it is necessary to check and refill the engine oil regularly. Also, check and refill the oil level within the recommended maintenance schedule to prevent deterioration of oil performance.

Check the engine oil following the below procedure.

1. Follow all of the oil manufacturer's precautions.
2. Be sure the vehicle is on the level ground in P (Park) with the parking brake set and the wheels blocked.
3. Turn the engine on and warm the engine up until the coolant temperature reaches a constant normal temperature.
4. Turn the engine off, remove the oil filler cap and pull the dipstick out. Wait for 15 minutes for the oil to return to the oil pan.
5. Wipe the dipstick clean and re-insert it fully.
6. Pull out the dipstick out again and check the level. The level should be in the C range.



If the level is in the D range, add enough engine oil to bring the level up to the C range.

Use only the specified engine oil (Refer to "Recommended Lubricants and Capacities" section in chapter 2).

NOTICE

To prevent damage to your engine:

- Do not spill engine oil when adding or changing engine oil. Wipe off spilled oil immediately.
- The engine oil consumption may increase while you break in a new vehicle and it will be stabilized after driving 6,000 km (4,000 miles).
- The engine oil consumption can be affected by driving habits, climate conditions, traffic conditions, oil quality, etc. Therefore, it is recommended that you inspect the engine oil level regularly and refill it if necessary.

Checking the engine oil and filter



- The lubrication, rust prevention, cooling, and cleaning effect of the engine oil will gradually degrade during its use. We recommend that the engine oil and filter be changed by an authorized HYUNDAI dealer according to the Engine Oil Change Interval Alert function or the Maintenance Schedule at the beginning of this chapter.
- If the maintenance schedule to replace engine oil is exceeded, the engine oil performance may deteriorate and the engine condition may be affected. Therefore, replace the engine oil according to the maintenance schedule.
- To keep the engine in optimal condition, use the recommended engine oil. If the recommended engine oil is not used, replace it according to the maintenance schedule under severe usage conditions.
- The purpose of the maintenance schedule for engine oil replacement is to prevent oil deterioration and it is irrelevant to oil consumption. Check and refill engine oil regularly.

i Information

When the oil pressure is low due to insufficient engine oil, the Engine Oil Pressure (油圧) warning light will illuminate. In addition, the enhanced engine protection system, which limits the engine's power is activated and the Malfunction Indicator Lamp (故障灯) will illuminate when the vehicle is driven in this state continuously. When oil pressure is restored, the Engine Oil Pressure warning light will turn off and the engine power will no longer be limited. However, for gasoline 2.5 gdi or 2.5 turbo gdi engine, when the oil pressure is restored, the warning light and the enhanced engine protection system will turn off after the engine is restarted.

⚠ CAUTION

The engine oil is very hot immediately after the vehicle has been driven and can cause burns during replacement. Replace the engine oil after the engine oil has cooled down.

⚠ WARNING

Used engine oil may cause irritation or cancer of the skin if left in contact with the skin for prolonged periods of time. Used engine oil contains chemicals that have caused cancer in laboratory animals. Always protect your skin by washing your hands thoroughly with soap and warm water as soon as possible after handling used oil.

ENGINE COOLANT

The high-pressure cooling system has a reservoir filled with year-round antifreeze coolant. The reservoir is filled at the factory.

Check the antifreeze protection and coolant level at least once a year, at the beginning of the winter season and before traveling to a colder climate.

Checking the coolant level



Check the condition and connections of all cooling system hoses and heater hoses. Replace any swollen or deteriorated hoses.

The coolant level should be filled between the MAX and the MIN marks on the side of the coolant reservoir when the engine is cool.

If the coolant level is low, add enough distilled (deionized) water to bring the level to the MAX mark, but do not overfill. If frequent additions are required, we recommend that you see an authorized HYUNDAI dealer for a cooling system inspection.

WARNING



Never remove the engine coolant cap or the drain plug while the engine and radiator are hot. Hot coolant and steam may blow out under pressure, causing serious injury.

Turn the vehicle off and wait until the engine cools down. Use extreme care when removing the engine coolant cap. Wrap a thick towel around it, and turn it counterclockwise slowly to the first stop. Step back while the pressure is released from the cooling system. When you are sure all the pressure has been released, press down on the cap, using a thick towel, and continue turning counterclockwise to remove it.

i Information

The coolant level is influenced by the engine temperature. Before checking or refilling the coolant, turn the engine off.

! WARNING



The electric motor for the cooling fan may continue to operate or start up when the engine is not running and can cause serious injury. Keep hands, clothing and tools away from the rotating fan blades of the cooling fan.

Always turn off the vehicle unless the vehicle has to be inspected with the engine on. Be cautious as the cooling fan may operate if the negative (-) battery terminal is not disconnected.

! WARNING

Make sure the coolant cap is properly closed after refilling coolant. Otherwise the engine could be overheated while driving.

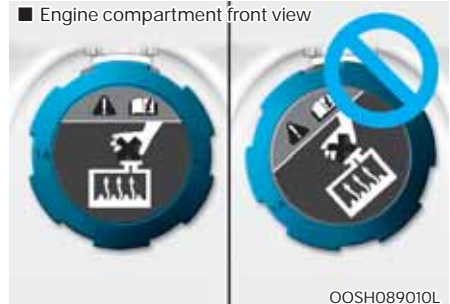

1. Check if the coolant cap label is straight in front.



2. Make sure that the tiny protrusions inside the coolant cap are securely interlocked.

Recommended coolant

- When adding coolant, use only deionized water, distilled water or soft water for your vehicle and never mix hard water in the coolant filled at the factory.
- An incorrect coolant mixture can result in severe malfunction or engine damage.
- The engine in your vehicle has aluminum engine parts and must be protected by an phosphate-based ethylene glycol coolant to prevent corrosion and freezing.
- Do not use alcohol or methanol coolant or mix them with the specified coolant.
- Do not use a solution that contains more than 60% antifreeze or less than 35% antifreeze, which would reduce the effectiveness of the solution.

For mixing percentage, refer to the following table:

Ambient Temperature	Mixture Percentage (volume)	
	Antifreeze	Water
-15°C (5°F)	35	65
-25°C (-13°F)	40	60
-35°C (-31°F)	50	50
-45°C (-49°F)	60	40

i Information

If in doubt about the mix ratio, a 50% water and 50% antifreeze mix is the easiest to mix together as it will be the same quantity of each. It is suitable to use for most temperature ranges of -35°C (-31°F) and higher.

Changing coolant

We recommend that coolant be changed by an authorized HYUNDAI dealer according to the Maintenance Schedule at the beginning of this chapter.

! WARNING

Do not use engine coolant or antifreeze in the washer fluid reservoir.

Engine coolant can severely obscure visibility when sprayed on the windshield and may cause loss of vehicle control resulting in an accident.

Engine coolant may also cause damage to paint and body trim.

NOTICE

To prevent damage to engine parts, put a thick towel around the engine coolant cap before refilling the coolant to prevent the coolant from overflowing into engine parts, such as the alternator.

BRAKE/CLUTCH FLUID (IF EQUIPPED)

Checking the brake/clutch fluid level

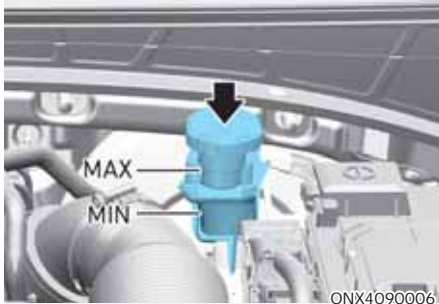

Check the fluid level in the reservoir periodically. The fluid level should be between MAX and MIN marks on the side of the reservoir.

Before removing the reservoir cap and adding brake/clutch fluid, clean the area around the reservoir cap thoroughly to prevent brake/clutch fluid contamination.

If the level is low, add fluid to the MAX level. The level will fall with accumulated mileage. This is a normal condition associated with the wear of the brake linings.

If the fluid level is excessively low, we recommend that the system be checked by an authorized HYUNDAI dealer.

i Information

Use only the specified brake/clutch fluid. Refer to “Recommended lubricants and capacities” in chapter 2.

i Information

Before removing the brake/clutch filler cap, read the warning on the cap.

i Information

Clean the filler cap before removing. Use only DOT4 brake/clutch fluid from a sealed container.

! WARNING

If the brake/clutch system requires frequent additions of fluid this could indicate a leak in the brake/clutch system. We recommend that the vehicle be inspected by an authorized HYUNDAI dealer.

! WARNING

Do not let brake/clutch fluid enter into your eyes. If brake/clutch fluid gets in your eyes, flush your eyes with clean water for at least 15 minutes and get immediate medical attention.

NOTICE

- Do not allow brake/clutch fluid to contact the vehicle's body paint, as it will result in paint damage.
- NEVER use brake/clutch fluid which has been exposed to open air for an extended time, as its quality cannot be guaranteed.
- Don't put in the wrong type of fluid. A few drops of mineral-based oil, such as engine oil in your brake/clutch system can damage system parts.

WASHER FLUID

Checking the washer fluid level

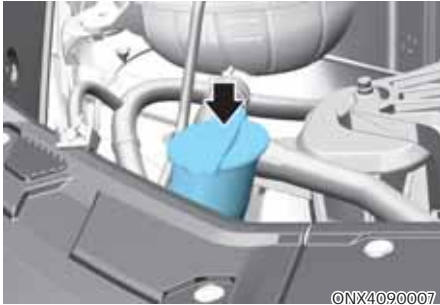

Check the fluid level in the washer fluid reservoir and add fluid if necessary. Plain water may be used if washer fluid is not available. However, use washer solvent with antifreeze characteristics in cold climates to prevent freezing.



WARNING

To prevent serious injury or death, take the following safety precautions when using washer fluid:

- Do not use engine coolant or antifreeze in the washer fluid reservoir. Engine coolant can severely obscure visibility when sprayed on the windshield and may cause loss of vehicle control resulting in an accident or damage to paint and body trim.
- Do not allow sparks or flame to contact the washer fluid or the washer fluid reservoir. Washer fluid may contain alcohol and can be flammable.
- Do not drink washer fluid and avoid contact with skin. Washer fluid is harmful to humans and animals.
- Keep washer fluid away from children and animals.

FUEL FILTER (FOR DIESEL ENGINE)

Draining water from fuel filter

The fuel filter in the diesel engine separates water from fuel and prevents water from accumulating.

When water is accumulated inside the fuel filter, the fuel filter (⚠) warning light illuminates with ignition switch or Engine Start/Stop button in the ON position.

If this occurs, we recommend that you have the system checked by an authorized HYUNDAI dealer.

NOTICE

When accumulated water is not drained at the proper timing, water may permeate in the fuel filter, damaging the major vehicle components, such as the fuel system.

Fuel filter cartridge replacement

We recommend the fuel filter cartridge be replaced by an authorized HYUNDAI dealer according to the Maintenance Schedule at the beginning of this chapter.

AIR CLEANER

Filter replacement

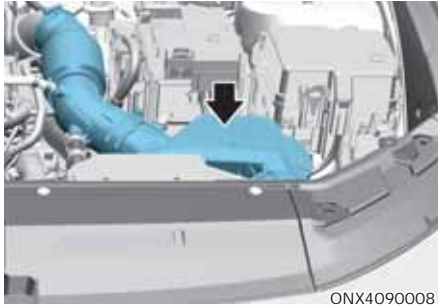

The air cleaner filter can be cleaned for inspection using compressed air. Do not attempt to wash or to rinse it, as water will damage the filter. If soiled, the air cleaner filter must be replaced.



1. Pull up the air cleaner filter cover (1).



2. Pull down the lever to the UNLOCK (2) position.



3. Replace the air cleaner filter.
4. Reassemble the air cleaner cover in the reverse order.

i Information

If the vehicle is operated in extremely dusty or sandy areas, replace the element more often than the usual recommended intervals (refer to “Maintenance Under Severe Usage Conditions” in this chapter).

NOTICE

- Do not drive with the air cleaner filter removed. This will result in excessive engine wear.
- When removing the air cleaner filter, be careful that dust or dirt does not enter the air intake, or damage may result.
- Use HYUNDAI genuine parts or the equivalent specified for your vehicle. Use of non-genuine parts could damage the air flow sensor.

CABIN AIR FILTER

Filter inspection

The cabin air filter should be replaced according to the Maintenance Schedule. If the vehicle is operated in severely air-polluted cities or on dusty rough roads for a long period, it should be inspected more frequently and replaced sooner. Replace the cabin air filter by following the procedure below and be careful to avoid damaging other components.

Filter replacement

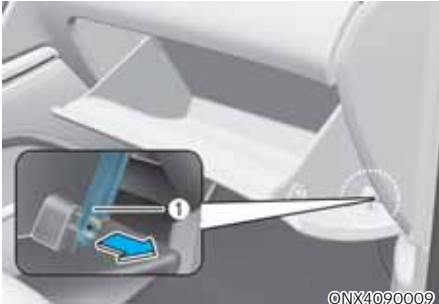

1. Open the glove box and remove the support rod (1).

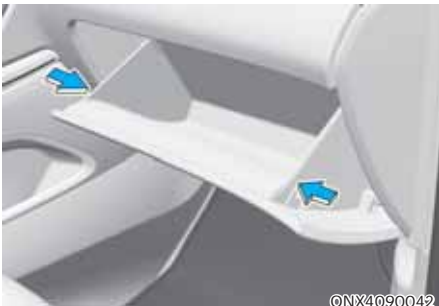

2. Remove the stoppers on both sides to allow the glove box to hang freely on the hinges.

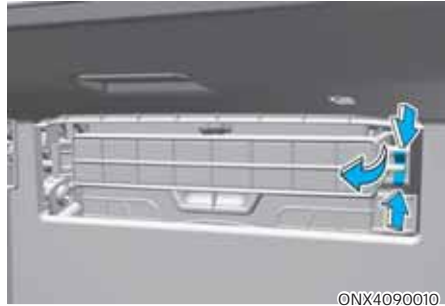

3. Press and hold the lock on the right side of the cover.
4. Pull out the cover.
5. Replace the cabin air filter.
6. Reassemble in the reverse order of disassembly.

NOTICE

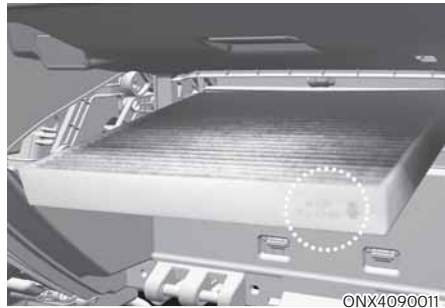

Install a new cabin air filter in the correct direction with the arrow symbol (↓) facing downwards, to prevent noise and increase effectiveness.

WIPER BLADES

Blade inspection

Contamination of either the windshield or the wiper blades with foreign matter can reduce the effectiveness of the windshield wipers.

Common sources of contamination are insects, tree sap, and hot wax treatments used by some commercial car washes. If the blades are not wiping properly, clean both the window and the blades with a good cleaner or mild detergent, and rinse thoroughly with clean water.

NOTICE

To prevent damage to the wiper blades, arms or other components, do not:

- Use gasoline, kerosene, paint thinner, or other solvents on or near them.
- Attempt to move the wipers manually.
- Use non-specified wiper blades.

i Information

Commercial hot waxes applied by automatic car washes have been known to make the windshield difficult to clean.

i Information

Wiper blades are consumable items. Normal wear of the wipers may not be covered by your vehicle warranty.

Blade replacement

When the wipers no longer clean adequately, the blades may be worn or cracked, and require replacement.

NOTICE

To prevent damage to the wiper arms or other components, do not attempt to move the wipers manually.

NOTICE

The use of a non-specified wiper blade could result in wiper malfunction and failure.

NOTICE

- In order to prevent damage to the hood and the wiper arms, the wiper arms should only be lifted when in the top wiping position.
- Always return the wiper arms to the windshield before driving.

Front windshield wiper service positions

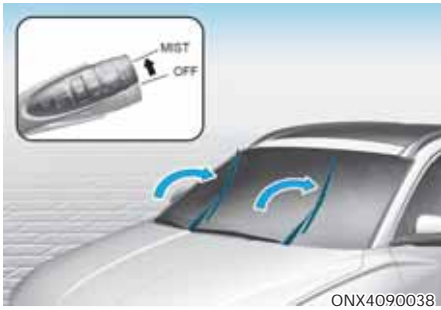

This vehicle has a "hidden" wiper design which means that the wipers cannot be lifted when they are in their bottom resting position.

1. Within 20 seconds of turning off the engine, lift and hold the wiper lever up to the MIST (or down to the V) position for about 2 seconds until the wipers move to the top wiper position.
2. At this time you can lift the wipers off the windshield.
3. Gently put the wipers back down onto the windshield.
4. Turn the wipers to any ON position to return the wipers to the bottom resting position.

Blade replacement

Type A



1. Raise the wiper arm and turn the wiper blade assembly to expose the plastic locking clip.

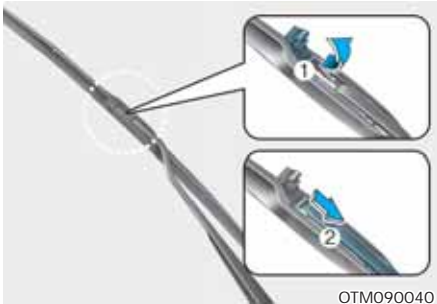

OTM090040

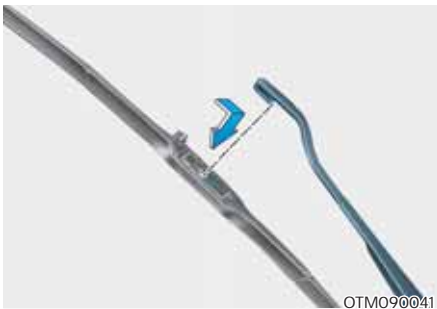

OTM090041

2. Press the clip and slide the blade assembly downward.
3. Lift it off the arm.
4. Install the blade assembly in the reverse order of removal.

Type B

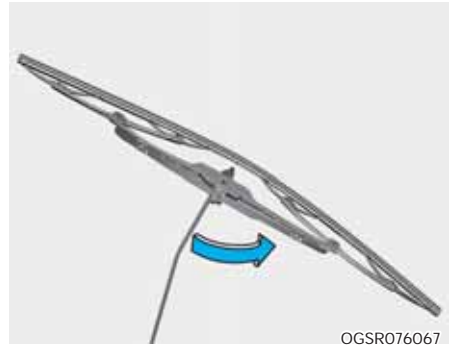

OGSR076067

1. Raise the wiper arm.

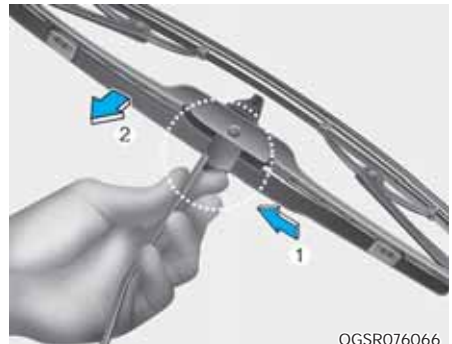

OGSR076066

2. Lift up the wiper blade clip. Then pull down the blade assembly and remove it.



3. Install the new blade assembly.
4. Return the wiper arm on the windshield.

Rear window wiper blade replacement

Move the rear wiper to the bottom middle part, and lift up the wiper arm. Pull the wiper blade to remove it.



1. Within 20 seconds after the vehicle ignition is OFF, pull down the wiper lever to MIST position for over 2 seconds until the wiper moves down to the bottom middle part.



2. Raise the wiper arm.



3. Lift up the wiper blade, and pull it out.



ONX4E090052

4. Install the new blade assembly by inserting the center part into the slot in the wiper arm until it clicks into place.

If the replacement is complete, put down the wiper arm to place it on the rear windshield, and turn the vehicle ignition to ON and operate the wipers to check the blade is installed correctly.

5. Make sure the blade assembly is installed firmly by trying to pull it slightly.

To prevent damage to the wiper arms or other components, we recommend that the wiper blade be replaced by an authorized HYUNDAI dealer.

CAUTION

If the wiper arm receives too much force while pulling the blade, the center part may be damaged.

CAUTION

- The wiper could not operate for approx. 10 seconds when the wiper is operated without washer fluid or the blades are frozen. This is not a malfunction, it is a wiper protection system activated by motor overload circuit within the wiper motor.
- The front windshield should be cleaned with water hose and wiped with clean towel with wiper blades raised up. Also, the wiper blades should be wiped clean when the grease or wax is applied to the blades.

BATTERY



WARNING

To prevent **SERIOUS INJURY** or **DEATH** to you or bystanders, always follow these precautions when working near or handling the battery:



Always read and follow instructions carefully when handling a battery.



Wear eye protection designed to protect the eyes from acid splashes.



Keep all flames, sparks, or smoking materials away from the battery.



Hydrogen is always present in battery cells, is highly combustible, and may explode if ignited.



Keep batteries out of reach of children.



Batteries contain sulfuric acid which is highly corrosive. Do not allow acid to contact your eyes, skin or clothing.

If acid gets into your eyes, flush your eyes with clean water for at least 15 minutes and get immediate medical attention. If acid gets on your skin, thoroughly wash the area. If you feel pain or a burning sensation, get medical attention immediately.

- When lifting a plastic-cased battery, excessive pressure on the case may cause battery acid to leak. Lift with a battery carrier or with your hands on opposite corners.
- Do not attempt to jump start your vehicle if your battery is frozen.
- NEVER attempt to recharge the battery when the vehicle's battery cables are connected to the battery.
- The electrical ignition system works with high voltage. NEVER touch these components with the engine running or when ignition switch or Engine Start/Stop button is in the ON position.

NOTICE

Always follow these instructions when handling your vehicle's battery to prevent damage to your battery:

- When you do not use the vehicle for a long time in a low temperature area, disconnect the battery and keep it indoors.
- Always charge the battery fully to prevent battery case damage in low temperature areas.
- Prevent liquid from wetting the battery terminals. The performance of the battery may be degraded, and may cause injury. Be cautious when loading liquid in the tailgate.
- Do not tilt the battery.
- If you connect unauthorized electronic devices to the battery, the battery may be discharged. Never use unauthorized devices.

For best battery service

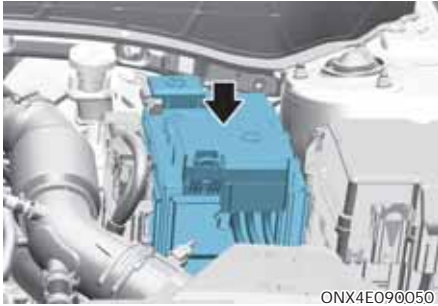

- Keep the battery securely mounted.
- Keep the battery top clean and dry.
- Keep the terminals and connections clean, tight, and coated with petroleum jelly or terminal grease.
- Rinse any spilled electrolyte from the battery immediately with a solution of water and baking soda.
- If the vehicle is not going to be used for an extended time, disconnect the battery cables.

i Information - For batteries marked with UPPER and LOWER

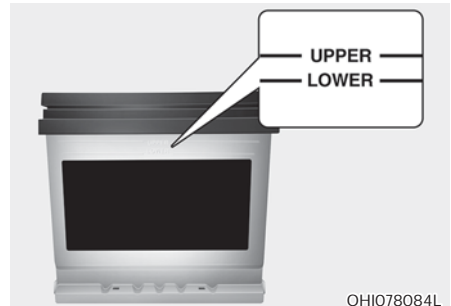

If your vehicle is equipped with a battery marked with LOWER (MIN) and UPPER (MAX) on the side, you should check the electrolyte level.

The electrolyte level should be between LOWER (MIN) and UPPER (MAX). When the electrolyte level is low, add distilled (or de-mineralized) water. (Never add sulfuric acids or other electrolyte).

Be careful not to spill distilled (or demineralized) water over the battery surface or other adjacent components.

Also, do not overfill the battery cells.

If not, it may corrode the battery or other components. Finally, securely close the cell cap. However, we recommend you to contact an authorized HYUNDAI dealer for better battery service.

Battery capacity label

■ Type A

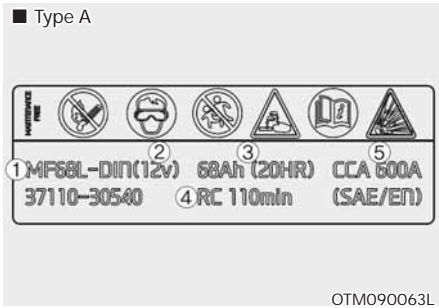

■ Type B

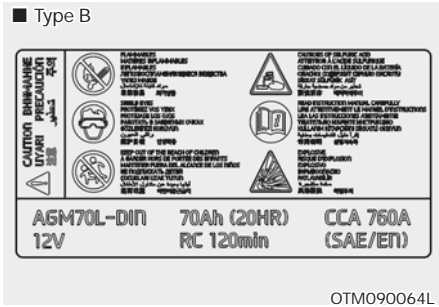

1. MF68L-DIN : The HYUNDAI model name of battery
2. 12V : The nominal voltage
3. 68Ah (20HR) : The nominal capacity (in Ampere hours)
4. RC 110min : The nominal capacity (in Ampere hours)
5. 600A : The cold-test current in amperes by SAE/EN

Battery recharging

By battery charger

Your vehicle has a maintenance-free, calcium-based battery.

- If the battery becomes discharged over a short time (because, for example, the headlamps or interior lights were left on while the vehicle was not in use), recharge it by slow charging (trickle) for 10 hours.
- If the battery gradually discharges because of high electrical load while the vehicle is being used, recharge it at 20-30A for two hours.

WARNING

Always follow these instructions when recharging your vehicle's battery to avoid the risk of **SERIOUS INJURY** or **DEATH** from explosions or acid burns:

- Before performing maintenance or recharging the battery, turn off all accessories and stop the engine.
- Keep all flames, sparks, or smoking materials away from the battery.
- Always work outdoors or in an area with plenty of ventilation.
- Wear eye protection when checking the battery during charging.
- The battery must be removed from the vehicle and placed in a well ventilated area.
- Watch the battery during charging, and stop or reduce the charging rate if the battery cells begin boiling violently.

- The negative battery cable must be removed first and installed last when the battery is disconnected. Disconnect the battery charger in the following order:
 1. Turn off the battery charger main switch.
 2. Unhook the negative clamp from the negative battery terminal.
 3. Unhook the positive clamp from the positive battery terminal.
- We recommend that you use batteries for replacement from an authorized HYUNDAI dealer.

NOTICE

AGM battery (if equipped)

- Absorbent Glass Mat (AGM) batteries are maintenance-free and we recommend that the AGM battery be serviced by an authorized HYUNDAI dealer. For charging your AGM battery, use only fully automatic battery chargers that are specially developed for AGM batteries.
- When replacing the AGM battery, we recommend that you use parts for replacement from an authorized HYUNDAI dealer.
- Do not open or remove the cap on top of the battery. This may cause leaks of internal electrolyte that could result in severe injury.

By jump starting

After a jump start from a good battery, drive the vehicle for 20-30 minutes before it is shutoff. The vehicle may not restart if you shut it off before the battery had a chance to adequately recharge. See "Jump Starting" in chapter 8 for more information on jump starting procedures.



Information



An inappropriately disposed battery can be harmful to the environment and human health. Dispose of the battery according to your local law(s) or regulation.

Reset items

The following items may need to be reset after the battery has been discharged or the battery has been disconnected.

- Auto up/down window (see chapter 5)
- Sunroof (see chapter 5)
- Trip computer (see chapter 5)
- Climate control system (see chapter 5)
- Driver position memory system (see chapter 5)
- Clock (see chapter 5)
- Infotainment system (see infotainment system manual)

TIRES AND WHEELS



WARNING

Tire failure may cause loss of vehicle control resulting in an accident. To reduce risk of **SERIOUS INJURY** or **DEATH**, take the following precautions:

- Inspect your tires monthly for proper inflation as well as wear and damage.
- The recommended cold tire pressure for your vehicle can be found in this manual and on the tire label located on the driver's side center pillar. Always use a tire pressure gauge to measure tire pressure. Tires with too much or too little pressure wear unevenly causing poor handling.
- Check the pressure of the spare every time you check the pressure of the other tires on your vehicle.
- Replace tires that are worn, show uneven wear, or are damaged. Worn tires can cause loss of braking effectiveness, steering control, or traction.
- ALWAYS replace tires with the same size, type, construction and tread pattern as each tire that was originally supplied with this vehicle. Using tires and wheels other than the recommended sizes could cause unusual handling characteristics, poor vehicle control, or negatively affect your vehicle's Anti-Lock Brake System (ABS) resulting in a serious accident.

Tire care

For proper maintenance, safety, and maximum fuel economy, you must always maintain recommended tire inflation pressures and stay within the load limits and weight distribution recommended for your vehicle.



All specifications (sizes and pressures) can be found on a label attached to the driver's side center pillar.

Recommended cold tire inflation pressures

All tire pressures (including the spare) should be checked when the tires are cold. "Cold tires" means the vehicle has not been driven for at least three hours or driven less than 1.6 km (one mile).

Warm tires normally exceed recommended cold tire pressures by 28 to 41 kPa (4 to 6 psi). Do not release air from warm tires to adjust the pressure or the tires will be under-inflated. For recommended inflation pressure, refer to "Tire and Wheels" section in chapter 2.



WARNING

Recommended pressures must be maintained for the best ride, vehicle handling, and minimum tire wear.

Over-inflation or under-inflation can reduce tire life, adversely affect vehicle handling, and lead to sudden tire failure that could result in loss of vehicle control resulting in an accident.

Severe under-inflation can lead to severe heat build-up, causing blowouts, tread separation and other tire failures that can result in the loss of vehicle control resulting in an accident. This risk is much higher on hot days and when driving for long periods at high speeds.



CAUTION

- Under-inflation results in excessive wear, poor handling and reduced fuel economy. Wheel deformation is also possible. Keep your tire pressures at the proper levels. If a tire frequently needs refilling, we recommend it be checked by an authorized HYUNDAI dealer.
- Over-inflation produces a harsh ride, excessive wear at the center of the tire tread, and a greater possibility of damage from road hazards.

Check tire inflation pressure

Check your tires, including the spare tire, once a month or more.

How to check

Use a good quality tire pressure gauge to check tire pressure. You can not tell if your tires are properly inflated simply by looking at them. Radial tires may look properly inflated when they are under-inflated.

Remove the valve cap from the tire valve stem. Press the tire gauge firmly onto the valve to get a pressure measurement. If the cold tire inflation pressure matches the recommended pressure on the tire and loading information label, no further adjustment is necessary. If the pressure is low, add air until you reach the recommended pressure. Make sure to put the valve caps back on the valve stems. Without the valve cap, dirt or moisture could get into the valve core and cause air leakage. If a valve cap is missing, install a new one as soon as possible.

If you overfill the tire, release air by pushing on the metal stem in the center of the tire valve. Recheck the tire pressure with the tire gauge. Be sure to put the valve caps back on the valve stems. Without the valve cap, dirt or moisture could get into the valve core and cause air leakage. If a valve cap is missing, install a new one as soon as possible.

Tire rotation

To equalize tread wear, HYUNDAI recommends that the tires be rotated according to the maintenance schedule or sooner if irregular wear develops.

During rotation, check the tires for correct balance.

When rotating tires, check for uneven wear and damage. Abnormal wear is usually caused by incorrect tire pressure, improper wheel alignment, out-of-balance wheels, severe braking or severe cornering. Look for bumps or bulges in the tread or side of the tire. Replace the tire if you find any of these conditions. Replace the tire if fabric or cord is visible. After rotation, be sure to bring the front and rear tire pressures to specification and check wheel nut tightness (proper torque is 11-13 kgf.m [79-94 lbf.ft]).

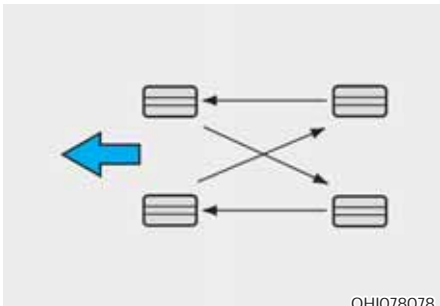

Disc brake pads should be inspected for wear whenever tires are rotated.

i Information

The outside and inside of the unsymmetrical tire is distinguishable. When installing an unsymmetrical tire, be sure to install the side marked “outside” face the outside. If the side marked “inside” is installed on the outside, it will have a negative effect on vehicle performance.

! WARNING

- Do not use the compact spare tire for tire rotation.
- Do not mix bias ply and radial ply tires under any circumstances. This may cause unusual handling characteristics that may cause loss of vehicle control resulting in an accident.

Wheel alignment and tire balance

The wheels on your vehicle were aligned and balanced carefully at the factory to give you the longest tire life and best overall performance.

In most cases, you will not need to have your wheels aligned again. However, if you notice unusual tire wear or your vehicle pulling one way or the other, the alignment may need to be reset.

If you notice your vehicle vibrating when driving on a smooth road, your wheels may need to be rebalanced.

NOTICE

Incorrect wheel weights can damage your vehicle's aluminum wheels. Use only approved wheel weights.

Tire replacement



If the tire is worn evenly, a tread wear indicator will appear as a solid band across the tread. This shows there is less than 1.6 mm (1/16 in.) of tread left on the tire. Replace the tire when this happens.

Do not wait for the band to appear across the entire tread before replacing the tire.



WARNING

To reduce the risk of DEATH or SERIOUS INJURY:

- Replace tires that are worn, show uneven wear, or are damaged. Worn tires can cause loss of braking effectiveness, steering control, and traction.
- Always replace tires with the same size as each tire that was originally supplied with this vehicle. Using tires and wheels other than the recommended sizes could cause unusual handling characteristics, poor vehicle control, or negatively affect your vehicle's Anti-Lock Brake System (ABS) resulting in a serious accident.
- When replacing tires (or wheels), it is recommended to replace the two front or two rear tires (or wheels) as a pair. Replacing just one tire can seriously affect your vehicle's handling.
- Tires degrade over time, even when they are not being used. Regardless of the remaining tread, HYUNDAI recommends that tires be replaced after six (6) years of normal service.
- Heat caused by hot climates or frequent high loading conditions can accelerate the aging process. Failure to follow this warning may cause sudden tire failure, which could lead to a loss of vehicle control resulting in an accident.

Compact spare tire replacement (if equipped)

A compact spare tire has a shorter tread life than a regular size tire. Replace it when you can see the tread wear indicator bars on the tire. The replacement compact spare tire should be the same size and design tire as the one provided with your new vehicle and should be mounted on the same compact spare tire wheel. The compact spare tire is not designed to be mounted on a regular size wheel, and the compact spare tire wheel is not designed for mounting a regular size tire.

WARNING

The original tire should be repaired or replaced as soon as possible to avoid failure of the spare and loss of vehicle control resulting in an accident. The compact spare tire is for emergency use only. Do not operate your vehicle over 80 km/h (50 mph) when using the compact spare tire.

Wheel replacement

When replacing the metal wheels for any reason, make sure the new wheels are equivalent to the original factory units in diameter, rim width and offset.

Tire traction

Tire traction can be reduced if you drive on worn tires, tires that are improperly inflated or on slippery road surfaces.

Tires should be replaced when tread wear indicators appear. To reduce the possibility of losing control, slow down whenever there is rain, snow or ice on the road.

Tire maintenance

In addition to proper inflation, correct wheel alignment helps to decrease tire wear. If you find a tire is worn unevenly, have your dealer check the wheel alignment.

When you have new tires installed, make sure they are balanced. This will increase vehicle ride comfort and tire life. Additionally, a tire should always be rebalanced if it is removed from the wheel.

Tire sidewall labeling

This information identifies and describes the fundamental characteristics of the tire and also provides the tire identification number (TIN) for safety standard certification. The TIN can be used to identify the tire in case of a recall.

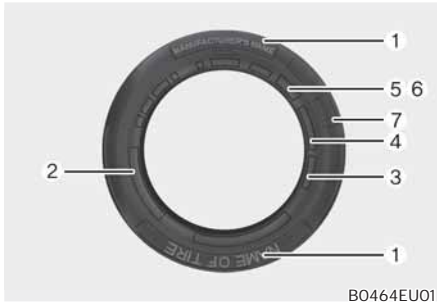

B0464EU01

1. *Manufacturer or brand name*

Manufacturer or brand name is shown.

2. *Tire size designation*

A tire's sidewall is marked with a tire size designation. You will need this information when selecting replacement tires for your car. The following explains what the letters and numbers in the tire size designation mean.

Example tire size designation:

(These numbers are provided as an example only; your tire size designator could vary depending on your vehicle.)

235/60R18 104V

235 - Tire width in millimeters.

60 - Aspect ratio. The tire's section height as a percentage of its width.

R - Tire construction code (Radial).

18 - Rim diameter in inches.

104 - Load Index, a numerical code associated with the maximum load the tire can carry.

V - Speed Rating Symbol. See the speed rating chart in this section for additional information.

Wheel size designation

Wheels are also marked with important information that you need if you ever have to replace one. The following explains what the letters and numbers in the wheel size designation mean.

Example wheel size designation:

7.5J X 18

7.5 - Rim width in inches.

J - Rim contour designation.

18 - Rim diameter in inches.

Tire speed ratings

The chart below lists many of the different speed ratings currently being used for passenger vehicle tires. The speed rating is part of the tire size designation on the sidewall of the tire. This symbol corresponds to that tire's designed maximum safe operating speed.

Speed Rating Symbol	Maximum Speed
S	180 km/h (112 mph)
T	190 km/h (118 mph)
H	210 km/h (130 mph)
V	240 km/h (149 mph)
W	270 km/h (168 mph)
Y	300 km/h (186 mph)

3. Checking tire life (TIN: Tire Identification Number)

Any tires that are over six years old, based on the manufacturing date, (including the spare tire) should be replaced by new ones. You can find the manufacturing date on the tire sidewall (possibly on the inside of the wheel), displaying the DOT Code. The DOT Code is a series of numbers on a tire consisting of numbers and English letters. The manufacturing date is designated by the last four digits (characters) of the DOT code.

DOT : XXXX XXXX OOOO

The front part of the DOT shows a plant code number, tire size and tread pattern and the last four numbers indicate week and year manufactured.

For example:

DOT XXXX XXXX 1523 represents that the tire was produced in the 15th week of 2023.

4. Tire ply composition and material

The number of layers or plies of rubber-coated fabric in the tire. Tire manufacturers also must indicate the materials in the tire, which include steel, nylon, polyester, and others. The letter "R" means radial ply construction; the letter "D" means diagonal or bias ply construction; and the letter "B" means belted-bias ply construction.

5. Maximum permissible inflation pressure

This number is the greatest amount of air pressure that should be put in the tire. Do not exceed the maximum permissible inflation pressure. Refer to the Tire and Loading Information label for recommended inflation pressure.

6. Maximum load rating

This number indicates the maximum load in kilograms and pounds that can be carried by the tire. When replacing the tires on the vehicle, always use a tire that has the same load rating as the factory installed tire.

7. Uniform tire quality grading

Quality grades can be found where applicable on the tire sidewall between tread shoulder and maximum section width.

For example:

TREADWEAR 200

TRACTION AA

TEMPERATURE A

Tread wear

The tread wear grade is a comparative rating based on the wear rate of the tire when tested under controlled conditions on a specified government test course. For example, a tire graded 150 would wear one-and-a-half times (1½) as well on the government course as a tire graded 100.

The relative performance of tires depends upon the actual conditions of their use, however, and may depart significantly from the norm due to variations in driving habits, service practices and differences in road characteristics and climate.

These grades are molded on the sidewalls of passenger vehicle tires. The tires available as standard or optional equipment on your vehicle may vary with respect to grade.

Traction - AA, A, B & C

The traction grades, from highest to lowest, are AA, A, B and C. Those grades represent the tire's ability to stop on wet pavement as measured under controlled conditions on specified government test surfaces of asphalt and concrete. A tire marked C may have poor traction performance.



WARNING

The traction grade assigned to this tire is based on straight ahead braking traction tests, and does not include acceleration, cornering, hydroplaning, or peak traction characteristics.

Temperature - A, B & C

The temperature grades are A (the highest), B and C representing the tire's resistance to the generation of heat and its ability to dissipate heat when tested under controlled conditions on a specified indoor laboratory test wheel.

Sustained high temperature can cause the material of the tire to degenerate and reduce tire life, and excessive temperature can lead to sudden tire failure. Grades B and A represent higher levels of performance on the laboratory test wheel than the minimum required by law.



WARNING

The temperature grade for this tire is established for a tire that is properly inflated and not overloaded. Excessive speed, under-inflation, over-inflation, or excessive loading, either separately or in combination, can cause heat build-up and possible sudden tire failure. This may cause loss of vehicle control resulting in an accident.

Low aspect ratio tires (if equipped)

The aspect ratio is lower than 50 on low aspect ratio tires.

Because low aspect ratio tires are optimized for handling and braking, their sidewall is a little stiffer than a standard tire. Also low aspect ratio tires tend to be wider and consequently have a greater contact patch with the road surface. In some instances they may generate more road noise compared with standard tires.



CAUTION

The side wall of a low aspect ratio tire is shorter than the normal one. Thus, the low-aspect wheel and tire are easily damaged. Follow the below instructions.

- When driving on a rough road or driving off a road, be careful not to damage the tires and wheels. After driving, inspect the tires and wheels.
- When passing over a pothole, speed bump, manhole, or curb stone, drive the vehicle slowly so as not to damage the tires and wheels.
- When there is an impact on a tire, we recommend to have the tire inspected by an authorized HYUNDAI dealer or a tire specialist.
- Inspect the tire condition and pressure every 3,000 km (1,800 miles) to prevent tire damage.
- It is difficult to recognize a tire damage only with your eyes. When there is a slight hint of a tire damage, check and replace the tire to prevent the damage caused by air leakage.
- When a tire is damaged while driving on a rough road, off a road, or over obstacles, such as a pothole, manhole, or curb stone, your warranty does not cover the damage.
- The tire information is specified on the tire side wall.

FUSES

■ Blade type



Normal



Blown

■ Cartridge type



Normal



Blown

■ Multi type



Normal

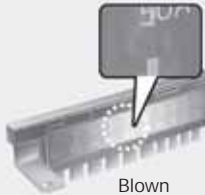

Blown

OTM078035

A vehicle's electrical system is protected from electrical overload damage by fuses.

This vehicle has 2 (or 3) fuse panels, one located in the driver's side panel bolster, the other in the engine compartment.

If any of your vehicle's lights, accessories, or controls do not work, check the appropriate circuit fuse. If a fuse has blown, the element inside the fuse will be melted or broken.

If the electrical system does not work, first check the driver's side fuse panel. Before replacing a blown fuse, turn the engine and all switches off, and then disconnect the negative battery cable. Always replace a blown fuse with one of the same rating.

If the replacement fuse blows, this indicates an electrical problem. Avoid using the system involved. We recommend that you immediately consult an authorized HYUNDAI dealer.

WARNING

NEVER replace a fuse with anything but another fuse of the same rating.

- A higher capacity fuse could cause damage and possibly cause a fire.
- Do not install a wire or aluminum foil instead of the proper fuse - even as a temporary repair. It may cause extensive wiring damage and possibly a fire.

NOTICE

Do not use a screwdriver or any other metal object to remove fuses because it may cause a short circuit and damage the system.

Instrument panel fuse replacement



1. Turn the vehicle off.
2. Turn all other switches off.
3. Open the fuse panel cover.
4. Refer to the label on the inside of the fuse panel cover to locate the suspected fuse location.

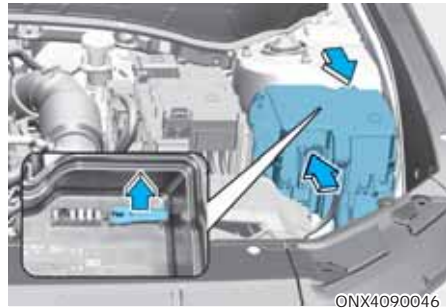

5. Pull the suspected fuse straight out. Use the removal tool provided in the engine compartment fuses panel cover.
6. Check the removed fuse; replace it if it is blown. Spare fuses are provided in the instrument panel fuse panels (or in the engine compartment fuse panel).
7. Push in a new fuse of the same rating, and make sure it fits tightly in the clips. If it fits loosely, we recommend that you consult an authorized HYUNDAI dealer.

In an emergency, if you do not have a spare fuse, use a fuse of the same rating from a circuit you may not need for operating the vehicle, such as the cigarette lighter fuse.

If the headlamps or other electrical components do not work and the fuses are undamaged, check the fuse panel in the engine compartment. If a fuse is blown, it must be replaced with the same rating.

Engine compartment panel fuse replacement

Blade fuse / Cartridge fuse

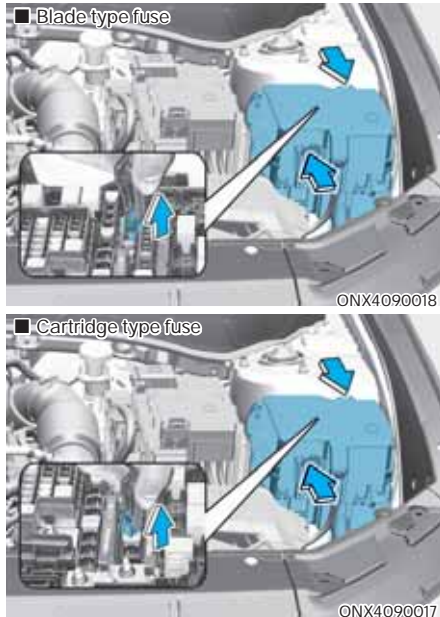

1. Turn the vehicle off.
2. Turn all other switches off.
3. Remove the fuse panel cover by pressing the tap and pulling up.
4. Check the removed fuse; replace it if it is blown. To remove or insert the fuse, use the removal tool in the engine compartment fuse panel.
5. Push in a new fuse of the same rating, and make sure it fits tightly in the clips. If it fits loosely, we recommend that you consult an authorized HYUNDAI dealer.

NOTICE

After checking the fuse panel in the engine compartment, securely install the fuse panel cover. You may hear a clicking sound if the cover is securely latched. If it is not securely latched, electrical failure may occur from water contact.

Multi fuse

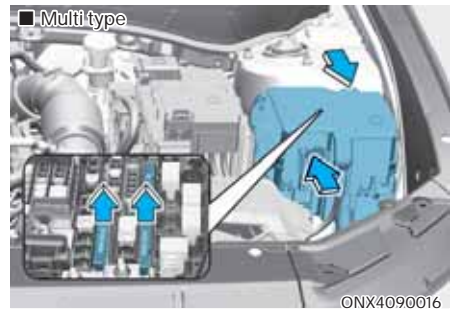

If the multi fuse or midi fuse is blown, we recommend that you consult an authorized HYUNDAI dealer.

Fuse/relay panel description Instrument panel fuse panel



ONX4090019

Inside the fuse/relay box cover, you can find the fuse/relay label describing fuse/relay names and ratings.

i Information

Not all fuse panel descriptions in this manual may be applicable to your vehicle; the information is accurate at the time of printing. When you inspect the fuse box on your vehicle, refer to the fuse box label.















91990-N9040



استخدم الفيوز ذو القياس المناسب
 используйте только предназначенные предохранители
USE THE DESIGNATED FUSE ONLY
 USE SOLO LOS FUSIBLES ESPECIFICADOS



1	REAR WIPER			SPARE	SPARE		MEMORY	E-CALL	11	ALTIMEDIA	12		13	MODULE	14	MODULE	15	CLUSTER	16	MODULE		
	20A	20A		10A	15A		10A	10A	20A	15A			10A	7.5A	7.5A	7.5A	7.5A					
17	PROXIMITY			1	MODULE	2	IBU		7	MODULE	8	A/C		9	IBU	SPARE	10	E-SHIFTER	11	ALTIMEDIA	12	MODULE
	25A	20A		20A	10A	10A	10A		7.5A	15A	7.5A		7.5A	10A	7.5A	10A	7.5A	10A				
13	FRANCE	14	SAFETY	15	AMP	16	SAFETY	17	BRAKE SWITCH	18	MODULE	19	MODULE	20	MODULE	SPARE	SPARE	21	MODULE	22		
	25A	30A	25A	30A	25A	20A	25A	10A	10A	7.5A	15A	10A	10A	10A	10A	10A	10A	7.5A	10A			

ONX4090051L

Instrument panel fuse panel

Fuse Name	Symbol	Fuse rating	Circuit Protected
DOOR LOCK		20A	Center Door Lock/Unlock Relay, Dead Lock Relay
P/WINDOW RH	^{RH} 	25A	Power Window Main Switch, Passenger Power Window Switch
P/WINDOW LH	^{LH} 	25A	Power Window Main Switch, Passenger Power Window Switch
S/HEATER REAR	^{REAR} 	20A	Rear Seat Warmer Control Module
S/HEATER DRV/PASS	^{DRV/PASS} 	20A	Front Air Ventilation Seat Control Module, Front Seat Warmer Control Module
P/SEAT PASS	^{PASS} 	30A	Passenger Power Seat Switch, Passenger Seat Relay Unit
BATTERY MANAGEMENT	^{BATTERY MANAGEMENT} 	10A	BMS Control Module
ECS	ECS	15A	ECS Unit
P/WINDOW SAFETY RH	^{SAFETY RH} 	25A	Driver/Passenger Safety Power Window Module, Rear Safety Power Window Module RH
SUNROOF2	² 	20A	Sunroof Controller (Blind Motor)
P/SEAT DRV	^{DRV} 	30A	Driver Power Seat Switch, Driver IMS Module
BATTERY C/FAN	^{BATTERY C/FAN} 	10A	BMS Cooling Fan
AIR BAG2	² 	10A	SRS Control Module
AMP	AMP	15A	AMP, Low DC-DC Converter
MODULE9	⁹ MODULE	10A	Clutch Master Cylinder, Crash Pad Switch, Hazard Switch, Driver/Passenger Smart Key Outside Handle, Rain Sensor, UIP (Ultrasonic Intrusion Protection) Siren, Data Link Connector
SUNROOF1	¹ 	20A	Sunroof Controller (Glass Motor)
IBU2	² IBU	10A	IBU, Ignition Switch, Sport Mode Switch
P/WINDOW SAFETY LH	^{SAFETY LH} 	25A	Driver/Passenger Safety Power Window Module, Rear Safety Power Window Module LH

Fuse Name	Symbol	Fuse rating	Circuit Protected
MEMORY	MEMORY	10A	Outside Mirror Folding/Unfolding Relay, Driver IMS Module, Driver/Passenger Power Outside Mirror, Instrument Cluster, A/C Controller, A/C Control Module, Power Tail Gate Unit, Rear OccupantAlert Alert (ROA) Sensor, Mood Lamp Unit, Crash Pad Mood Lamp, Drive/Passenger Door Mood Lmap, Console Mood Lamp Unit, Low DC-DC Converter
BRAKE SWITCH	BRAKE SWITCH	10A	Stop Lamp Switch, IBU
E-CALL	E-CALL	10A	MTS E-Call Module
MODULE7	⁷ MODULE	7.5A	IBU
TAIL GATE		10A	Tail Gate Relay
MULTIMEDIA1	¹ MULTI MEDIA	15A	Audio, A/V & Navigation Head Unit, Low DC-DC Converter
WASHER		15A	Multifunction Switch
MODULE8	⁸ MODULE	7.5A	Front Air Ventilation Seat Control Module, Front Seat Warmer Control Module, Rear Seat Warmer Control Module
AIR BAG1	¹ 	15A	SRS Control Module
A/CON	A/C	7.5A	E/R Junction Block(RLY.10/11)
MODULE2	² MODULE	15A	Front/Rear USB Charger Connector
MODULE1	¹ MODULE	10A	ADAS Parking ECU, IBU, Audio Keyboard, AMP, A/V & Navigation Keyboard, ower Outside Mirror Switch, Low DC-DC Converter, MTS E-Call Module, Audio, A/V & Navigation Head Unit
MODULE6	⁶ MODULE	10A	Console Switch, Rear A/C Control Switch, EPB Switch, A/T Shift Lever Indicator
IBU1	¹ IBU	7.5A	IBU, BMS Controlmodule
MODULE5	⁵ MODULE	10A	Driver IMS Module, Rear Seat Warmer Control Module, Front Air Ventilation Seat Control Module, AMP, Front Seat Warmer Control Module, Data Link Connector, Audio, A/V & Navigation Head Unit, MTS E-Call Module, A/V & Navigation Keyboard, Low DC-DC Converter, A/C Controller, A/C Control Module, Electro Chromic Mirror, Front Wireless Charger, Head Lamp LH/RH

Fuse Name	Symbol	Fuse rating	Circuit Protected
AIR BAG IND	^{IND} 	7.5A	Instrument Cluster, Overhead Console Lamp
MODULE4	⁴ MODULE	7.5A	IBU, Front View Camera, Crash Pad Switch, ECS Unit, ADAS Parking ECU, Clutch Master Cylinder, 4WD ECU, Dosing Control Unit
E-SHIFTER	E-SHIFTER	7.5A	Electronic Shift Switch, SCU
CLUSTER	CLUSTER	7.5A	Instrument Cluster
MODULE10	¹⁰ MODULE	7.5A	Fuel Filter Heater & Temperature/ Pressure Sensor
MODULE3	³ MODULE	7.5A	Stop Lamp Switch, Overhead Console Lamp, Multifunction Switch, Sport Mode Switch
MDPS *1		7.5A	MDPS*1 Unit
START		10A	Burglar Alarm Relay, Transaxle Range Switch, PCM/ECM IBU, Ignition Switch, E/R Junction Block (RLY.3)

*1: MDPS (Motor Driven Power Steering) is the same as EPS (Electric Power Steering)

*Engine compartment fuse panel
(Engine room junction block)*

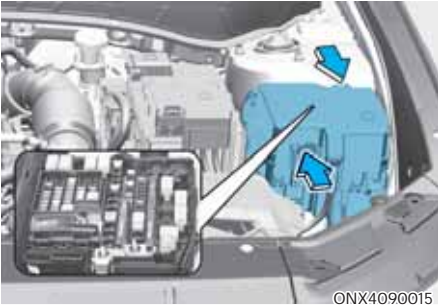







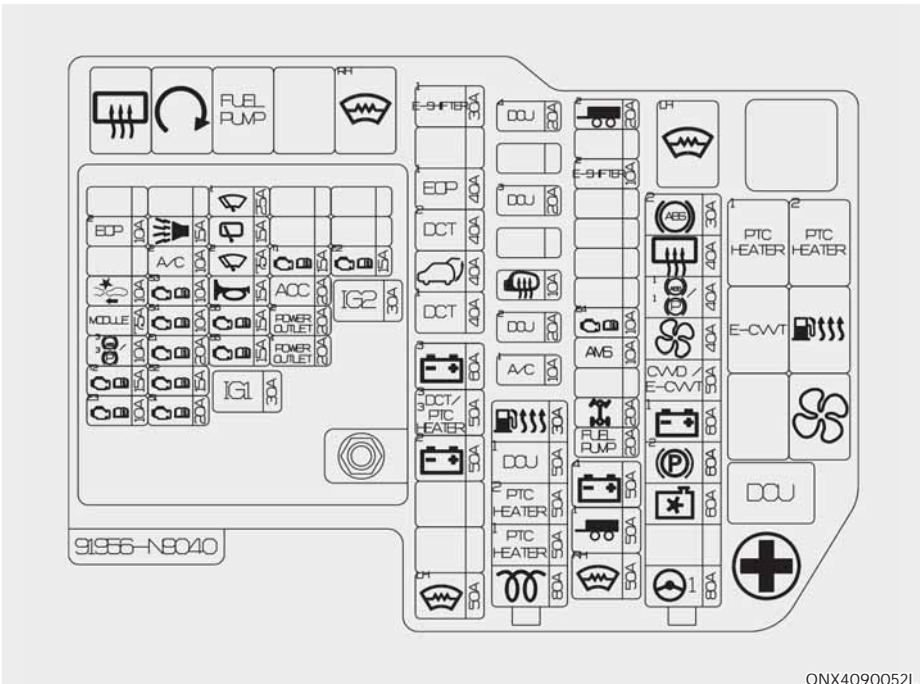





Inside the fuse/relay box cover, you can find the fuse/relay label describing fuse/relay names and ratings.

i Information









Not all fuse panel descriptions in this manual may be applicable to your vehicle; the information is accurate at the time of printing. When you inspect the fuse panel in your vehicle, refer to the fuse panel label.



Engine compartment fuse panel

Type	Fuse Name	Symbol	Fuse rating	Circuit Protected
MULTI FUSE-1	MDPS1 *1	¹  1	80A 100A	[80A : Column Type] : MDPS*1 Unit [100A : Rack Type] : MDPS*1 Unit
	COOLING FAN1	¹ 	80A	[G4FP] Cooling Fan Controller
	COOLING FAN2	² 	60A	[G4NJ/G4KN/D4FE] Cooling Fan Controller
	B+1	¹ 	60A	ICU Junction Block (IPS01/IPS02/IPS03/IPS04/IPS05)
	B+3	³ 	60A	ICU Junction Block (Fuse - F5, F6, F9, F11, F12, F15, F18, Power Window Relay)
	CVVD	CVVD	50A	[G4FP] CVVD Actuator
	E-CVVT	E-CVVT	50A	[G4KN] E/R Junction Block (RLY.4)
	BLOWER		40A	E/R Junction Block (RLY.10)
	ABS1/EPB1	¹  / ¹ 	40A	ABS Control Module, ESP Control Module
	REAR HEATED		40A	E/R Junction Block (RLY.14)
ABS2	² 	30A	ABS Control Module, ESP Control Module	
MULTI FUSE-1	GLOW		80A	[D4FE] GCU
	PTC HEATER1	¹ PTC HEATER	50A	[D4FE] E/R Junction Block (RLY.13)
	PTC HEATER2	² PTC HEATER	50A	[D4FE] E/R Junction Block (RLY.11)
	DCU1	¹ DCU	50A	[D4FE] E/R Junction Block (RLY.9)
	F/FILTER HEATER		30A	[D4FE] E/R Junction Block (RLY.6)









*1: MDPS (Motor Driven Power Steering) is the same as EPS (Electric Power Steering)

Type	Fuse Name	Symbol	Fuse rating	Circuit Protected
FUSE	TRAILER1	¹ 	50A	[G4FP/G4NJ/D4FE] Trailer Connector
	B+4	⁴ 	50A	ICU Junction Block (Fuse - F1, F4, F7, F13, F14, F17, F20, F21, F24, F27 Long Term Load Latch Relay)
	EPB2	² 	60A	ESP Control Module
	FUEL PUMP		20A	E/R Junction Block (RLY.8)
	4WD		20A	4WD ECM
	AMS	AMS	10A	Battery Sensor
	ECU4	^{E4} 	10A	[G4FP/D4FE] ECM
	E-SHIFTER2	² E-SHIFTER	10A	[G4FP/G4KN/D4FE] SCU, Electronic Shift Switch
	TRAILER2	² 	20A	[G4FP/G4NJ/D4FE] Trailer Connector
	A/CON1	¹ A/C	10A	E/R Junction Block (RLY.10), A/C Control Module, [G4NJ] PCM
	DCU2	² DCU	20A	[D4FE] Dosing Control Unit
	HEATED MIRROR		10A	E/R Junction Block (RLY.14), Driver/Passenger Power Outside Mirror, [G4FP/G4NJ] ECM/PCM
	DCU3	³ DCU	20A	[D4FE] Dosing Control Unit
	DCU4	⁴ DCU	20A	[D4FE] Dosing Control Unit
	B+2	² 	50A	ICU Junction Block (IPS06/IPS07/IPS08/IPS09/IPS10/IPS11)
	DCT3	³ DCT	50A	[G4FP/D4FE] SGA

Type	Fuse Name	Symbol	Fuse rating	Circuit Protected
FUSE	DCT1	¹ DCT	40A	[G4FP/D4FE] TCM
	E-CLUTCH	E-CLUTCH	40A	[G4FP/D4FE] Electronic Clutch Module
	TAILGATE		40A	Power Tail Gate Unit
	DCT2	² DCT	40A	[G4FP/D4FE] TCM
	E-SHIFTER1	¹ E-SHIFTER	30A	[G4FP/G4KN/D4FE] SCU

Engine compartment fuse panel (PCB block)

Fuse Name	Symbol	Fuse rating	Circuit Protected
IG1	IG1	30A	PDM (IG1) Relay
IG2	IG2	15A	PDM (IG1) Relay, E/R Junction Block (RLY.3)
ECU3		10A	[G4FP] ECM, CVVD Actuator [G4NJ/G4KN] PCM [D4FE] Oil Level Sensor
TCU2		15A	[G4FP/D4FE] TCM, Transaxle Range Switch, Electronic Clutch Module [G4NJ] Transaxle Range Switch
ABS3	³ 	10A	ABS Control Module, ESP Control Module
MODULE	MODULE	7.5A	[D4FE] GCU
AEB		10A	Front Radar
SENSOR1	^{S1} 	10A	[G4FP/G4NJ/G4KN] Ignition Coil #1-#4 [D4FE] Front/Rear NOX Sensor"
SENSOR2	^{S2} 	15A	[G4FP/G4NJ/G4KN] Oxygen Sensor (UP/DOWN) [D4FE] Electronic VGT Actuator, PTC Heater
ECU1	^{E1} 	20A	[G4FP/D4FE] ECM [G4NJ/G4KN] PCM
SENSOR4	^{S4} 	10A	[G4FP/G4NJ/G4KN] E/R Junction Block (RLY.8) [D4FE] E/R Junction Block (RLY.6, 8)
SENSOR3	^{S3} 	10A	[G4FP] Oil Control Valve (Intake/Exhaust), Variable Oil Pump Solenoid, Purge Control Solenoid Valve, RCV Control Solenoid Valve, Cooling Fan Controller, A/C Comp Relay [G4NJ] Oil Control Valve (Intake/Exhaust), Variable Intake Solenoid Valve, Purge Control Solenoid Valve, RCV Control Solenoid Valve, Cooling Fan Controller, A/C Comp Relay [G4KN] Oil Control Valve, Variable Oil Pump Solenoid, Variable Intake Solenoid Valve, Purge Control Solenoid Valve, Cooling Fan Controller, A/C Comp Relay [D4FE] Oil Control Valve, Cooling Fan Controller, A/C Comp Relay, E/R Junction Block (RLY.13)
A/CON2	² A/C	10A	A/C Comp Relay
B/ALARM HORN		15A	B/Alarm Horn Relay

Fuse Name	Symbol	Fuse rating	Circuit Protected
MDPS2 *1	²  1	10A	MDPS*1 Unit
SENSOR5	^{S5} 	15A	[G4FP] Mild Hybrid Starter & Generator Motor [G4NJ/G4KN] Injector #1~#4 [D4FE] Lambda Sensor (Up/Down), Air Flow Sensor, Oil Pressure Solenoid Valve"
SENSOR6	^{S6} 	15A	[G4FP] ECM [G4NJ] PCM [D4FE] Mild Hybrid Starter & Generator Motor"
HORN		15A	Horn Relay
FR WIPER2	² 	25A	Front Wiper (Low) Relay, ECM, IBU
RR WIPER		15A	Wiper Main Relay, ICU Junction Block (Rear Wiper Relay)
FR WIPER1	¹ 	25A	Wiper Main Relay, Front Wiper (Low) Relay
POWER OUTLET1	¹ POWER OUTLET	20A	Luggage Power Outlet
POWER OUTLET2	² POWER OUTLET	20A	Front Power Outlet
ACC	ACC	20A	ICU Junction Block (Fuse - F33, F36)
TCU1	^{T1} 	15A	[G4FP/D4FE] TCM, Electronic Clutch Module [G4KN] PCM
ECU2	^{T2} 	15A	[G4FP/D4FE] ECM [G4NJ/G4KN] PCM

*1: MDPS (Motor Driven Power Steering) is the same as EPS (Electric Power Steering)

LIGHT BULBS

We recommend that you consult an authorized HYUNDAI dealer to replace most vehicle light bulbs. It is difficult to replace vehicle light bulbs because other parts of the vehicle must be removed before you can get to the bulb. This is especially true for removing the headlamp assembly to get to the bulb(s).

Removing/installing the headlamp assembly can result in damage to the vehicle.



WARNING

- Prior to working on a light, shift to P (Park), apply the parking brake, press ignition switch or Engine Start/Stop button to the LOCK/OFF position and take the key with you when leaving the vehicle to avoid sudden movement of the vehicle and to prevent possible electric shock.
- Be aware the bulbs may be hot and may burn your fingers.

NOTICE

Be sure to replace the burned-out bulb with one of the same wattage rating. Otherwise, it may cause damage to the fuse or electrical wiring system.

NOTICE

To prevent damage, do not clean the headlamp lens with chemical solvents or strong detergents.



Information - Headlamp desiccant (if equipped)

This vehicle is equipped with desiccant to reduce fogging inside the headlamp due to moisture. The desiccant is consumable and its performance may change based on the used period or environment. If fogging inside the headlamp due to moisture continues for a long time, we recommend that you consult an authorized HYUNDAI dealer.



Information

The headlamp and tail lamp lenses could appear frosty if the vehicle is washed after driving or the vehicle is driven at night in wet weather. This condition is caused by temperature difference between the lamp inside and outside and, it does not indicate a problem with your vehicle. When moisture condenses in the lamp, it will be removed after driving with the headlamp on. The removable level may differ depending on lamp size, lamp position and environmental condition. However, if moisture is not removed, we recommend that your vehicle is inspected by an authorized HYUNDAI dealer.

i Information

- A normally functioning lamp may flicker momentarily to stabilize the vehicle's electrical control system. However, if the lamp goes out after flickering momentarily, or continues to flicker, we recommend the system be checked by an authorized HYUNDAI dealer.
- The position lamp may not turn on when the position lamp switch is turned on, but the position lamp and headlamp switch may turn on when the headlamp switch is turned on. This may be caused by network failure or vehicle electrical control system malfunction. If this occurs, we recommend the system be checked by an authorized HYUNDAI dealer.

i Information

The headlamp aiming should be adjusted after an accident or after the headlamp assembly is reinstalled.

i Information

The headlight and tail lamp lenses could appear frosty if the vehicle is washed after driving or the vehicle is driven at night in wet weather. This condition is caused by temperature difference between the lamp inside and outside and, it does not indicate a problem with your vehicle.

When moisture condenses in the lamp, it will be removed after driving with the headlight on. The removable level may differ depending on lamp size, lamp position and environmental condition.

However, if moisture is not removed, we recommend that your vehicle is inspected by an authorized HYUNDAI dealer.

Headlamp, position lamp, turn signal lamp, Daytime Running Light (DRL) replacement

Type A

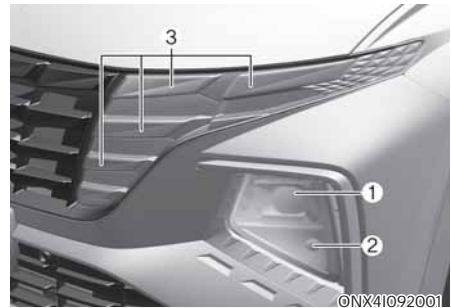

- (1) Headlamp (High/Low)
- (2) Turn signal lamp
- (3) Daytime running light/Position light

Headlamp / Turn signal lamp

1. Engage the parking brake and disconnect the negative battery cable.



2. Remove wheel guard clips (under the front bumper : 4 pieces).

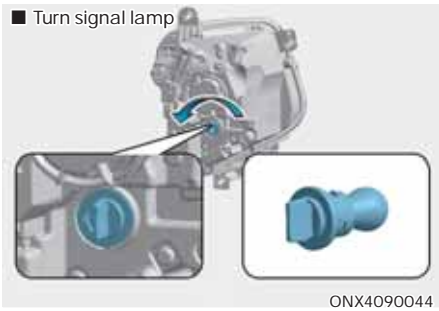
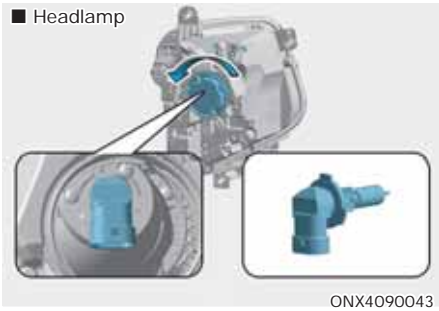

Daytime running light, position light (LED)

If the LED lamp does not operate, we recommend that the system be inspected by an authorized HYUNDAI dealer.

The LED lamps cannot be replaced as a single unit because it is an integrated unit. The LED lamps has to be replaced with the unit.

A skilled technician should check or repair the LED lamp, for it may damage related parts of the vehicle.

3. Push the wheel guard aside and remove the bulb socket by turning it counterclockwise.
4. Remove the bulb from the socket by pressing it in and rotating it counterclockwise until the tabs on the bulb align with the slots in the socket. Pull the bulb out of the socket.
5. Install a new bulb by inserting it into the socket and rotating it until it locks into place.
6. Push the socket into the assembly and turn the socket clockwise.
7. Install the wheel guard in the reverse order.

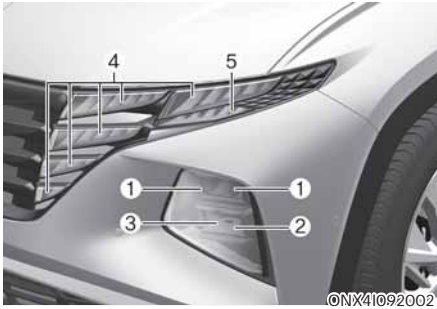
Type B (LED)

- (1) Headlamp (Low)
- (2) Headlamp (High)
- (3) Static bending light/Headlamp (High)
- (4) Daytime running light/Position light
- (5) Turn signal lamp

 **WARNING**

- **Handle halogen bulbs with care. Halogen bulbs contain pressurized gas that will produce flying pieces of glass that could cause injuries if broken.**
- **Wear eye protection when changing a bulb. Allow the bulb to cool down before handling it.**
- Always handle them carefully, and avoid scratches and abrasions. If the bulbs are lit, avoid contact with liquids.
- Never touch the glass with bare hands. Residual oil may cause the bulb to overheat and burst when lit.
- A bulb should be operated only when installed in a headlamp.
- If a bulb becomes damaged or cracked, replace it immediately and carefully dispose of it.

Lamps

If the LED lamp does not operate, we recommend that the system be inspected by an authorized HYUNDAI dealer.

The LED lamps cannot be replaced as a single unit because it is an integrated unit. The LED lamps has to be replaced with the unit.

A skilled technician should check or repair the LED lamp, for it may damage related parts of the vehicle.

Headlamp aiming

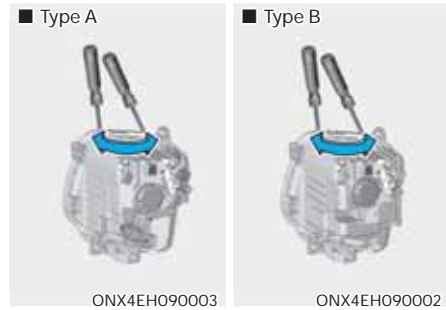

1. Inflate the tires to the specified pressure and remove any loads from the vehicle except the driver, spare tire, and tools.
2. The vehicle should be placed on a flat floor.
3. Draw vertical lines (Vertical lines passing through respective head lamp centers) and a horizontal line (Horizontal line passing through center of head lamps) on the screen.
4. With the headlamp and battery in normal condition, aim the headlamps so the brightest portion falls on the horizontal and vertical lines.
5. To aim the low beam and high beam left or right, turn the driver clockwise or counterclockwise.
To aim the low beam and high beam up or down, turn the driver clockwise or counterclockwise.

Aiming point

■ Hallogen lamp



■ LED lamp



ONX4090048L/ONX4090049L

H1 : Height between the head lamp bulb center and ground (Low beam)

H2 : Height between the head lamp bulb center and ground (High beam)

W1 : Distance between the two head lamp bulbs centers (Low beam)

W2 : Distance between the two head lamp bulbs centers (High beam)

Vehicle condition	Lamp type	H1	H2	W/W2
Without driver	HALOGEN Bi-Function	644	644	1436
	LED MFR.	660	589	1434
With driver	HALOGEN Bi-Function	637	637	1436
	LED MFR.	653	582	1434

Head lamp low beam

■ Based on 10m screen

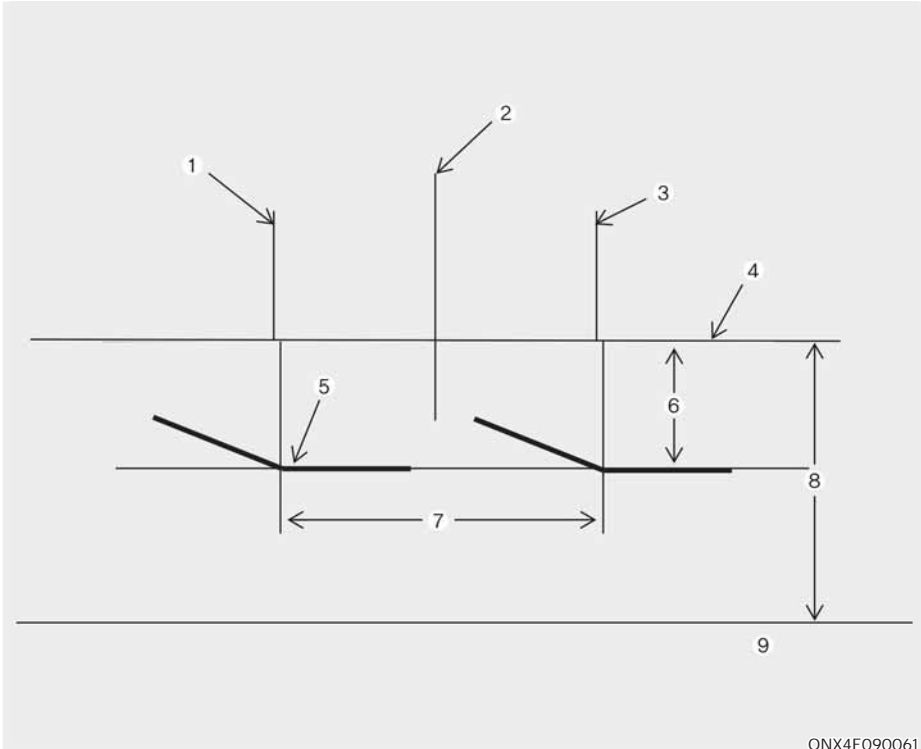

ONX4E090061

- [1] : Vertical line of the left headlamp bulb center
- [2] : Car axis
- [3] : Vertical line of the right headlamp bulb center
- [4] : Horizontal line of headlamp bulb center
- [5] : Cut-off line
- [6] : 100
- [7] : W1 (Low beam)
- [8] : H1 (Low beam)
- [9] : Ground

1. Turn the low beam on without driver aboard.
 2. The cut-off line should be projected in the cut-off line shown in the picture.
 3. When aiming the low beam, vertical aiming should be adjusted after adjusting the horizontal aiming.
 4. If headlamp leveling device is equipped, adjust the head lamp leveling device switch to "0".
- * The high beam is aimed simultaneously when aiming the low beam.

Side repeater lamp replacement



If the LED lamp (1) does not operate, we recommend that the system be inspected by an authorized HYUNDAI dealer.

The LED lamps cannot be replaced as a single unit because it is an integrated unit. The LED lamps has to be replaced with the unit.

A skilled technician should check or repair the LED lamp, for it may damage related parts of the vehicle.

Rear combination lamp replacement

Type A



- (1) Tail lamp
- (2) Tail/Stop lamp
- (3) Turn signal lamp
- (4) Backup lamp (if equipped) or Fog lamp (if equipped)



Stop/Tail lamp (Outside)

1. Turn off the engine.
2. Open the tailgate.
3. Loosen the lamp assembly retaining screws with a cross-tip screwdriver.
4. Remove the rear combination lamp assembly from the body of the vehicle.
5. Remove the socket from the assembly by turning the socket counterclockwise until the tabs on the socket align with the slots on the assembly.

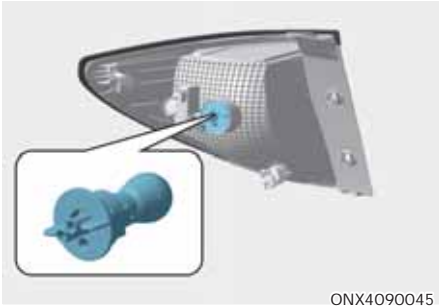

6. Remove the bulb from the socket by pressing it in and rotating it counterclockwise until the tabs on the bulb align with the slots in the socket. Pull the bulb out of the socket.
7. Insert a new bulb by inserting it into the socket and rotating it until it locks into place.
8. Install the socket into the assembly by aligning the tabs on the socket with the slots in the assembly. Push the socket into the assembly and turn the socket clockwise.
9. Reinstall the lamp assembly to the body of the vehicle.



Tail lamp (Inside)

1. Turn off the engine.
2. Open the tailgate.
3. Remove the service cover using a flat-blade screwdriver.
4. Remove the socket from the assembly by turning the socket counterclockwise until the tabs on the socket align with the slots on the assembly.



5. Remove the bulb from the socket by pressing it in and rotating it counterclockwise until the tabs on the bulb align with the slots in the socket. Pull the bulb out of the socket.
6. Insert a new bulb by inserting it into the socket and rotating it until it locks into place.

7. Install the socket into the assembly by aligning the tabs on the socket with the slots in the assembly. Push the socket into the assembly and turn the socket clockwise.
8. Reinstall the lamp assembly to the body of the vehicle.

Turn signal lamp, Rear fog lamp, Back-up lamp

1. Disconnect the negative battery cable.



ONX4E090054

2. Loosen the retaining clips under the bumper and screws on the wheel house trim.
3. Prey trim under the bumper toward the vehicle.

Turn signal lamp

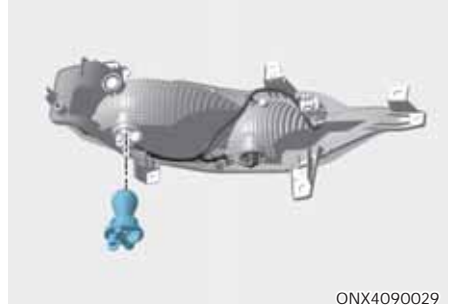

ONX4090029

Rear fog lamp / Back-up lamp

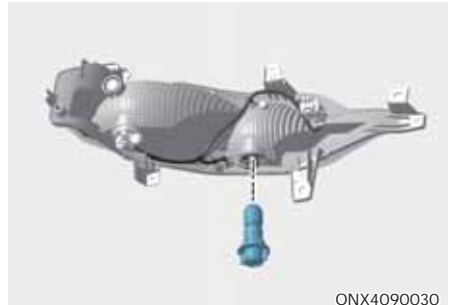

ONX4090030

4. Remove the socket from the assembly by turning the socket counterclockwise until the tabs on the socket align with the slots on the assembly.
5. Remove the bulb by pulling it straight out.
6. Insert a new bulb in the socket.
7. Reinstall the light assembly to the body of the vehicle.

Type B

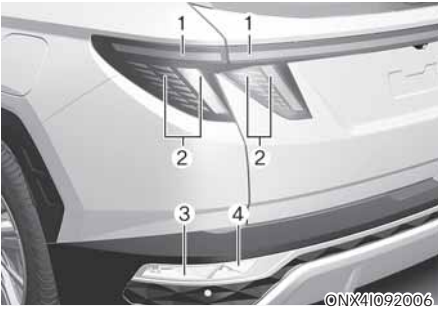

- (1) Tail lamp
- (2) Tail/Stop lamp
- (3) Turn signal lamp
- (4) Backup lamp (if equipped) or Fog lamp (if equipped)

Tail/Stop lamp, Tail lamp

If the LED lamp does not operate, we recommend that the system be inspected by an authorized HYUNDAI dealer.

The LED lamps cannot be replaced as a single unit because it is an integrated unit. The LED lamps has to be replaced with the unit.

A skilled technician should check or repair the LED lamp, for it may damage related parts of the vehicle.

High mounted stop lamp replacement



If the LED lamp (1) does not operate, we recommend that the system be inspected by an authorized HYUNDAI dealer.

The LED lamps cannot be replaced as a single unit because it is an integrated unit. The LED lamps has to be replaced with the unit.

A skilled technician should check or repair the LED lamp, for it may damage related parts of the vehicle.

License plate lamp replacement

License plate lamp (Bulb type)

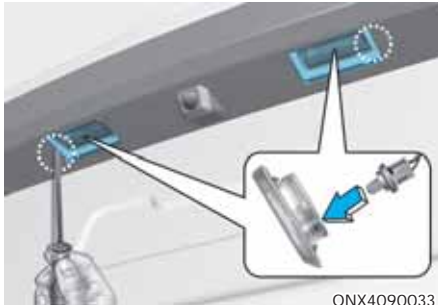

1. Using a flat-blade screwdriver, gently pry the lens cover from the lamp housing.
2. Remove the bulb by pulling it straight out.
3. Install a new bulb.
4. Reinstall in the reverse order.

License plate lamp (LED type)

If the LED lamp does not operate, we recommend that the system be inspected by an authorized HYUNDAI dealer.

The LED lamps cannot be replaced as a single unit because it is an integrated unit. The LED lamps has to be replaced with the unit.

A skilled technician should check or repair the LED lamp, for it may damage related parts of the vehicle.

Interior light replacement

Map/Personal lamp (LED)



If the LED lamp does not operate, we recommend that the system be inspected by an authorized HYUNDAI dealer.

The LED lamps cannot be replaced as a single unit because it is an integrated unit. The LED lamps has to be replaced with the unit.

A skilled technician should check or repair the LED lamp, for it may damage related parts of the vehicle.

Map lamp, Room lamp, Sunvisor lamp and Luggage compartment lamp (Bulb type)

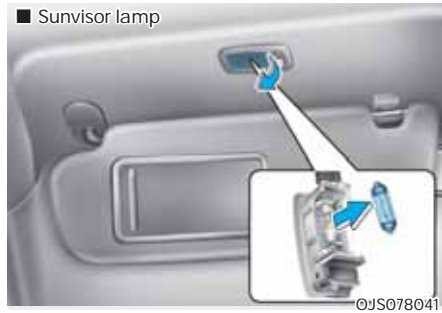
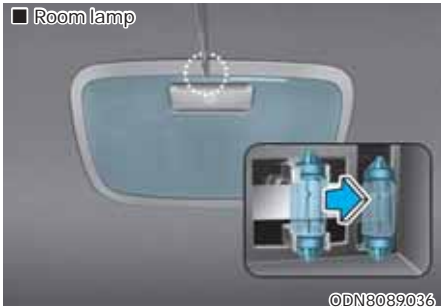

1. Using a flat-head screwdriver, gently pry the lens from the interior light housing.
2. Remove the bulb by pulling it straight out.
3. Install a new bulb into the socket.
4. Align the lens tabs with the interior light housing notches and snap the lens into place.

NOTICE

Be careful not to damage the cover, tab, and plastic housing.

APPEARANCE CARE

Exterior care

NOTICE

If you park your vehicle near a stainless steel sign or glass facade building, the vehicle's exterior plastic parts such as a bumper, spoiler, garnish, lamp or outside rearview mirror might be damaged due to sunlight reflected from the sign or building. To prevent damage of the exterior plastic parts, you should avoid parking in areas where light may be reflected or use a car cover. (The exterior plastic parts applied to your vehicle may vary.)

Exterior general caution

It is very important to follow the label directions when using any chemical cleaner or polish. Read all warning and caution statements that appear on the label.

Finish maintenance

Washing

To help protect your vehicle's finish from rust and deterioration, wash it thoroughly and frequently at least once a month with lukewarm or cold water.

If you use your vehicle for off-road driving, you should wash it after each off-road trip. Pay special attention to the removal of any accumulation of salt, dirt, mud, and other foreign materials. Make sure the drain holes in the lower edges of the doors and rocker panels are kept clear and clean.

Insects, tar, tree sap, bird droppings, industrial pollution and similar deposits can damage your vehicle's finish if not removed immediately.

Even prompt washing with plain water may not completely remove all these deposits. A mild soap, safe for use on painted surfaces, should be used.

After washing, rinse the vehicle thoroughly with lukewarm or cold water. Do not allow soap to dry on the finish.

High-pressure washing

- When using high-pressure washers, make sure to maintain sufficient distance from the vehicle. Insufficient clearance or excessive pressure can lead to component damage or water penetration.
- Do not spray the camera, sensors or its surrounding area directly with a high pressure washer. Shock applied from high pressure water may cause the device to not operate normally.
- Do not bring the nozzle tip close to boots (rubber or plastic covers) or connectors as they may be damaged if they come into contact with high pressure water.



WARNING

After washing the vehicle, test the brakes while driving slowly to see if they have been affected by water before getting on the road. If braking performance is impaired, dry the brakes by applying them lightly while maintaining a slow forward speed.

NOTICE

- Do not use strong soap, chemical detergents or hot water, and do not wash the vehicle in direct sunlight or when the body of the vehicle is warm.
- Be careful when washing the side windows of your vehicle.
- Especially, with high-pressure water, water may leak through the windows and wet the interior.
- To prevent damage to the plastic parts, do not clean with chemical solvents or strong detergents.

NOTICE



- Water washing in the engine compartment including high pressure water washing may cause the failure of electrical circuits located in the engine compartment.
- Never allow water or other liquids to come in contact with electrical/electronic components inside the vehicle as this may damage them.

NOTICE

Matte paint finish vehicle (if equipped)
Automatic car wash which uses rotating brushes should not be used as this can damage the surface of your vehicle. A steam cleaner which washes the vehicle surface at high temperature may result the oil to adhere and leave stains that is difficult to remove.

Use a soft cloth (for example, microfiber towel or sponge) when washing your vehicle and dry with a microfiber towel. When you hand wash your vehicle, you should not use a cleaner that finishes with wax. If the vehicle surface is too dirty (sand, dirt, dust, contaminant, etc.), clean the surface with water before washing the car.

Waxing

A good coat of wax is a barrier between your paint and contaminate. Keeping a good coat of wax on your vehicle will help protect it.

Wax the vehicle when water will no longer bead on the paint.

Always wash and dry the vehicle before waxing. Use a good quality liquid or paste wax, and follow the manufacturer's instructions. Wax all metal trim to protect it and to maintain its luster.

Removing oil, tar, and similar materials with a spot remover will usually strip the wax from the finish. Be sure to re-wax these areas even if the rest of the vehicle does not yet need waxing.

NOTICE

- Wiping dust or dirt off the body with a dry cloth will scratch the finish.
- Do not use steel wool, abrasive cleaners, or strong detergents containing highly alkaline or caustic agents on chrome-plated or anodized aluminum parts. This may result in damage to the protective coating and cause discoloration or paint deterioration.

NOTICE

Matte paint finish vehicle (if equipped)

Do not use any polish protector such as a detergent, an abrasive and a polish. In case wax is applied, remove the wax immediately using a silicon remover and if any tar or tar contaminant is on the surface use a tar remover to clean. However, be careful not to apply too much pressure on the painted area.

Finish damage repair

Deep scratches or stone chips in the painted surface must be repaired promptly. Exposed metal will quickly rust and may develop into a major repair expense.

NOTICE

If your vehicle is damaged and requires any metal repair or replacement, be sure the body shop applies anti-corrosion materials to the parts repaired or replaced.

NOTICE

Matte paint finish vehicle (if equipped)

In case of matte paint finish vehicles, it is impossible to modify only the damaged area and repair of the whole part is necessary. If the vehicle is damaged and painting is required, we recommend that you have your vehicle maintained and repaired by an authorized HYUNDAI dealer. Take extreme care, as it is difficult to restore the quality after the repair.

Bright-metal maintenance

- To remove road tar and insects, use a tar remover, not a scraper or other sharp object.
- To protect the surfaces of brightmetal parts from corrosion, apply a coating of wax or chrome preservative and rub to a high luster.
- During winter weather or in coastal areas, cover the bright metal parts with a heavier coating of wax or preservative. If necessary, coat the parts with non-corrosive petroleum jelly or other protective compound.

Underbody maintenance

Corrosive materials used for ice and snow removal and dust control may collect on the underbody. If these materials are not removed, accelerated rusting can occur on underbody parts such as the fuel lines, frame, floor pan and exhaust system, even though they have been treated with rust protection. Thoroughly flush the vehicle underbody and wheel openings with lukewarm or cold water once a month, after off-road driving and at the end of each winter. Pay special attention to these areas because it is difficult to see all the mud and dirt. It will do more harm than good to wet down the road grime without removing it. The lower edges of doors, rocker panels, and frame members have drain holes that should not be allowed to clog with dirt; trapped water in these areas can cause rusting.



WARNING

After washing the vehicle, test the brakes while driving slowly to see if they have been affected by water. If braking performance is impaired, dry the brakes by applying them lightly while maintaining a slow forward speed.

Aluminum wheel maintenance

The aluminum wheels are coated with a clear protective finish.

- Do not use abrasive cleaner, polishing compound, solvent, or wire brushes on aluminum wheels.
- Clean the wheel when it has cooled.
- Use only a mild soap or neutral detergent, and rinse thoroughly with water. Also, clean the wheels after driving on salted roads.
- Do not wash the wheels with high-speed car wash brushes.
- Do not use any cleaners containing acid or alkaline detergents.

Corrosion protection

Protecting your vehicle from corrosion

By using the most advanced design and construction practices to combat corrosion, HYUNDAI produces vehicles of the highest quality. However, this is only part of the job. To achieve the long-term corrosion resistance your vehicle can deliver, the owner's cooperation and assistance is also required.

Common causes of corrosion

The most common causes of corrosion on your vehicle are:

- Road salt, dirt and moisture that is allowed to accumulate underneath the vehicle.
- Removal of paint or protective coatings by stones, gravel, abrasion or minor scrapes and dents which leave unprotected metal exposed to corrosion.

High-corrosion areas

If you live in an area where your vehicle is regularly exposed to corrosive materials, corrosion protection is particularly important. Some of the common causes of accelerated corrosion are road salts, dust control chemicals, ocean air and industrial pollution.

Moisture breeds corrosion

Moisture creates the conditions in which corrosion is most likely to occur. For example, corrosion is accelerated by high humidity, particularly when temperatures are just above freezing. In such conditions, the corrosive material is kept in contact with the vehicle surfaces by moisture that is slow to evaporate.

Mud is particularly corrosive because it is slow to dry and holds moisture in contact with the vehicle. Although the mud appears to be dry, it can still retain moisture and promote corrosion.

High temperatures can also accelerate corrosion of parts that are not properly ventilated so the moisture can be dispersed. For all these reasons, it is particularly important to keep your vehicle clean and free of mud or accumulations of other materials. This applies not only to the visible surfaces but particularly to the underside of the vehicle.

To help prevent corrosion

Keep your vehicle clean

The best way to prevent corrosion is to keep your vehicle clean and free of corrosive materials. Attention to the underside of the vehicle is particularly important.

- If you live in a high-corrosion area — where road salts are used, near the ocean, areas with industrial pollution, acid rain, etc.—, you should take extra care to prevent corrosion. In winter, hose off the underside of your vehicle at least once a month and be sure to clean the underside thoroughly when winter is over.
- When cleaning underneath the vehicle, pay particular attention to the components under the fenders and other areas that are hidden from view. Do a thorough job; just dampening the accumulated mud rather than washing it away will accelerate corrosion rather than prevent it. Water under high pressure and steam are particularly effective in removing accumulated mud and corrosive materials.
- When cleaning lower door panels, rocker panels and frame members, be sure that drain holes are kept open so that moisture can escape and not be trapped inside to accelerate corrosion.

Keep your garage dry

Don't park your vehicle in a damp, poorly ventilated garage. This creates a favorable environment for corrosion. This is particularly true if you wash your vehicle in the garage or drive it into the garage when it is still wet or covered with snow, ice or mud. Even a heated garage can contribute to corrosion unless it is well ventilated so moisture is dispersed.

Keep paint and trim in good condition

Scratches or chips in the finish should be covered with "touch-up" paint as soon as possible to reduce the possibility of corrosion. If bare metal is showing through, the attention of a qualified body and paint shop is recommended.

Bird droppings are highly corrosive and may damage painted surfaces in just a few hours. Always remove bird droppings as soon as possible.

Interior care

Interior general precautions

Prevent caustic solutions such as perfume and cosmetic oil, from contacting the interior parts because they may cause damage or discoloration. If they do contact the interior parts, wipe them off immediately. See the instructions for the proper way to clean vehicle interior surfaces.

NOTICE

- **Never allow water or other liquids to come in contact with electrical/electronic components inside the vehicle as this may damage them.**
- **When cleaning leather products (steering wheel, seats etc.), use neutral detergents or low alcohol content solutions. If you use high alcohol content solutions or acid/alkaline detergents, the color of the leather may fade or the surface may get stripped off.**

Cleaning the upholstery and interior trim

Vehicle interior surfaces (if equipped)

Remove dust and loose dirt from interior surfaces with a whisk groom or a vacuum cleaner. If necessary, clean interior surfaces with a mixture of warm water and mild non-detergent cleaner (test all cleaners on a concealed area before use).

Fabric (if equipped)

Remove dust and loose dirt from fabric with a whisk broom or vacuum cleaner. Clean with a mild soap solution recommended for upholstery or carpets. Remove fresh spots immediately with a fabric spot cleaner. If fresh spots do not receive immediate attention, the fabric can be stained and its color can be affected. Also, its fire-resistant properties can be reduced if the material is not properly maintained.

NOTICE

Using anything but recommended cleaners and procedures may affect the fabric's appearance and fire-resistant properties.

Leather (if equipped)

- Features of seat leather
 - Leather is made from the outer skin of an animal, which goes through a special process to be available for use. Since it is a natural product, each part differs in thickness or density.
Wrinkles may appear as a natural result of stretching and shrinking depending on the temperature and humidity.
 - The seat is made of stretchable fabric to improve comfort.
 - The parts contacting the body are curved and the side supporting area is high which provides driving comfort and stability.
 - Wrinkles may appear naturally from usage. It is not a fault of the products.

NOTICE

- **Wrinkles or abrasions which appear naturally from usage are not covered by warranty.**
 - **Belts with metallic accessories, zippers or keys inside the back pocket may damage the seat fabric.**
 - **Make sure not to wet the seat. It may change the nature of natural leather.**
 - **Jeans or clothes which could bleach may contaminate the surface of the seat covering fabric.**
- Caring for the leather seats
 - Vacuum the seat periodically to remove dust and sand on the seat. It will prevent abrasion or damage of the leather and maintain its quality.
 - Wipe the natural leather seat cover often with dry or soft cloth.
 - Use of proper leather protector may prevent abrasion of the cover and helps maintain the color. Be sure to read the instructions and consult a specialist when using leather coating or protective agent.
 - Light colored (beige, cream beige) leather is easily contaminated and the stain is noticeable. Clean the seats frequently.
 - Avoid wiping with wet cloth. It may cause the surface to crack.
 - Cleaning the leather seats
 - Remove all contaminations instantly. Refer to instructions below for removal of each contaminant.
 - Cosmetic products (sunscreen, foundation, etc.)
Apply cleansing cream on a cloth and wipe the contaminated spot. Wipe off the cream with a wet cloth and remove water with a dry cloth.
 - Beverages (coffee, soft drink, etc.)
Apply a small amount of neutral detergent and wipe until contaminations do not smear.

- Oil
Remove oil instantly with absorbable cloth and wipe with stain remover used only for natural leather.
- Chewing gum
Harden the gum with ice and remove gradually.
- Handling prime napa leather (if equipped)
Try to avoid excessive sunlight and heat exposure. Excessive sunlight and heat exposure naturally fades and dries out napa leather, causing wrinkles and discoloration. If the napa leather is wet with liquid, immediately clean it with lint-free cloth to minimize damage. Do not scratch the napa leather surface with a sharp object. If your napa leather seat is bright colored, it may be contaminated or stained from dyed materials such as jeans.
- Sharp objects (for example, driver, knife), adhesive materials, or tapes may damage the interior wooden trim.
- Any strong impacts may damage the interior wooden trim.
- If the coating finish over the interior wooden trim is removed, moisture may damage or change wood traits.
- If the interior wooden trim is damaged, you may get a splinter from the wood surface. Therefore, we recommended to contact the nearest authorized HYUNDAI dealer to have the damaged interior wooden trim replaced.

Interior wooden trim

- Use a wooden furniture protector (for example, wax, coating compound) to clean the interior wooden trim.
- Often wipe the interior wooden trim with a lint-free, clean cloth to maintain the unique wooden textures for a longer period of time.
- If you spill beverage (for example, water, coffee) over the interior wooden trim, immediately wipe it with clean, dry cloth.

Cleaning the seat belt webbing

Clean the belt webbing with any mild soap solution recommended for cleaning upholstery or carpet. Follow the instructions provided with the soap. Do not bleach or re-dye the webbing because this may weaken the seat belt.

Cleaning the interior window glass

If the interior glass surfaces of the vehicle become fogged (that is, covered with an oily, greasy or waxy film), they should be cleaned with glass cleaner. Follow the directions on the glass cleaner container.

NOTICE

Do not scrape or scratch the inside of the rear window. This may result in damage to the rear window defroster grid.

EMISSION CONTROL SYSTEM

The emission control system of your vehicle is covered by a written limited warranty. Please see the warranty information contained in the Service Passport in your vehicle.

Your vehicle is equipped with an emission control system to meet all applicable emission regulations. There are three emission control systems, as follows.

- (1) Crankcase emission control system
- (2) Evaporative emission control system
- (3) Exhaust emission control system

In order to ensure the proper function of the emission control systems, it is recommended that you have your vehicle inspected and maintained by an authorized HYUNDAI dealer in accordance with the maintenance schedule in this manual.

NOTICE

For the Inspection and Maintenance Test (with Electronic Stability Control (ESC) system)

- **To prevent the vehicle from misfiring during dynamometer testing, turn the Electronic Stability Control (ESC) system off by pressing the ESC switch (ESC OFF light illuminated).**
- **After dynamometer testing is completed, turn the ESC system back on by pressing the ESC switch again.**

1. Crankcase emission control system

The positive crankcase ventilation system is employed to prevent air pollution caused by blow-by gases being emitted from the crankcase. This system supplies fresh filtered air to the crankcase through the air intake hose. Inside the crankcase, the fresh air mixes with blow-by gases, which then pass through the PCV valve into the induction system.

2. Evaporative emission control system

The Evaporative Emission Control System is designed to prevent fuel vapors from escaping into the atmosphere.

Canister

Fuel vapors generated inside the fuel tank are absorbed and stored in the onboard canister. When the engine is running, the fuel vapors absorbed in the canister are drawn into the surge tank through the purge control solenoid valve.

Purge Control Solenoid Valve (PCSV)

The purge control solenoid valve is controlled by the Engine Control Module (ECM); when the engine coolant temperature is low during idling, the PCSV closes so that evaporated fuel is not taken into the engine. After the engine warms-up during ordinary driving, the PCSV opens to introduce evaporated fuel to the engine.

1. Exhaust emission control system

The Exhaust Emission Control System is a highly effective system which controls exhaust emissions while maintaining good vehicle performance.

When the engine starts or fails to start, excessive attempts to restart the engine may cause damage to the emission system.

Engine exhaust (carbon monoxide) precautions

- Carbon monoxide can be present with other exhaust fumes. If you smell exhaust fumes of any kind in your vehicle, drive with all the windows fully open. Have your vehicle checked and repaired immediately.



WARNING

Engine exhaust gases contain carbon monoxide (CO). Though colorless and odorless, it is dangerous and could be lethal if inhaled. Follow the instructions on this page to avoid CO poisoning.

- Do not operate the engine in confined or closed areas (such as garages) any more than what is necessary to move the vehicle in or out of the area.
- When the vehicle is stopped in an open area for more than a short time with the engine running, adjust the ventilation system (as needed) to draw outside air into the vehicle.
- Never sit in a parked or stopped vehicle for any extended time with the engine running.
- When the engine stalls or fails to start, excessive attempts to restart the engine may cause damage to the emission control system.

Operating precautions for catalytic converters (if equipped)



WARNING

The exhaust system and catalytic system are very hot while the engine is running or immediately after the engine is turned off. To avoid **SERIOUS INJURY or DEATH**:

- Do not park, idle, or drive the vehicle over or near flammable objects, such as grass, vegetation, paper, leaves, etc. A hot exhaust system can ignite flammable items under your vehicle.
- Keep away from the exhaust system and catalytic converter or you may get burned.

Also, do not remove the heat sink around the exhaust system, do not seal the bottom of the vehicle, and do not coat the vehicle for corrosion control. It may present a fire risk under certain conditions.

Your vehicle is equipped with a catalytic converter emission control device.

To prevent damage to the catalytic converter and to your vehicle, take the following precautions:

- Use only UNLEADED FUEL for gasoline engines.
- Do not operate the vehicle when there are signs of engine malfunction, such as misfire or a noticeable loss of performance.
- Do not misuse or abuse the engine. Examples of misuse are coasting with the engine off and descending steep grades in gear with the engine off.

- Do not operate the engine at high idle speed for extended periods (5 minutes or more).
- Do not modify or tamper with any part of the engine or emission control system. We recommend that all inspections and adjustments are made by an authorized HYUNDAI dealer.
- Avoid driving with an extremely low fuel level.
Running out of fuel could cause the engine to misfire, damaging the catalytic converter.

Gasoline Particulate Filter (GPF) (if equipped)

Gasoline Particulate Filter (GPF) system removes the soot in the exhaust gas.

The GPF system automatically burns (or oxidizes) the accumulated soot in accordance with driving situations, unlike a disposable air filter.

In other words, the accumulated soot is automatically purged out by the engine control system and by the high exhaust-gas temperature at normal/ high driving speeds.

However, when the vehicle is continually driven at repeated short distances or driven at low speed for a long time, the accumulated soot may not be automatically removed because of low exhaust gas temperature. In this case, the accumulated soot may reach a certain amount regardless of the soot oxidation process, then the GPF lamp () will illuminate.

The Gasoline Particulate Filter (GPF) lamp stops illuminating, when the driving speed exceeds 80 km/h (50 mph) with engine rpm 1,500 ~ 4,000 and the gear in the 3rd position or above for approximately 30 minutes.

When the GPF lamp starts to blink or the warning message "Check exhaust system" pops up even though the vehicle was driven as mentioned above, we recommend that you have the GPF system checked by an authorized HYUNDAI dealer.

With GPF lamp blinking for an extended period of time, it may damage the GPF system and lower the fuel economy.



CAUTION

We recommend you to use only the regulated gasoline fuels, when your vehicle is equipped with the GPF system.

When you use other gasoline fuels which contain unspecified additives, they may damage the GPF system and cause exhaust emission problems.

Diesel Particulate Filter (DPF) (if equipped)

Diesel Particulate Filter (DPF) system removes the soot in the exhaust gas.

The DPF system automatically burns (or oxidizes) the accumulated soot in accordance with driving situations, unlike a disposable air filter. In other words, the accumulated soot is automatically purged out by the engine control system and by the high exhaust-gas temperature at normal/high driving speeds.

However, when the vehicle is continually driven at repeated short distances or driven at low speed for a long time, the accumulated soot may not be automatically removed because of low exhaust gas temperature.

If this occurs, the accumulated soot is out of the detection range, the soot oxidization process does not occur, and the Diesel Particulate Filter (DPF) lamp  illuminates.

The Diesel Particulate Filter (DPF) lamp stops illuminating, when the driving speed exceeds 60 km/h (37 mph), or when the engine rpm is between 1,250 and 2,500 with the gear in the 2nd position or above for approximately 25 minutes.

When the DPF lamp continuously blinks or the warning message "Check exhaust system" pops up even though the vehicle was driven as mentioned above, we recommend that you have the DPF system checked by an authorized HYUNDAI dealer.

When the vehicle is continuously driven with the DPF lamp blinking for an extended period of time, it may damage the DPF system and lower the fuel economy.



CAUTION

We recommend you to use only the regulated diesel fuels, when your vehicle is equipped with the DPF system.

When you use other diesel fuels which are high in sulfurs (above 10 ppm) or that contain unspecified additives, they may damage the DPF system and cause white smoke emissions.

Lean NOx Trap (for diesel engine) (if equipped)

Lean NOx Trap (LNT) system removes nitrogen oxide from the exhaust gas. A smell can occur in the exhaust gas depending on the quality of the fuel, and it can degrade NOx reduction performance. Please use regulated automotive diesel fuel.

Selective Catalytic Reduction (SCR) (for diesel engine) (if equipped)

Selective Catalytic Reduction system catalytically converts NOx to nitrogen and water by using reduction agent, urea solution.

DEF level / Urea level

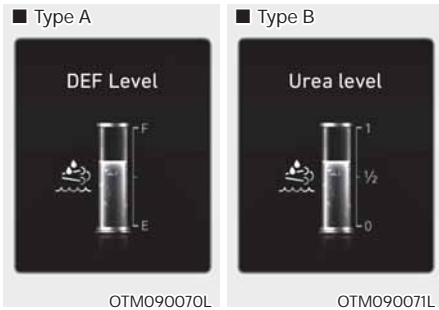

DEF (Diesel Exhaust Fluid) level gauge display shows the approximate amount of remaining urea solution inside the urea solution tank.

You can check the DEF level in the Utility view on the cluster.

Refer to “View Modes” section in chapter 4.

Low urea warning message

Warning message will appear in four steps on the cluster according to urea solution level in the tank.



First warning

The SCR () warning light and 'Low urea' warning message appears on the instrument cluster when urea level is low. Refill as soon as possible.



Second warning

If urea is not refilled after the first warning, the SCR () warning light and 'Refill urea' warning message appears on the instrument cluster when urea level is low. Refill as soon as possible.



OJX1099042L

Third warning

The SCR (🔥) warning light and 'Refill urea in 000 km or vehicle will not start / Refill urea in 000 km. Otherwise vehicle will not start' warning message appears on the instrument cluster when urea solution tank is nearly empty. Refill immediately.

The displayed driving distance (000 km) and actual driving distance may vary depending on driving habits and driving conditions.



OJX1099044L

Fourth warning

The SCR (🔥) warning light and 'Refill urea tank or vehicle will not start / Refill urea tank. Otherwise vehicle will not start' warning message appears on the instrument cluster when urea solution tank is empty. The vehicle cannot be restarted once the engine is turned off. Refill immediately.

Selective Catalytic Reduction system malfunction

When there is a problem with the Selective Catalytic Reduction system such as disconnected electrical components, use of incorrect urea, etc., the following warning message will appear on the instrument cluster. If this occurs, we recommend that the system be inspected by an authorized HYUNDAI dealer.

If you continue to drive without the problem solved, it may adversely effect system performance or the vehicle cannot be restarted once the engine is turned off.

	Malfunction	Driving 50 km after malfunction
Urea system failure (= no urea injection)	Diesel Exhaust Fluid (DEF) system failure / Urea dosing system error	Check urea system
Incorrect urea detected (= abnormal urea)	Incorrect urea detected	Refill with correct urea in 000 km or vehicle will not start / Refill correct urea in 000 km. Otherwise vehicle will not start
Abnormal urea consumption (= post treatment failure)	Check urea system	Service urea system in 000 km or vehicle will not start / Service urea system in 000 km. Otherwise vehicle will not start

Restarting the vehicle

Vehicle restart restriction	
Low urea level	Refill urea tank or vehicle will not start / Refill urea tank. Otherwise vehicle will not start
Urea system failure (= no urea injection)	Service urea system in 000 km or vehicle will not start / Service urea system in 000 km. Otherwise vehicle will not start
Incorrect urea detected (= abnormal urea)	Refill with correct urea in 000 km or vehicle will not start / Refill with correct urea in 000 km. Otherwise vehicle will not start
Abnormal urea consumption (= post treatment failure)	Service urea system in 000 km or vehicle will not start / Service urea system in 000 km. Otherwise vehicle will not start

The vehicle can be restarted after the problem is solved. If the 'Refill urea tank or vehicle will not start / Refill urea tank. Otherwise vehicle will not start' warning message appears, refill the urea solution tank. After refilling the tank, place ignition switch or Engine Start/Stop button to the ON position and wait until the message disappears. If the vehicle cannot be restarted after refilling urea, we recommend that the system be inspected by an authorized HYUNDAI dealer.

Adding urea solution



Refilling urea with a refill hose

1. Turn the vehicle off.
2. Ensure the all doors are unlocked.
3. Press the rear center edge of the fuel filler door.
4. Pull the fuel filler door outward to access the fuel tank cap.
5. To open the urea solution tank cap, turn it counterclockwise.
6. Fully insert the refill hose and add urea.
Do not overfill.
7. To close the urea solution tank cap, turn it clockwise.

Refilling urea from a refill bottle

1. Turn the vehicle off.
2. Ensure the all doors are unlocked.
3. Press the rear center edge of the fuel filler door.
4. Pull the fuel filler door outward to access the fuel tank cap.
5. To open the urea solution tank cap, turn it counterclockwise.
6. Add urea. Do not overfill.
7. To close the urea solution tank cap, turn it clockwise.

Use only specified urea solution (Refer to “Recommended Lubricants and Capacities” section in chapter 2).

NOTICE

To prevent damage to your vehicle:

- Use only specified urea solution. Never add any other urea solution than what has been specified.
- Be careful not to add urea solution into the fuel tank.
- While adding urea, be careful not to allow foreign substances to enter into the urea solution tank.
- Do not mix water or additives with the urea solution.
- Do not over fill the urea solution tank. In cold weather, the tank will expand if the urea freezes.

Storing urea solution

- Store urea solution only in containers made with the following materials.
 - DIN EN 10 088-1/-2/-3-specified CR-Ni steel
 - Mo-Cr-Ni steel
 - Polypropylene
 - Polyethylene
- Do not store urea solution in containers made with the following materials.
 - Aluminum, copper, copper alloy, non-alloyed still, and galvanized steel

Urea solution dissolves the metal materials, severely damaging the exhaust purification system.

Information

Urea solution is a water-soluble substance, which is inflammable, non-toxic, colorless and odorless.

NOTICE

- The following situations may damage the DPF system.
 - Fuels or any unauthorized liquids are added to the urea solution tank
 - Additives are mixed in the urea solution
 - Water is mixed in the urea solution
- Use only specified urea solution.
When any unauthorized urea solution is added to the tank, we recommend that you contact an authorized HYUNDAI dealer.
- When any foreign substances enter the urea solution tank, the following problems may occur.
 - Increased emission
 - DPF system malfunction
 - Engine failure

- Never add used urea solution as its quality cannot be guaranteed. Always add new urea solution.

WARNING

- Do not apply any external impact on the DPF system. It may damage the catalyst, which is equipped inside the DPF system.
- Do not modify the DPF system by redirecting or lengthening the exhaust pipe. It may adversely effect the DPF system.
- Avoid contact with the drained water from the exhaust pipe. The water is slightly acid and harmful to skin. If contacted, thoroughly wash it off.
- Any modification of the DPF system may cause system malfunction. The DPF system is controlled by a complex device.
- Wait for the DPF system to cool down before maintenance, as it is hot due to heat generation. Otherwise, it may cause skin burn.
- The Selective Catalytic Reduction system (for example, urea solution nozzle, urea solution pump, and DCU) operates for approximately 2 minutes more to eliminate the remaining urea solution inside, even after the engine is turned OFF. Before working on the vehicle, make sure that the Selective Catalytic Reduction system is completely turned OFF.
- Poor urea solution or unauthorized liquids may damage vehicle components, including the DPF system. Any unverified additives in the urea solution may clog the SCR catalyst and cause other malfunctions, which require the expensive DPF system to be replaced.

**WARNING**

- When the urea solution contacts with the eyes or the skin, you should thoroughly wash the contaminated skin area.
- When you swallow the urea solution, thoroughly rinse your mouth and drink a lot of fresh water. Then, immediately consult a doctor.
- When your cloth is contaminated with the urea solution, immediately change your cloth.
- When you have an allergic reaction to the urea solution, immediately consult a doctor.
- Keep children away from urea solution.
- When opening the urea solution tank cap at high outside temperatures, ammonia vapors may escape. Ammonia vapors have a pungent smell and primarily cause irritation of the:
 - Skin
 - Mucous membranes
 - Eyes

You may experience a burning sensation in your eyes, nose and throat, as well as coughing and watering of the eyes. Do not inhale ammonia vapors. Do not allow urea solution to come in direct contact with your skin. It is hazardous to your health. Wash any affected areas off with plenty of clean water. If necessary, consult a doctor.
- When handling urea solution in closed space, ensure good ventilation. When the bottle of urea solution container is opened, pungent smelling fumes may escape

NOTICE

- Wipe off any urea solution spillage with water or dampened cloth. When the urea solution is crystalized, wipe it off with sponge or cloth, which is dampened in cold water.

When the urea solution spillage is exposed in the air for an extended period of time, it is crystalized in white, damaging the vehicle surface.
- When urea solution overflows onto vehicle surface, wash out vehicle surface with clean water to prohibit corrosion from occurring.
- Store the urea solution tank only in well ventilated locations. When urea solution is exposed to hot temperature at approximately 50°C (122°F) for an extended period of time (for example, under direct sunlight), chemical decomposition may occur, emitting ammonia vapor.
- In case the vehicle was parked at very low ambient temperature (below 11°C (33°F) for a long time, the urea solution will be frozen in the urea solution tank. With frozen urea, the tank level may not be detected correctly until the urea solution melts. Incorrect urea or diluted urea may increase the freezing point, so only use specified urea solution.

The time for the urea solution to melt varies in accordance with driving conditions and outside temperatures.

